

# Panasonic®

## Operating Instruction

**Operations and Settings**

4K Integrated Camera

Model No. **AW-UE4KG**  
Model No. **AW-UE4KGN**  
Model No. **AW-UE4WG**  
Model No. **AW-UE4WGN**

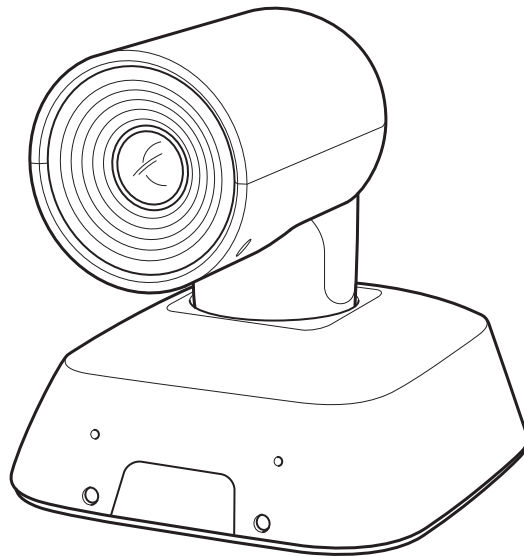

**HDMI™**

Operations and Settings  
Operating Instructions

This "Operations and Settings" describes how to operate the unit and how to establish its settings.  
For more information on how to perform basic operation and installation, refer to the Operating Instructions "Basics".

## Trademarks and Registered Trademarks

- Microsoft®, Windows®, Windows® 7, Windows® 10, Microsoft Edge, Internet Explorer® are either registered trademarks or trademarks of Microsoft Corporation in the United States and other countries.
- Apple, Mac, macOS, OS X and Safari are registered trademarks of Apple Inc., in the United States and other countries.
- Google Chrome™ browser is trademarks of Google LLC.
- Intel® and Intel® Core™ are trademarks or registered trademarks of Intel Corporation in the United States and other countries.
- Adobe® and Reader® are either registered trademarks or trademarks of Adobe Systems Incorporated in the United States and/or other countries.
- The terms HDMI and HDMI High-Definition Multimedia Interface, and the HDMI Logo are trademarks or registered trademarks of HDMI Licensing Administrator, Inc. in the United States and other countries.
- Other names of companies and products contained in these Operating Instructions may be trademarks or registered trademarks of their respective owners.

## About Copyright and License

Distributing, copying, disassembling, reverse compiling, reverse engineering, and also exporting in violation of export laws of the software provided with this unit are expressly prohibited.

## Abbreviations

For the purposes of this manual, the model numbers of the units are given as listed in the table below.

Model number of unit	Model number given in manual
AW-UE4KG, AW-UE4WG AW-UE4KGN, AW-UE4WGN	AW-UE4
AW-RP60G	AW-RP60

## Illustrations and screen displays featured in the manual

What is shown in the manual's illustrations and screen displays may differ from how it is actually appears.

## **Disclaimer of Warranty**

IN NO EVENT SHALL Panasonic Connect Co., Ltd. BE LIABLE TO ANY PARTY OR ANY PERSON, EXCEPT FOR REPLACEMENT OR REASONABLE MAINTENANCE OF THE PRODUCT, FOR THE CASES, INCLUDING BUT NOT LIMITED TO BELOW:

1. ANY DAMAGE AND LOSS, INCLUDING WITHOUT LIMITATION, DIRECT OR INDIRECT, SPECIAL, CONSEQUENTIAL OR EXEMPLARY, ARISING OUT OF OR RELATING TO THE PRODUCT;
2. PERSONAL INJURY OR ANY DAMAGE CAUSED BY INAPPROPRIATE USE OR NEGLIGENT OPERATION OF THE USER;
3. UNAUTHORIZED DISASSEMBLE, REPAIR OR MODIFICATION OF THE PRODUCT BY THE USER;
4. INCONVENIENCE OR ANY LOSS ARISING WHEN IMAGES ARE NOT DISPLAYED, DUE TO ANY REASON OR CAUSE INCLUDING ANY FAILURE OR PROBLEM OF THE PRODUCT;
5. ANY PROBLEM, CONSEQUENTIAL INCONVENIENCE, OR LOSS OR DAMAGE, ARISING OUT OF THE SYSTEM COMBINED BY THE DEVICES OF THIRD PARTY;
6. ANY DEMANDS FOR COMPENSATION, CLAIMS, ETC. OCCASIONED BY THE INFRINGEMENT OF PRIVACY BY INDIVIDUALS OR ORGANIZATIONS WHOSE IMAGES WERE SHOT BY THE USER BECAUSE THESE IMAGES (INCLUDING THE RECORDINGS MADE) WERE MADE AVAILABLE BY THE USER BECAUSE IN THE PUBLIC DOMAIN. FOR SOME REASON OR OTHER OR BECAUSE THE IMAGES ENDED UP BEING USED FOR PURPOSES OTHER THAN THE ONE DESCRIBED ABOVE;
7. LOSS OF REGISTERED DATA CAUSED BY ANY FAILURE.

# Contents

Getting Started .....	8
Required Personal Computer Environment .....	8
Network security.....	9
Characteristics .....	10
Accessories.....	11
Optional Accessories.....	11
Operating Precautions .....	12
Names and Functions of Parts .....	14
Tilting the Camera Up and Down.....	15
Panning the Camera Right and Left .....	15
Wireless Remote Control(optional accessory) .....	16
Network Settings.....	19
Use the Easy IP setup Software .....	19
Setting the Initial Account.....	21
Basic Shooting Operation .....	22
Power on and Power Off the Camera Unit .....	23
Power on the Camera Unit.....	23
Power off the Camera Unit.....	23
Priority Mode.....	24
Selecting the Camera Unit.....	28
Selecting Scene Mode.....	28
Scene Mode Type .....	28
How to select the Scene mode .....	28
Operating the Camera unit .....	30
Control the Picture's Direction (using the wireless remote control) .....	30
Zoom In/Out Function (using the wireless remote control) .....	30
Switching the Direction or Zoom Speed (using the wireless remote control) .....	30
Control the Picture's Direction (using the controller).....	30
Zoom In/Out Function (using the controller) .....	30
Switching the Direction or Zoom Speed (using the controller).....	30
What to do when Encountering Problems in the Basic Shooting Operations.....	31
Advanced Operations .....	32
Preset Memories .....	32
Adjust the White Balance .....	33
Automatic Adjustment (AWB: AWB A or AWB B).....	33

Auto Tracking White Balance Adjustment (ATW) .....	34
3200K and 5600K Presets.....	34
Menu Operation .....	35
Operations Table .....	35
When performing the operations using the wireless remote control.....	35
Menu Items .....	37
Main Menu Screen .....	37
Camera Menu.....	37
Scene.....	38
Picture Level.....	39
AGC Max Gain .....	39
Slow Shutter .....	39
Shutter Speed.....	39
Gain .....	40
Chroma Level .....	40
White Balance Mode .....	40
Detail.....	40
Contrast .....	41
DRS .....	41
Back Light COMP .....	41
DNR.....	41
LDC.....	41
System Menu .....	42
Priority Mode .....	42
Frequency.....	43
Format .....	44
Install Position .....	44
Mirror .....	45
Digital Zoom .....	45
Tally.....	45
Wireless ID .....	45
OSD of with Tally .....	46
Color Bar .....	46
Mic .....	46
Maintenance Menu.....	47
Language.....	47

FW Version .....	47
IP Address .....	47
Subnet Mask.....	48
Default Gateway .....	48
MAC Address.....	48
Initialize.....	48
Menu Table.....	49
Web Screen Start-up.....	51
Connecting to Web Screen by Using a PC .....	52
Switching between Live and Setup Screen.....	53
Web Live Screen Operation.....	54
Web Screen Configuration.....	56
Select the Setup Screen .....	56
Basic Settings.....	57
Selecting Priority Mode.....	57
Live Page (Camera Title).....	58
Clock settings tab (Date&Time).....	59
Image/Audio Settings .....	60
Video over IP .....	60
Image Settings.....	62
System Settings.....	66
User Mng.(User Management).....	69
User auth.(User authentication) .....	69
Network Settings .....	71
Network .....	71
RTMP Setting .....	73
NTP.....	74
Maintenance Settings.....	76
Language.....	76
Product Info. ....	77
Upgrading the firmware (Firmware file) .....	78
Default Reset.....	79
Web Camera Functions .....	80
Controllable functions .....	80
Troubleshooting .....	82
Operation.....	82

Video.....	84
IP images.....	85
USB .....	85
Specification.....	86
Index .....	89

# Getting Started

---

## Required Personal Computer Environment

<b>CPU</b>	Intel® Core™ i5 3.2 GHz or higher (Skylake 6500 or later)
<b>Memory</b>	4 GB or more
<b>Network function</b>	100BASE-T/TX or 1000BASE-T, RJ-45 connector
<b>Image display</b>	Resolution: 1920 x 1080 pixels or more Color generation: True Color 24-bit or more
<b>Supported operating systems and web browsers</b>	For Windows: Microsoft® Windows® 7,10 Windows® Internet Explorer® 11 64-bit/32-bit  Microsoft Edge Google Chrome
	For Mac: macOS 10.14 macOS 10.13 macOS 10.12 OS X 10.11  Safari Google Chrome
<b>Other</b>	Graphics card support hardware acceleration (for decode H.264/H.265/JPEG streaming) Adobe® Reader® (for viewing the operating instructions available on the website)

### IMPORTANT

Failure to provide the required personal computer environment may slow down the delineation of the images on the screen, make it impossible for the web browser to work and cause other kinds of problems.

### [Note]

- Depending on the software version of the unit, an update may be necessary.
- For the latest information on compatible operating systems, and web browsers, visit the support site at the website: <https://pro-av.panasonic.net/>



# Network security

As you will use the unit connected to a network, your attention is called to the following security risks.

- 1) Leakage or theft of information through the unit
- 2) Use of the unit for illegal operations by persons with malicious intent
- 3) Interference with or stoppage of the unit by persons with malicious intent

It is your responsibility to take precautions such as those described below to protect yourself against the above network security risks.

- Enable user authentication from web screen.
- Use the unit in a network secured by a firewall, etc.
- If the unit is connected to a network that includes personal computers, make sure that the system is not infected. By computer viruses or other malicious entities (using a regularly updated antivirus program, anti-spyware program, etc.)."
- Protect your network against unauthorized access by restricting users to those who log in with an authorized user name and password.
- After accessing the unit as an administrator, be sure to close all web browsers.
- Change the administrator password periodically.
- To avoid passwords that can be guessed easily by third parties, set a password of at least 8 characters in length, including at least 3 different types of characters, such as upper case, lower case, numbers, and symbols
- Restrict access to the unit by authenticating the users, for example, to prevent setting information stored on the unit from leaking over the network.
- Do not install the camera in locations where the camera or the cables can be destroyed or damaged by persons with malicious intent.
- Avoid connections that use public lines.

[Note]

- **Notes on user authentication**

User authentication on the unit can be performed via digest authentication or basic authentication. If basic authentication is used without the use of a dedicated authentication device, password leaks may occur. We recommend using digest authentication.

- **Usage restrictions**

Use of the same segment is recommended for the network in which the unit and personal computer are connected. If the equipment uses connections with different segments, events based on the settings inherent to the network equipment, for instance, may occur so check this thoroughly prior to operation.

# Characteristics

## Overview

This 4K camera features single focus, ultra-wide angle 111 ° lens, and uses a 1/2.5" type MOS sensor and supports wider video output in various formats including 4K / 30p output.

A single cable solution with one Ethernet cable is enabled, and compatibility with remote cameras is enhanced by protocol support such as RTMP. Connecting a controller<sup>\*1</sup> enables smooth camera operation by IP control. In addition, it is equipped with a USB camera function that can be easily connected and applied to various applications.

## Characteristics

<p><b>Multi-format support</b> You can switch between the following formats via the menus or a web browser. [4K format] 2160/29.97p, 2160/30p, 2160/25p [HD format] 1080/59.94p, 1080/60p, 1080/50p, 1080/29.97p, 1080/30p, 1080/25p 720/59.94p, 720/60p, 720/50p</p> <p><b>1/2.5" MOS sensor and ultra-wide angle 111 ° fixed focus lens</b> With the ultra-wide-angle (111 ° horizontal) lens, you can capture a wider space video, and you can reproduce clear images for a wide range of applications. Storage of up to 100 positions in the preset memory.</p> <p><b>Single cable solution</b> By supporting PoE power supply, we have realized a single cable solution that enables video signal / control signal / power supply with one Ethernet cable.</p> <p><b>IP image output functions</b> It supports 4K30p output with RTMP (Real-Time Messaging Protocol), which can upload video directly to live distribution service, and it demonstrates high operability in live production use.</p>	<p><b>Affinity with remote camera</b> By supporting PoE power supply and RTMP / RTSP support, the affinity with the remote camera series is further enhanced.</p> <p><b>USB camera</b> It is also possible to use USB camera with easy connection one USB cable by USB power supply from PC.</p> <p><b>Use of easy-to-operate wireless remote control (optional) is possible</b> A wireless remote control capable of operating up to four units can be used. It can easily be used to set the various functions or switch between them while viewing the menu screens.</p> <p><b>Flexible camera layout enabled by simple connection and installation</b> IP control, lightweight body and simple up/down and inverse mechanism result in outstanding DIY (indoor applications only) connectivity and installation ease. Remember that this unit is designed to be used indoors only: It cannot be used in outdoor.</p> <p><b>Easy connections and settings courtesy of IP controller<sup>*1</sup></b> Up to two hundred units can be operated by IP connection from a Panasonic controller (AW-RP60). (The maximum length of the LAN cables is 100 meters (328 ft).) Network connection with AW-RP60 requires setup of an initial account. When an initial account is not setup, AW-RP60 can detect but cannot control this unit.</p> <p><b>Energy-savings achieved by the compact main unit design</b> The main unit is lightweight and compact at less than 0.5 kg and low 5 W energy consumption means multiple cameras can be connected easily.</p>
---	---

\*1: When using the controller, please upgrade the firmware version of this unit to Ver. 1.32 or later.

# Accessories

---

Check that the following accessories are present and accounted for.

After removing the product from its container, dispose of packing materials in an appropriate manner.

**USB Cable**

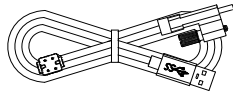

**Drop-prevention wire**



**Mount kit**



**L-Mount kit**

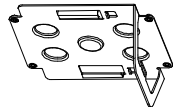

**Tripod screw**

(I-head type, 1/4 x 20 UNC)



**M4 screw**

10 mm length (4 screws)



**M4 screw**

5 mm length(4 screws)

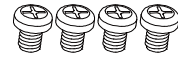

## Optional Accessories

- Wireless remote control AW-RM50G (Size "AA" dry battery x 2, obtained separately)
- Direct ceiling mount bracket WV-Q105A"

[Note] For details on optional accessories, refer to the catalog or consult your local dealer.

# Operating Precautions

---

## ■ Shoot under the proper lighting conditions.

To produce pictures with eye-pleasing colors, shoot under the proper lighting conditions. The pictures may not appear with their proper colors when shooting under fluorescent lights. Select the proper lighting as required.

## ■ To ensure a stable performance in the long term

Using the unit for prolonged periods in locations where the temperature and humidity levels are high will cause its parts to deteriorate, resulting in a reduction of its service life. (Recommended temperature: Max. 35 °C (95 °F))

Ensure that a cooling unit or heating unit will not blow any air directly toward the installation location.

## ■ Do not point the camera at strong lights.

When parts of the MOS sensor are exposed to spotlights or other strong lights, blooming (a phenomenon where the edges of strong lights become blurred) may occur.

## ■ What happens with high-brightness subjects

Flare may occur if an extremely bright light source is pointed at the lens. In a case like this, change the angle or take some other remedial action.

## ■ Concerning the Image distortion.

Due to the characteristics of the lens, the edge of the image is distorted.

## ■ Color bars

Color bars are used to adjust the color phase, and the widths and positions of these bars may differ from other models.

## ■ Concerning PoE power supply

The unit complies with the IEEE802.3af standard. Use a compatible Ethernet hub and PoE injector to use a PoE power supply.

## ■ Turn off the power before connecting or disconnecting the cables.

Always be sure to turn off the power before connecting or disconnecting the cables.

## ■ When using the automatic functions

In the [Scene] such as the camera menu, the initial settings on some items has been set to auto, making it impossible for these items to be operated manually. To operate them manually, switch from the auto settings to the manual settings as required. When using the ATW (auto tracking white adjustment) function under fluorescent lights, the white balance may vary.

## ■ Operating temperature range

Avoid using the unit in cold locations where the temperature drops below 0 °C (32 °F) or hot locations where the temperature rises above 40 °C (104 °F) since these temperatures downgrade the picture quality and adversely affect the internal parts.

Also, it may take a few minutes to stabilize the image when used in low temperatures. We recommend that you turn on this unit before use.

## ■ Concerning the HDMI interface standard

This unit has been certified as HDMI-compatible, but on rare occasions images may not be displayed depending on the HDMI device which has been connected to the unit.

## ■ When the unit is not in use

Turn off the unit's power when it is not in use. When the unit is no longer going to be used, do not leave it lying around, but be absolutely sure to dispose of it properly.

## ■ Do not touch the optical system.

Under no circumstances must they be touched. In the unlikely event that they have become dusty, remove the dust by using a camera blower or by wiping them gently with a lens cleaning paper.

## ■ Do not point the camera directly at the sun or a laser beam.

Taking images of the sun, laser beams, or other brightly lit subjects for prolonged periods of time may damage the MOS sensor.

## ■ Personal computer used

If the same image is displayed for a prolonged period on a PC monitor, the monitor may be damaged. Use of a screen saver is recommended.

## ■ Concerning the IP address setting

Do not run the Easy IP Setup Software on a multiple number of personal computers for a single camera and set the IP address at the same time. Otherwise, you will be unable to complete the proper procedure and set the IP address correctly.

■ **H.264/H.265 patent pool licensing**

This product is licensed based on the AVC Patent Portfolio License, and the license does not extend beyond uses by users, who engage in the acts described below, for their own personal and non-profit applications.

- (i) Recoding of image information in compliance with the AVC standard (hereafter, "AVC videos")
- (ii) Playing of AVC videos recorded by consumers engaging in personal activities or AVC videos acquired from licensed providers

For details, visit MPEG LA, LLC website (<http://www.mpegla.com>).

■ **Handle the unit carefully.**

Do not drop the unit or subject it to strong impact or vibration. Doing so may cause the unit to malfunction.

■ **Keep the unit away from water**

Avoid all direct contact with water. Otherwise, problems may occur.

■ **Disposal of the unit**

When the unit has reached the end of its service life and is to be disposed of, asks a qualified contractor to dispose of the unit properly in order to protect the environment.

■ **Maintenance**

Turn off the unit's power before proceeding with maintenance. Otherwise, you may injure yourself. Wipe the surfaces using a soft dry cloth. Avoid all contact with benzene, paint thinners and other volatile substances, and avoid using these substances. Otherwise, the casing may become discolored.

■ **Use the unit in an environment with minimal moisture and dust.**

Avoid using the unit in an environment with high concentration of moisture or dust since these conditions will damage the internal parts.

■ **Information on software used with this product**

This product incorporates the following software:

- (1) the software developed independently by or for Panasonic Connect Co., Ltd.,
- (2) the software owned by third party and licensed to Panasonic Connect Co., Ltd.,
- (3) the software licensed under the GNU General Public License, Version 2.0 (GPL V2.0),
- (4) the software licensed under the GNU LESSER General Public License, Version 2.1 (LGPL V2.1), and/or
- (5) open source software other than the software licensed under the GPL V2.0 and/or LGPL V2.1.

The software categorized as (3) - (5) are distributed in the hope that it will be useful, but WITHOUT ANY WARRANTY, without even the implied warranty of MERCHANTABILITY or FITNESS FOR A PARTICULAR PURPOSE. Please refer to the detailed terms and conditions that can be downloaded from the web screen

At least three (3) years from delivery of this product, Panasonic will give to any third party who contacts us at the contact information provided below, for a charge no more than our cost of physically performing source code distribution, a complete machine-readable copy of the corresponding source code covered under GPL V2.0, LGPL V2.1 or the other licenses with the obligation to do so, as well as the respective copyright notice thereof.

<https://pro-av.panasonic.net>

However, do not contact Panasonic for questions regarding obtained source codes.

# Names and Functions of Parts

---

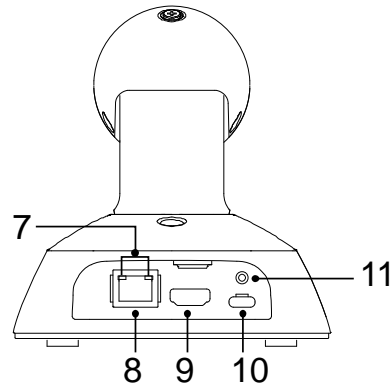
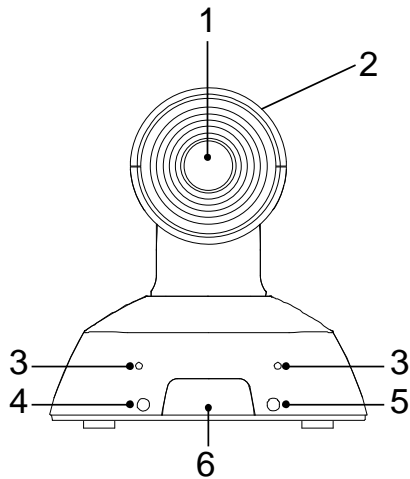

1. **Lens**
2. **Camera head**
3. **Internal microphone**
4. **Power status indicator**
  - Orange light: Standby mode
  - Green light: The unit is turned on
  - Flashing green light: The unit is receiving a wireless remote control signal with a matching remote control ID
  - Flashing orange light(1Hz): The unit is receiving a wireless remote control signal with a different remote control ID.
  - High speed (5Hz) flashing orange light: When a signal from the wireless remote control is received while the wireless control is set to "Disable" from the web screen menu.
  - Flash red light: Firmware updating
  - Red light: Firmware update failure or other abnormal.
5. **Tally status indicator**
6. **Wireless remote control signal light-sensing area**

7. **LAN indicator(LINK/ACT)**

Lights up when data is transmitted/received via LAN.
8. **LAN connector**

Use a category 5e or above LAN cable with a maximum length of 100 m (328 ft.)
9. **HDMI terminal**
10. **USB terminal** [🔌]

Power can be supplied from any device that complies with USB battery charging standards. Always use a USB cable is included in accessories.
11. **Screw hole for USB cable**

## Names and Functions of Parts (continued)

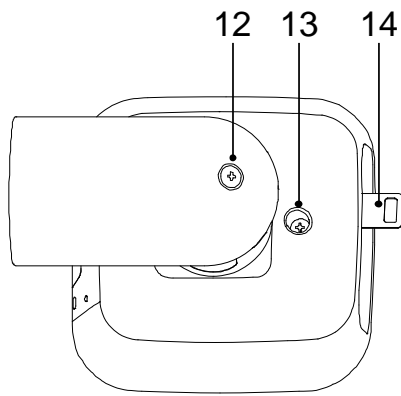

- 12. Perpendicular fixing screw
- 13. Horizontal fixing screw
- 14. Drop-prevention wire mounting portion

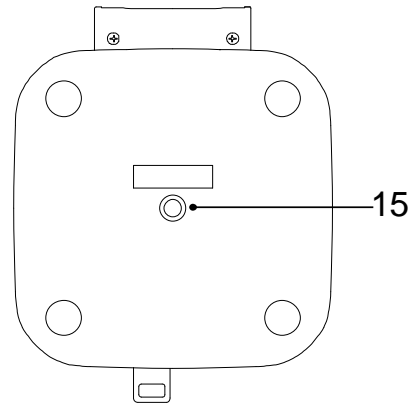

- 15. Mount hole  
[Screw: I-head type, 1/4 x 20 UNC  
Clamping torque: 1.47 N · m(15kgf · cm)]

## Tilting the Camera Up and Down

When the perpendicular fixing screw (A) is loosened, the camera can be tilted approximately 25 °up or down.

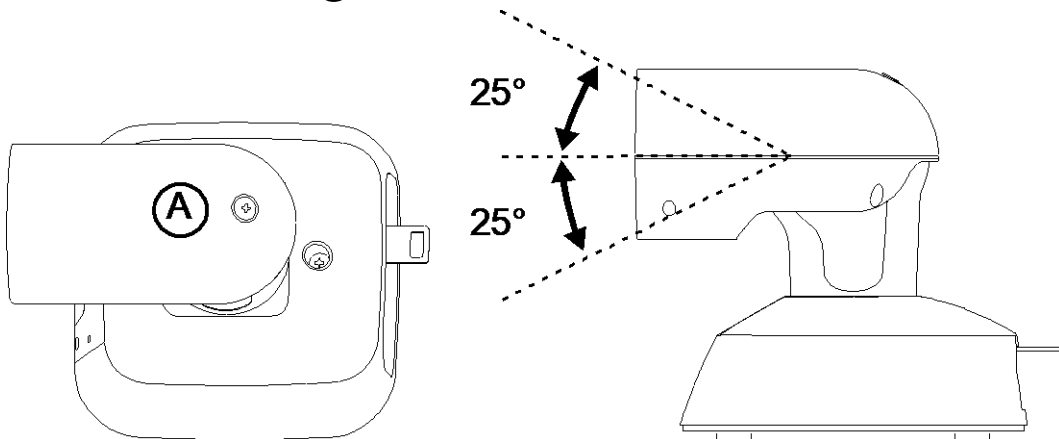

After adjusting the position of the camera, firmly tighten the screw to fix the camera in position.

## Panning the Camera Right and Left

When the horizontal fixing screw (B) is loosened, the camera can be pan 110 ° in the horizontal right or left.

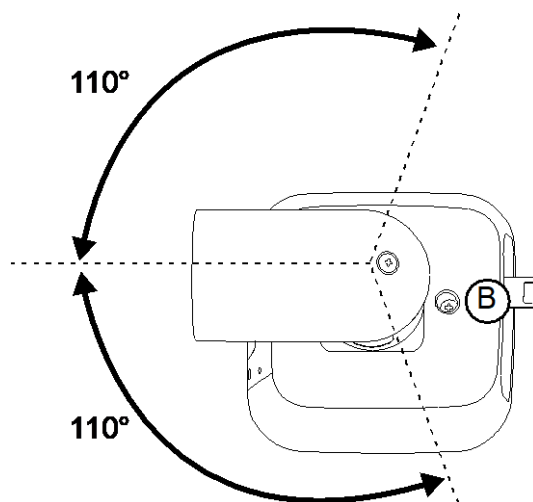

After adjusting the position of the camera, firmly tighten the screw to fix the camera in position.

# Wireless Remote Control(optional accessory)

You can operate the unit with the optional wireless remote control (AW-RM50G).

**Consult your dealer concerning the purchase of a wireless remote control.**

Buttons used for operating this unit are described.

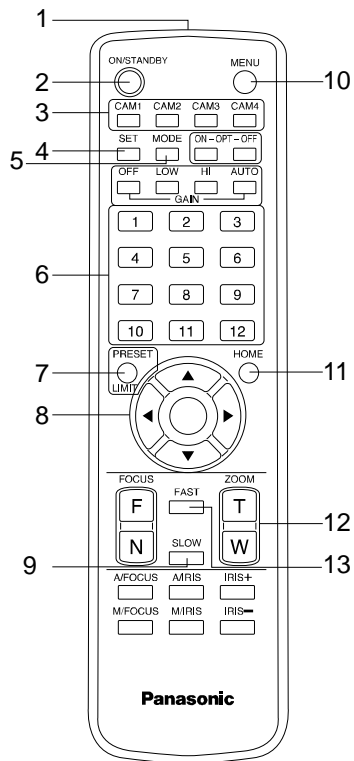

<b>1</b>	<b>Signal transmission window</b>
<b>2</b>	<b>ON/STANDBY button</b> Each time this is pressed for 2 seconds, operation switches between turning on the unit's power and establishing the standby status.
<b>3</b>	<b>CAM1 to CAM4 buttons</b> Selects a camera to be operated. Once a button has been selected, the unit corresponding to the selected button can be operated.
<b>4</b>	<b>SET button</b> If this button is pressed when the [AWB A] memory or [AWB B] memory has been selected for the white balance adjustment, the white balance is automatically adjusted and registered in the selected memory.
<b>5</b>	<b>MODE button</b> Each time you press the button, the signal switches between the color bar signal output and the camera image output.
<b>6</b>	<b>1 to 12 buttons</b> These are used to call the information on the picture's directions and other settings, which have been registered in the units preset memories No.1 to No.12, and reproduce those settings. Setting in preset memories No.13 and above cannot be called from the wireless remote control
<b>7</b>	<b>PRESET button</b> Press this button and any of the buttons from 1 to 12 simultaneously to register a preset memory.
<b>8</b>	<b>Pan-tilt buttons and menu operation buttons</b> (1)These are used to change the picture's direction. The picture is tilted in the up/down direction using the [▲] and [▼] buttons and panned in the left/right direction using the [◀] and [▶] buttons. The [○] button does not work during tilting and panning. When the [▲] or [▼] and [◀] or [▶] buttons are pressed at the same time, the unit moves diagonally. (2) The buttons are used for menu operations when the unit displays the camera menus. Use the [▲] and [▼] buttons to select the menu items. When a selected item has a sub-menu, the sub-menu will be displayed by pressing the [○] or [▶] button. When the [○] or [▶] button is pressed on the setting menu at the bottom hierarchical level, the new setting is entered.
<b>9</b>	<b>SLOW button</b> Changes the pan/tilt or zoom speed to low speed.
<b>10</b>	<b>MENU button</b> Press and hold for 2 seconds to display the camera menu of the unit.



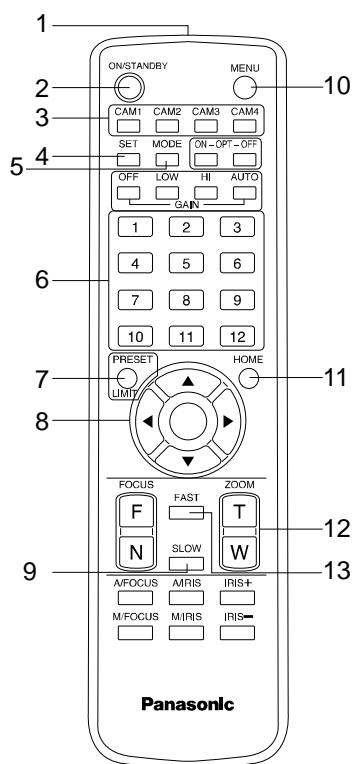

11	<b>HOME button</b> If you press and hold the button for 2 seconds, the zoom level of the unit is changed to x1.
12	<b>ZOOM button</b> These are used to adjust the digital zoom. The zoom is adjusted in the wide-angle using the [W] button and in the telephoto using the [T] button
13	<b>FAST button</b> Changes the pan/tilt or zoom speed to high speed.

Check out the following points before using the wireless remote control.

- **Point the wireless remote control at the unit's wireless remote control signal light-sensing area (front side), and operate it within a range of 10 meters (32.8 ft.) from the area.**
- **Refer to <Layout of wireless remote control signal light-sensing areas> on the below.**
- **The signal sensing distance is reduced if the angle at which the wireless remote control signals are sensed is increased.**  
 The light-sensing sensitivity is reduced to about one-half when the wireless remote control is pointed at an angle of 40 degrees from each position in front of a wireless remote control signal light-sensing area (front panel or back panel).  
 If the remote control is operated from the behind the unit, it may be either difficult or impossible to perform the desired operations.
- **If the unit is installed near fluorescent lights, plasma monitors or other such products or if the unit is exposed to sunlight, the effects of the light may make it impossible for the unit to be operated using the wireless remote control.**  
 Be sure to follow the steps below for installation and use.
  - ✓ Take steps to ensure that the wireless remote control signal light-sensing area will not be exposed to the light from fluorescent lights, plasma monitors or other such products or from the sun.
  - ✓ Install the unit away from fluorescent lights, plasma monitors and other such products.
- **For about 10 minutes even after the batteries have been removed from the wireless remote control, the selection of the operation to be performed (the <CAM1>, <CAM2>, <CAM3> or <CAM4> button which was pressed last) will remain stored in the memory.**  
 When a longer period of time elapses, however, the selection is reset to the status established when the <CAM1> button was pressed.
- **The unit's status indicator LED blinks green when a signal matched by the wireless remote control ID has been received, and it blinks orange when a signal that is not matched by the wireless remote control ID has been received.**
- **When the wireless control in the web screen menu is set to "Off", you cannot operate with the wireless remote control. The power status indicator flashes orange rapidly (5Hz). When operating with the wireless remote control, set the wireless control in the web screen menu to "On".**

**<Layout of wireless remote control signal light-sensing areas>**

[Note] The arrows in the figure below show the light-sensing directions in which the wireless remote control signals travel.

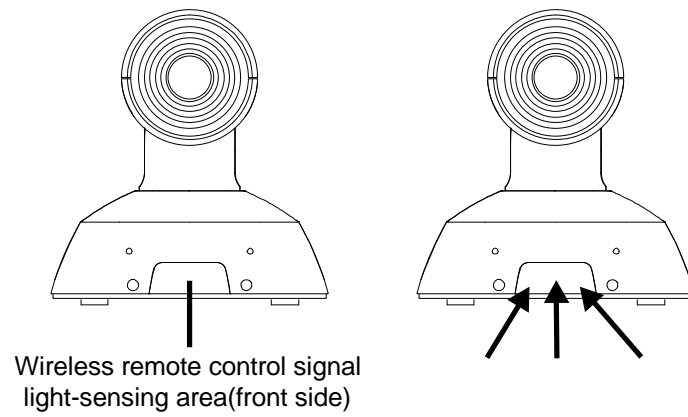

# Network Settings

## Use the Easy IP setup Software to Establish the Unit's Settings

The settings related to the unit's network can be established using the Easy IP Setup Software.

You can obtain Easy IP Setup Software (EasyIPSetup.exe) by downloading it from the following website.

<https://pro-av.panasonic.net/>

To establish the settings for a multiple number of units, the settings must be selected for each camera involved.

If the settings cannot be established using the Easy IP Setup Software, select the settings separately for the unit and personal computer on the Network setup screen [Network] of the setting menu.

[Note]

- If, after the network settings have been established, another device in the same network has the same IP address, the network operations will not be performed properly.
- Set the IP address in such a way that it does not duplicate an existing IP address.
- Do not establish network settings from a multiple number of Easy IP Setup Software programs at the same time for a single camera. Similarly, do not perform the "Auto IP setting" operation of the AW-RP60 remote camera controller at the same time.
- The IP address settings may no longer be recognized as a result.
- To enhance the security of the Easy IP Setup Software, it will not be possible to make network settings for the target camera once about 20 minutes or more have elapsed after turning the power of the camera on. (When the [Easy IP Setup accommodate period] setting is [20min] )
- The Easy IP Setup Software cannot be used from a different subnet via a router.
- Use Easy IP Setup Software ver. 4.25R00 or newer.

1. Start the Easy IP Setup Software.
2. Click the [Search] button.

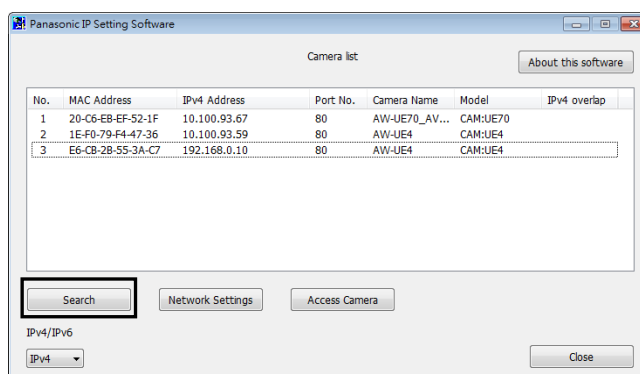

3. Click the MAC address/IPv4 address of the camera to be set, and click the [Network Settings] button.

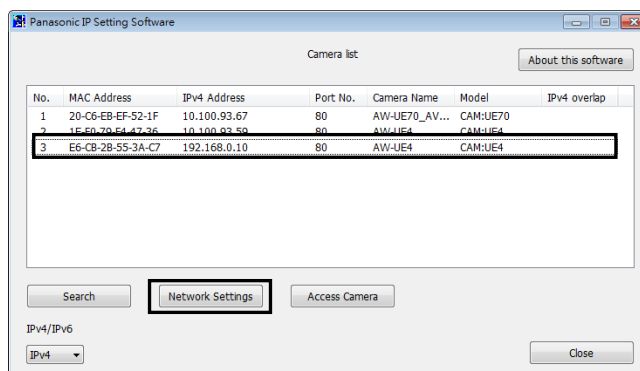

[Note]

- When a DHCP server is being used, the IP address allocated to the unit can be checked by clicking the [Search] button of the Easy IP Setup Software.
- If the same IP address is used for any additional cameras, the numbers of the additional cameras will be displayed in the [IPv4 overlap] column of the cameras concerned.
- When the [Access Camera] button is clicked, the live screen of the selected camera is displayed.

- This unit supports an IPv4/IPv6 switching function.
4. Input the network items, and click the [Save] button.

The screenshot shows a 'Network Settings' window with the following configuration:

- Network Settings:  StaticIP,  DHCP
- Port No.: 80
- IPv4 Address: 10 . 100 . 93 . 78
- Subnet Mask: 255 . 255 . 255 . 0
- Default Gateway: 10 . 100 . 93 . 254
- DNS:  Auto,  Manual
- Primary DNS: 0 . 0 . 0 . 0
- Secondary DNS: 0 . 0 . 0 . 0
- Wait for camera restarting.
- Buttons: Save, Back

[Note]

- When a DHCP server is being used, [DNS] of the Easy IP Setup Software can be set to [Auto].
- After the [Save] button is clicked, it takes about 1 minute for the settings in the unit to be completed. If the USB terminal power supply or LAN cable is disconnected before the settings are completed, the settings will be canceled. In this case, repeat the steps to establish the settings.
- When a firewall (including software) has been introduced, enable access to all the UDP ports.

# Setting the Initial Account

## 1. Set the initial account.

In the initial state, the initial account setting screen is displayed when the web screen is displayed. Set a user name and password.

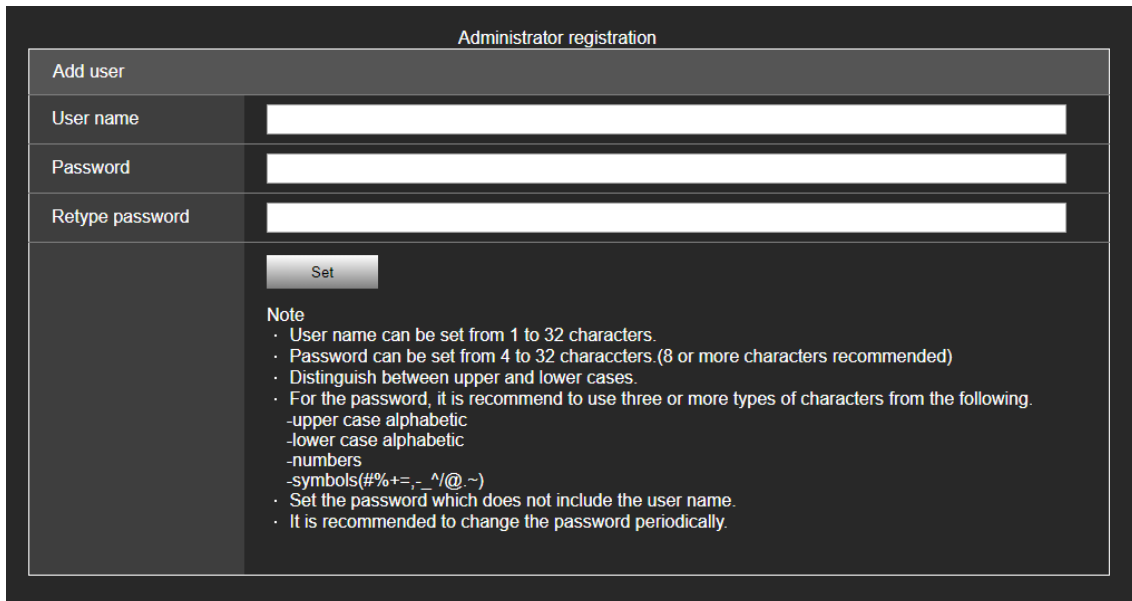

The image shows a registration form titled "Administrator registration". It has a header "Add user" and three input fields: "User name", "Password", and "Retype password". Below the fields is a "Set" button. A "Note" section provides password requirements: 1-32 characters, 4-32 characters (8+ recommended), mixed case, numbers, and symbols (#%+=, -\_^/@.~). It also advises to avoid the user name and to change passwords periodically.

[Note]

- The usable symbols for user name is following (# % + = , - \_ ^ / @ . ~)
- Do not set character strings that can be easily guessed by third parties.
- Change the password at regular intervals.
- The password must use at least 3 of the following 4 character types and be 8 characters or longer.
  - Alphabet upper cases
  - Alphabet lower cases
  - Numerals
  - Symbols (# % + = , - \_ ^ / @ . ~ )
- When a password is set that does not adhere to the above policy, take responsibility for use of the device with due consideration for the security risks in the installation environment, etc.
- A warning is displayed if the set password goes against the recommended setting policy. When changing the password, click the [Back] button and set the password again.
- When continuing with the setting with full understanding of the security risks, click [Continue] to complete the setting.
- If you forget the account information that was set, consult your local dealer.

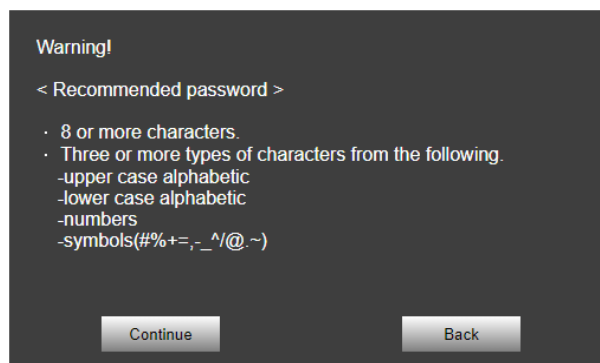

A warning dialog box titled "Warning!" with the text "< Recommended password >". It lists the same password requirements as the registration form: 8+ characters, mixed case, numbers, and symbols (#%+=, -\_^/@.~). At the bottom are "Continue" and "Back" buttons.

## 2. Completing registration of the initial account

After completing registration of the initial account, the live screen [Live] is automatically displayed after a few seconds. This completes the process of registering the initial account.

# Basic Shooting Operation

---

With the basic operations, it is assumed that the white balance will be adjusted automatically (as per the factory settings).

1. Make sure the subject brightness is in the appropriate level.
2. Make sure the unit and all devices are well connected and power on.
3. Press one of the **[CAM1]** to **[CAM4]** buttons on the wireless remote control to select the unit if using the wireless remote control. Even when using only one unit, it must still be selected from the wireless remote control or controller.
4. Select the scene (shooting) mode.  
Select one of the three (**Full Auto**, **Shutter Priority**, and **Manual**) scene modes, each of which corresponds to a set of circumstances in which the subject will be shot.  
Select the mode that satisfies the shooting conditions and suits your preferences.  
When continuing to shoot in the same circumstances, there is no need to select another mode.
5. Start shooting.  
[Note]  
Due to the characteristics of the lens, the edge of the image is distorted.  
When using the controller, please upgrade the firmware version of this unit to Ver. 1.32 or later.

# **Power on and Power Off the Camera Unit**

## **Power on the Camera Unit**

*When performing the operations using the wireless remote control.*

**1. Set all the power switches of the units and devices connected in the system to ON.**

When the power is supplied, the status display lamp lights orange and it takes about 30 seconds to complete the initial setting. After the initial setting is completed, it switches to green and the power turns on.

[Note]

- It takes about 30 seconds per unit for the initial settings operation to be completed. During this period, the unit cannot be operated.
- The unit stores its STANDBY / POWER ON mode status in the memory.
- If the power supply is cut off while the operation is in POWER ON mode, the operation will transfer to the POWER ON mode the next time power is supplied.
- When transferring to the STANDBY mode
  - Status indicator LED: Orange
- When transferring to the POWER ON mode
  - Status indicator LED: Green (after the initial setting operation is completed)
  - The pan/tilt position is moved to the position which was stored in the memory when the transition to the STANDBY mode was made.
- POWER ON preset
  - The pan/tilt position return to the place just before entering STANDBY mode when returning from STANDBY mode to POWER ON mode.
- If the power is turned off without transferring to the STANDBY mode, the pan/tilt unit position will not be stored in the memory or reflected in the POWER ON preset. The previous POWER ON preset will be applied.

*When performing the operations using the controller (AW-RP60).*

For details, refer to the operating instructions for the controller.

## **Power off the Camera Unit**

*When performing the operations using the wireless remote control*

- 1. Press one of the [CAM1] to [CAM4] buttons on the wireless remote control to select the unit.**
- 2. Press the [ON/STANDBY] button on the wireless remote control for 2 seconds.**  
The unit enters STANDBY mode.
- 3. The unit's status display lamp now lights up orange.**
- 4. If a multiple number of units are used, repeat steps 1 and 2 as required.**
- 5. Set all the power switches of the units and devices connected in the system to OFF.**

*When performing the operations using the controller (AW-RP60).*

For details, refer to the operating instructions for the controller.

# Priority Mode

Changing the priority mode enables the unit to perform operation for various applications.

- **HDMI(4K):** 4K video is output to an external monitor connected via an HDMI cable.
- **IP(4K):** Enables IP image transmission. IP image transmission of 4K images uses the H.264/H.265 video coding format. This unit cannot display H.264/H.265 format images on the Live screen. To display H.264/H.265 images, use an external device or external software that supports H.264/H.265 images.
- **USB(4K):** Enables the unit to be used as a 4K Web camera. The camera can also be controlled from a personal computer.
- **HDMI/USB:** HD format video is output to an external monitor connected via an HDMI cable. Enables the unit to be used as a Web camera. The camera can also be controlled from a personal computer. (This mode can be set only during PoE power supply.)
- **USB:** Enables the unit to be used as a Web camera. The camera can also be controlled from a personal computer. (This mode can be set only when power is supplied from a PC.)
- **USB (Video Conference):** Enables the unit to be used as a Web camera. The camera can also be controlled from a personal computer. (This mode can be set only when power is supplied from a PC. Under USB (Video Conference) mode, in order to minimize the delay of UVC output, UAC output, HDMI output, and Web live view are disabled.)
- **HDMI:** HD format video is output to an external monitor connected via an HDMI cable. (This mode can be set only when power is supplied from the AC adapter.)
- **IP:** Enables IP image transmission. The IP transmission of H.264/H.265 images is also supported. This unit cannot display H.264/H.265 format images on the Live screen. To display H.264/H.265 images, use an external device or external software that supports H.264/H.265 images.

Functions that can be and functions that cannot be controlled simultaneously.

Power Supply	Priority Mode	Output terminal			
		HDMI	USB	LAN	
				RTSP/RTMP	Web(HTTP)
PoE	HDMI (4K)	[50Hz] 2160/25p [59.94Hz] 2160/29.97p [60Hz] 2160/30p	—	—	MJPEG : [50Hz] 720/10fps · 360/25fps [59.94Hz/60Hz] 720/10fps · 360/30fps
	USB (4K)	—	H264: [50Hz] 2160/25fps · 10fps · 5fps [59.94Hz/60Hz] 2160/30fps · 15fps · 5fps MJPEG: 2160/5fps	—	MJPEG : [50Hz] 720/10fps · 360/25fps [59.94Hz/60Hz] 720/10fps · 360/30fps
	IP (4K)	—	—	H264 or H.265: [50Hz] 2160/25fps · 10fps · 5fps [59.94Hz/60Hz] 2160/30fps · 15fps · 5fps	MJPEG : [50Hz] 720/10fps · 360/25fps [59.94Hz/60Hz] 720/10fps · 360/30fps



Power Supply	Priority Mode	Output terminal			
		HDMI	USB	LAN	
				RTSP/RTMP	Web(HTTP)
PoE	HDMI/USB	[50Hz] 1080/50p、1080/25p、 720/50p [59.94Hz] 1080/59.94p、 1080/29.97p、 720/59.94p [60Hz] 1080/60p、1080/30p、 720/60p	H264: [50Hz] 1080/50fps、25fps、10fps、 5fps、720/50fps、25fps、 10fps、5fps、360/50fps、 25fps、10fps、5fps [59.94Hz/60Hz] 1080/60fps、30fps、15fps、 5fps、720/60fps、30fps、 15fps、5fps、360/60fps、 30fps、15fps、5fps MJPEG: [50Hz] 1080/25fps、10fps、5fps、 720/25fps、10fps、5fps、 360/25fps、10fps、5fps [59.94Hz/60Hz] 1080/30fps、15fps、5fps、 720/30fps、15fps、5fps、 360/30fps、15fps、5fps YUV: [50Hz] 360/10fps [59.94Hz/60Hz] 360/15fps	—	MJPEG : [50Hz] 720/10fps、360/25fps [59.94Hz/60Hz] 720/10fps、360/30fps
	IP	[50Hz] 1080/25p [59.94Hz] 1080/29.97p [60Hz] 1080/30p	—	H264or H.265: [50Hz] 1080/50fps、25fps、10fps、 5fps、720/50fps、25fps、 10fps、5fps、360/50fps、 25fps、10fps、5fps [59.94Hz/60Hz] 1080/60fps、30fps、15fps、 5fps、720/60fps、30fps、 15fps、5fps、360/60fps、 30fps、15fps、5fps	MJPEG : [50Hz] 720/10fps、360/25fps [59.94Hz/60Hz] 720/10fps、360/30fps
	USB (Video Conference)	—	MJPEG: [50Hz] 1080/25fps、10fps、5fps、 720/25fps、10fps、5fps、 360/25fps、10fps、5fps [59.94Hz/60Hz] 1080/30fps、15fps、5fps、 720/30fps、15fps、5fps、 360/30fps、15fps、5fps YUV: [50Hz] 360/25fps [59.94Hz/60Hz] 360/30fps	—	—

Power Supply	Priority Mode	Output terminal			
		HDMI	USB	LAN	
				RTSP/RTMP	Web(HTTP)
USB (PC Power)	USB (4K)	—	H264: [50Hz] 2160/25fps · 10fps · 5fps [59.94Hz/60Hz] 2160/30fps · 15fps · 5fps MJPEG: 2160/5fps	—	MJPEG : [50Hz] 720/10fps · 360/25fps [59.94Hz/60Hz] 720/10fps · 360/30fps
	USB	—	H264: [50Hz] 1080/50fps · 25fps · 10fps · 5fps · 720/50fps · 25fps · 10fps · 5fps · 360/50fps · 25fps · 10fps · 5fps [59.94Hz/60Hz] 1080/60fps · 30fps · 15fps · 5fps · 720/60fps · 30fps · 15fps · 5fps · 360/60fps · 30fps · 15fps · 5fps MJPEG: [50Hz] 1080/25fps · 10fps · 5fps · 720/25fps · 10fps · 5fps · 360/25fps · 10fps · 5fps [59.94Hz/60Hz] 1080/30fps · 15fps · 5fps · 720/30fps · 15fps · 5fps · 360/30fps · 15fps · 5fps YUV: [50Hz] 360/10fps [59.94Hz/60Hz] 360/15fps	—	MJPEG : [50Hz] 720/10fps · 360/25fps [59.94Hz/60Hz] 720/10fps · 360/30fps
	USB (Video Conference)	—	MJPEG: [50Hz] 1080/25fps · 10fps · 5fps · 720/25fps · 10fps · 5fps · 360/25fps · 10fps · 5fps [59.94Hz/60Hz] 1080/30fps · 15fps · 5fps · 720/30fps · 15fps · 5fps · 360/30fps · 15fps · 5fps YUV: [50Hz] 360/25fps [59.94Hz/60Hz] 360/30fps	—	—

Power Supply	Priority Mode	Output terminal			
		HDMI	USB	LAN	
				RTSP/RTMP	Web(HTTP)
USB (AC adapter) 5 V/1 A or more	HDMI (4K)	[50Hz] 2160/25p [59.94Hz] 2160/29.97p [60Hz] 2160/30p	—	—	MJPEG : [50Hz] 720/10fps、360/25fps [59.94Hz/60Hz] 720/10fps、360/30fps
	IP (4K)	—	—	H264 or H.265: [50Hz] 2160/25fps、10fps、5fps [59.94Hz/60Hz] 2160/30fps、15fps、5fps	MJPEG : [50Hz] 720/10fps、360/25fps [59.94Hz/60Hz] 720/10fps、360/30fps
	HDMI	[50Hz] 1080/50p <sup>*1</sup> 、 1080/25p、720/50p [59.94Hz] 1080/59.94p <sup>*1</sup> 、 1080/29.97p、 720/59.94p [60Hz] 1080/60p <sup>*1</sup> 、 1080/30p、720/60p	—	—	MJPEG : [50Hz] 720/10fps、360/25fps [59.94Hz/60Hz] 720/10fps、360/30fps
	IP	[50Hz] 1080/25p [59.94Hz] 1080/29.97p [60Hz] 1080/30p	—	H264 or H.265: [50Hz] 1080/50fps、25fps、10fps、 5fps、720/50fps、25fps、 10fps、5fps、360/50fps、 25fps、10fps、5fps [59.94Hz/60Hz] 1080/60fps、30fps、15fps、 5fps、720/60fps、30fps、 15fps、5fps、360/60fps、 30fps、15fps、5fps	MJPEG : [50Hz] 720/10fps、360/25fps [59.94Hz/60Hz] 720/10fps、360/30fps

\*1 : Please upgrade the firmware version of this unit to Ver. 1.32 or above.

# Selecting the Camera Unit

---

*When performing the operations using the wireless remote control*

Press the [CAM1], [CAM2], [CAM3] or [CAM4] button.

The camera unit's status indicator LED blinks green when a signal matched by the remote control ID has been received, and it blinks orange when a signal that is not matched by the remote control ID has been received.

*When performing the operations using the controller (AW-RP60).*

For details, refer to the operating instructions for the controller.

Network connection with AW-RP60 requires setup of an initial account. When an initial account is not setup, AW-RP60 can detect but cannot control this unit.

# Selecting Scene Mode

---

## Scene Mode Type

The unit has three preset scene modes, each of which corresponds to a set of circumstances in which the subject will be shot.

Select the mode that satisfies the shooting conditions and suits your preferences.

The settings can be changed by menu operations.

The results of the white balance and other adjustments are stored in the memory separately by shooting mode. Be absolutely sure to select the shooting mode before making any adjustments.

### ■ Full Auto

User can adjust the picture level, AGC MaxGain, slow shutter, Chroma level, and white balance.

### ■ Shutter Priority

User can adjust the picture level, AGC MaxGain, shutter speed, Chroma level, and white balance.

### ■ Manual

User can adjust the shutter speed, Gain, Chroma level, and white balance.

## How to select the Scene mode

*When performing the operations using the wireless remote control*

- 1 Press the [CAM1], [CAM2], [CAM3] or [CAM4] button to select the unit.
- 2 Press the [MENU] button for 2 seconds.  
The menu is displayed.
- 3 Press the [▲] or [▼] button to bring the highlight to "CAMERA".

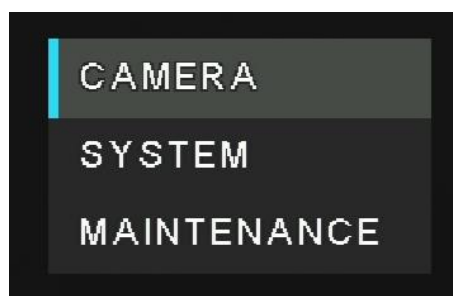

*When performing the operations using the controller (AW-RP60).*

For details, refer to the operating instructions for the controller.

**4 Press the [○] button.**

The "CAMERA" sub-menu is displayed on the monitor.

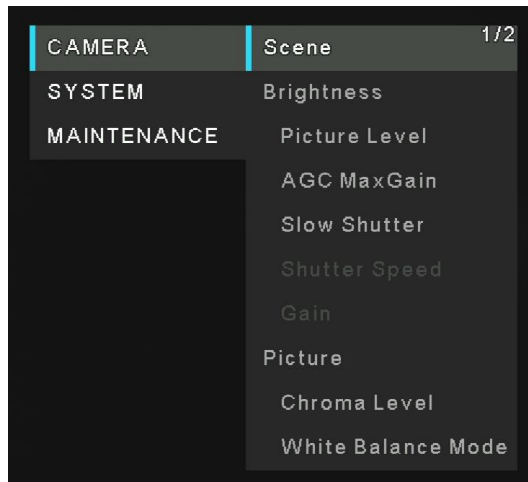

**5 Press the [▲] or [▼] button to bring the highlight to "Scene".**

**6 Press the [○] button.**

**7 Press the [▲] or [▼] button to select the scene mode (Full Auto, Shutter priority, or Manual) and press the [○] button to confirm the selection. The selected scene mode has a mark sign within.**

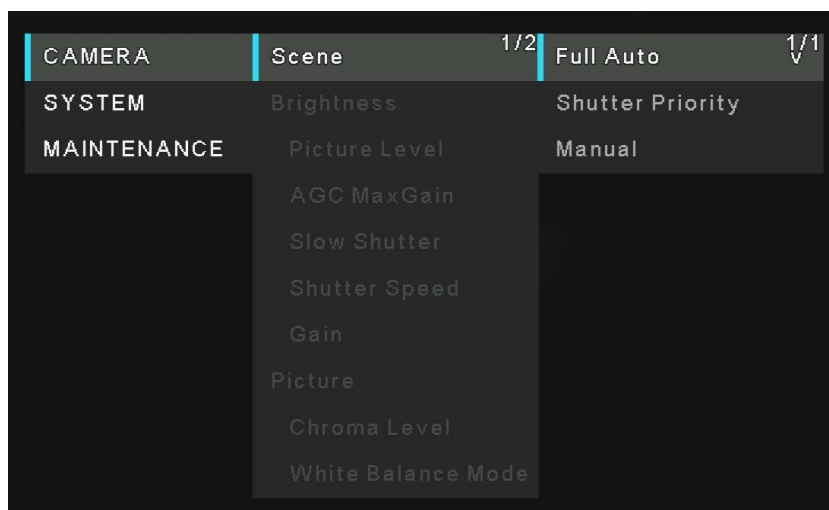

**8 Press [◀] to leave from scene mode menu.**

**9 Press the [MENU] button for 2 seconds to exit from the menu.**

# Operating the Camera unit

When performing the operations using the wireless remote control

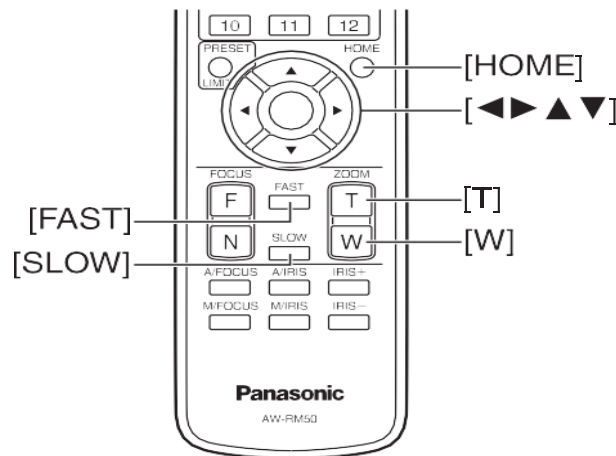

## Control the Picture's Direction (using the wireless remote control)

- Moving the picture toward the left or right (panning): Press the [◀] or [▶] button.
- Moving the picture up or down (tilting): Press the [▲] or [▼] button.
- Moving the picture diagonally: Press the [▲] or [▼] button and [◀] or [▶] button at the same time.
- Returning the picture to the reference position: Press the [HOME] button for 2 seconds.

## Zoom In/Out Function (using the wireless remote control)

- Zooming in (the subject becomes magnified in size): Press the [T] button of [ZOOM].
- Zooming out (the subject becomes reduced in size): Press the [W] button of [ZOOM].

## Switching the Direction or Zoom Speed (using the wireless remote control)

- Changing the direction or zoom at high speed: Press the [FAST] button.
- Changing the direction or zoom at low speed: Press the [SLOW] button.

When performing the operations using the controller (AW-RP60)

## Control the Picture's Direction (using the controller)

- Moving the picture toward the left or right (panning): Tilt the <PAN/TILT> lever toward L or R.
- Moving the picture up or down (tilting): Tilt the <PAN/TILT> lever toward UP or DOWN.
- Moving the picture diagonally: Tilt the <PAN/TILT> lever diagonally.

## Zoom In/Out Function (using the controller)

- Zooming in (the subject becomes magnified in size): Tilt the <ZOOM> lever toward the TELE direction.
- Zooming out (the subject becomes reduced in size): Tilt the <ZOOM> lever toward the WIDE direction.

## Switching the Direction or Zoom Speed (using the controller)

For details, refer to the operating instructions for the controller.

# What to do when Encountering Problems in the Basic Shooting Operations

If the trouble is not resolved by taking the action suggested below, refer to “**Troubleshooting**” section.

## *When performing the operations using the wireless remote control*

- **The unit does not move.**
  - Press the [CAM1], [CAM2], [CAM3] or [CAM4] button to select the unit which is to be operated.
  - If only one unit is being used, it is normally selected using the [CAM1] button.
  - Check that the Wireless ID has been set correctly.
  - If the unit's status display lamp is off or lights up orange, it means that the unit's power is not on.
  - Refer to “**Power on the Camera Unit**” section.
  - If the unit's status display lamp does not blink even when the wireless remote control is operated near the unit's wireless remote control signal light-sensing area, it means that the wireless remote control's batteries have run down. Replace the batteries.
  
- **Multiple color bands (color bars) are displayed.**

Press the [MODE] button to switch to the camera picture.
  
- **The menu screen is displayed.**

Press the [MENU] button for 2 seconds to exit the camera menu.
  
- **Something is wrong with the coloring of the pictures.**

Refer to “**Auto tracking white adjustment (ATW)**” and switch to “**ATW**”.

## *When performing operations from a controller (AW-RP60).*

- **The unit does not move.**
  - Select the unit to be operated by referring to the operating instructions for the controller.
  - if the unit's status display lamp is off or lights up orange, it means that the unit's power is not on. Refer to "Turn the power on", and turn on the power.
  - Check that the account settings for this unit have been set correctly.
  - Network connection with AW-RP60 requires setup of an initial account. When an initial account is not set up, AW-RP60 can detect but cannot control this unit.
  
- **Multiple color bands (color bars) are displayed.**

Switch to the camera image by pressing the <BARS> button.
  
- **Something is wrong with the coloring of the camera pictures.**

Refer to "Auto tracking white adjustment (ATW)", and switch to [ATW].

# Advanced Operations

---

In the following will description more operations and setting of the camera unit.

## Preset Memories

The camera unit enables up to 100 settings for the camera direction (panning and tilting), zoom to be registered in its preset memories, and called. However, the number of settings that can be registered and called depends on the type of wireless remote control or controller that is used for operation.

[Note]

- The recalling of a preset can be performed while the recalling of a preset can be performed while manual operations, such as pan, tilt, zoom.
- Nothing will occur if a preset memory number to which a preset has not been registered is recalled.

### *When performing the operations using the wireless remote control*

Twelve settings (preset No.1 to No.12) can be registered and called using the wireless remote control. The [1] to [12] buttons correspond to the unit's preset memories No.1 to No.12.

#### ■ Registering the settings in the preset memories

- 1 **Display the picture to be shot on the monitor. Operate the pan, tilt or zoom buttons to determine the camera view.**
- 2 **While holding down the [PRESET] button, press the button corresponding to the preset memory number.**  
If a preset memory number with an already registered setting has been selected, the existing setting will be erased and replaced with the new one.

#### ■ Calling the settings of the preset memories

Press the button in which the preset memory setting has been registered.

### *When performing operations from a controller (AW-RP60).*

UP to 100 entries can be registered/recalled.

For details, refer to the operating instructions for the controller.



## Adjust the White Balance

In order for the white to be reproduced accurately, the ratio between the three primary colors (RGB) is adjusted. If the white balance has shifted out of adjustment, not only will the white be reproduced poorly but the color tones of the entire screen will also be degraded.

- This adjustment must be performed when using the unit for the first time or when the unit has not been used for a prolonged period.
- It must be performed when the lighting conditions or brightness has changed.
- Once the white balance values have been adjusted, their setup procedure will be completed simply by selecting them using the menus, web settings or by pressing the buttons on the controller; provided that they are going to be used under the same conditions as the ones established when the values were set. There is no need to set it again.
- Once a new setting is entered, the previous setting will be erased.

[Note] For details, refer to “**Selecting the Scene Mode**” section.

## Automatic Adjustment (AWB: AWB A or AWB B)

*When performing the operations using the wireless remote control*

1. Shoot a white subject (such as a white wall or handkerchief) so that it fills the screen.  
Do not shoot shiny or very bright objects.

Steps 2 through 6 represent the procedure for selecting the “AWB A” or “AWB B” memory. They need not be taken if a selection has already been made.

2. Select Manual as the shooting mode by following the procedure in “Selecting the Scene Mode” section.

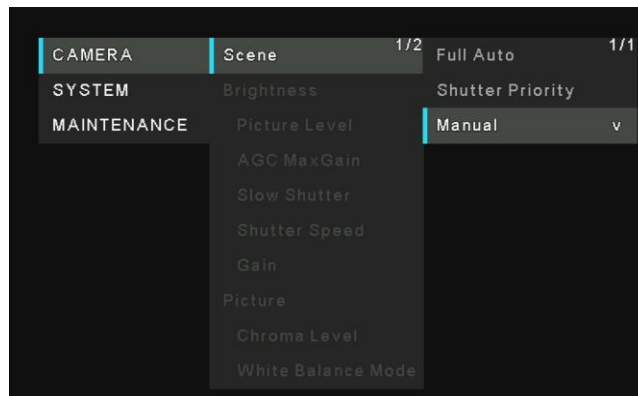

3. Press the [▲] or [▼] button to bring the highlight to “**White Balance Mode**”. Press the [○] button to enter White Balance mode menu.
4. Press the [▲] or [▼] button to change the White Balance Mode to be used to “**AWB A**” or “**AWB B**”, and press the [○] button to confirm the selection. The selected selection will have a mark sign within.

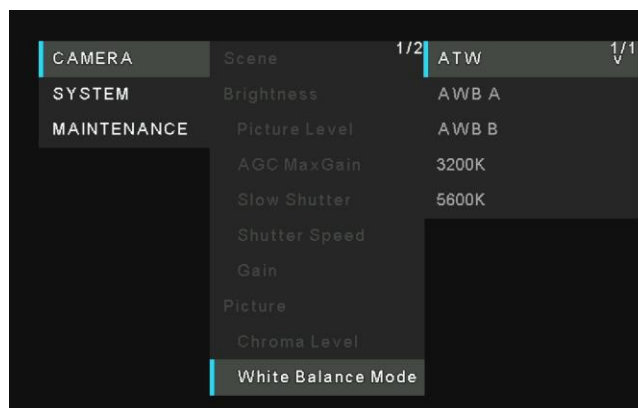

5. Press the [MENU] button for 2 seconds to exit from menu.
6. Press the <SET> button.

The auto white balance adjustment (AWB) is performed, and the white balance setting is entered.

[Note]

- The white balance cannot be adjusted when color bars are displayed. Press the **[MODE]** button to switch to the camera picture.
- White balance may not be correctly set if the lighting of the object is too weak.
- Since the unit has a built-in memory, the set white balance will remain in the memory even if power is turned off. Therefore, it is not necessary to reset the white balance if the color temperature of those objects remains unchanged. However, it must be reset if the color temperature changes, such as when you move from indoors to outside, or vice versa.

***When performing the operations using the controller (AW-RP60).***

For details, refer to the operating instructions for the controller.

## **Auto Tracking White Balance Adjustment (ATW)**

When white balance adjustment is set to “ATW”, the white balance will be corrected automatically, even if the light source or color temperature changes.

This function works when “ATW” is selected instead of “AWB A” or “AWB B” by following the steps for “Automatic adjustment” in “**Automatic Adjustment (AWB: AWB A or AWB B)**” (page 30).

[Note]

- ATW might not function properly when high brightness light (ex. fluorescent lamp) beams into a screen.
- White balance may not be accurately set if there is no white object in the scene being shot.
- The white balance may shift out of adjustment when a different kind of light source such as sunlight or fluorescent lighting applies.

## **3200K and 5600K Presets**

When “3200K” or “5600K” is selected for the white balance, the white balance is set using a color temperature of 3200K (equivalent to halogen light) or 5600K (equivalent to daylight), respectively.

This function works when “3200K” or “5600K” is selected instead of “AWB A” or “AWB B” in the “Automatic adjustment” procedure in “**Automatic Adjustment (AWB: AWB A or AWB B)**”.

# Menu Operation

Menus are displayed on the monitor when the unit's settings are to be selected.

The monitor is connected to the video signal output connector.

The basic camera menu operations involve displaying sub-menus from the main menu items, and selecting settings on the sub-menus.

Some sub-menus have menu items for performing more detailed settings.

The menu operations are conducted using the wireless remote control.

Described below are the basic operations for changing the camera menu item settings using the wireless remote control.

Only the steps taken using the wireless remote control will be described here for the operations conducted to select and set the items.

## Operations Table

Menu operation	Wireless remote control
Selecting the unit to be operated	Press the [CAM1], [CAM2], [CAM3] or [CAM4] button.
Displaying the main Menu	Press the [MENU] button for 2 seconds.
Selecting the items	Press the [▲] or [▼] ([◀] or [▶]) button.
Displaying the sub-menus	Press the [○] button.
Returning to the previous menu	Move the highlight at the "Return" position, press the [○] button.
Changing the settings	With the highlight at the item to be changed, press the [○] button to select it. Use the [▲], [▼], [◀] and [▶] buttons to change the value, and press the [○] button to enter the change.
Canceling the setting change	Press the [MENU] button.
Exiting the menu operations	Press the [MENU] button for 2 seconds.

[NOTE]

When AW-RP60 is connected, refer to the operating instructions for the controller.

## When performing the operations using the wireless remote control

1. Press the [CAM1], [CAM2], [CAM3] or [CAM4] button to select the unit which is to be operated.
2. Press the [MENU] button for 2 seconds.  
The main menu is displayed.
3. Press the [▲] or [▼] button to bring the cursor to the item to be selected.  
Each time the [▲] or [▼] button is pressed, the cursor moves. The cursor can be moved in the same way using the [◀] and [▶] buttons.
4. Press the [○] button.  
The sub-menu of the selected item is displayed. (Some sub-menu items have a sub-menu of their own.)
5. Press the [▲] or [▼] button to bring the cursor to the item to be set.  
Each time the [▲] or [▼] button is pressed, the cursor moves.  
The cursor can be moved in the same way using the [◀] and [▶] buttons.  
With the cursor at the "Return" position, press the [○] button to return to the previous menu.

**6. Press the [○] button.**

The value of the item to be selected or confirmed.

**7. Press the [▲] or [▼] button to change the setting.**

The setting can be changed in the same way using the [◀] and [▶] buttons.

**8. Press the [○] button.**

The value of the item to be set is entered, and it has a mark sing within.

**9. After the setting has been completed, press the [MENU] button for 2 seconds.**

The menu display is exited.

# Menu Items

---

## ■ Setting the menu items

When the unit's settings are to be selected, the camera menus are displayed on the monitor.

The monitor is connected to the video signal output connector.

The basic camera menu operations involve displaying sub-menus from the Top Menu items, and selecting settings on the sub-menus.

Some sub-menus have menu items for performing more detailed settings.

## Main Menu Screen

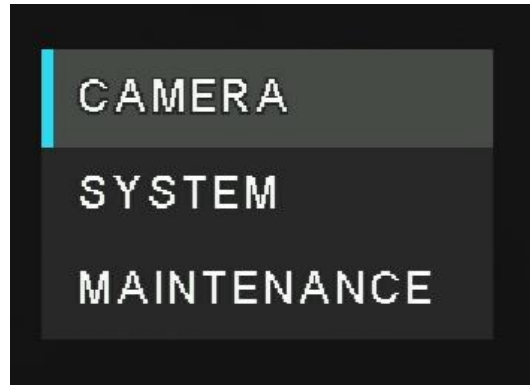

### ■ Camera

Select this to open the camera menu relating to the camera images.

### ■ System

Display the System menu in which the camera's output image settings are configured.

### ■ Maintenance

Display the Maintenance menu which concerns checking the unit's firmware versions, checking the IP address and initialize the settings.

[Note]

The main Menu does not have a "Return" setting.

## Camera Menu

This menu is for the camera image settings. The functions will be varied by selected "scene" mode (Full Auto, Shutter priority, Manual).



# Scene

There are three scene modes – Full Auto, Shutter priority, and Manual.

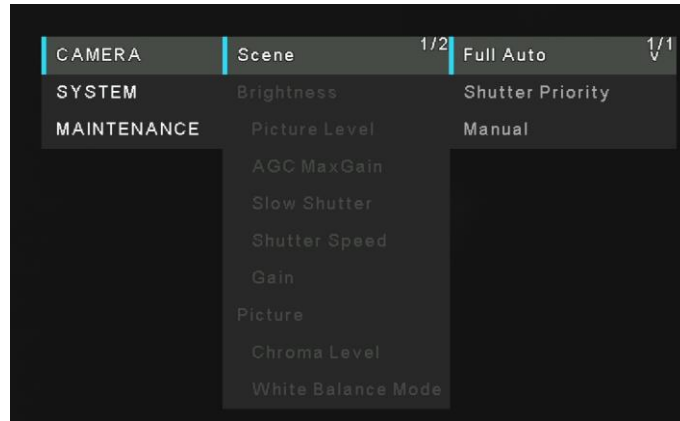

- Full Auto:** In this mode, the optimum settings and adjustments for the shooting conditions at hand are automatically established. But user still can adjust the value of *Picture Level*, *AGC MaxGain*, *Slow Shutter*, *Chroma Level*, and *White Balance Mode*.

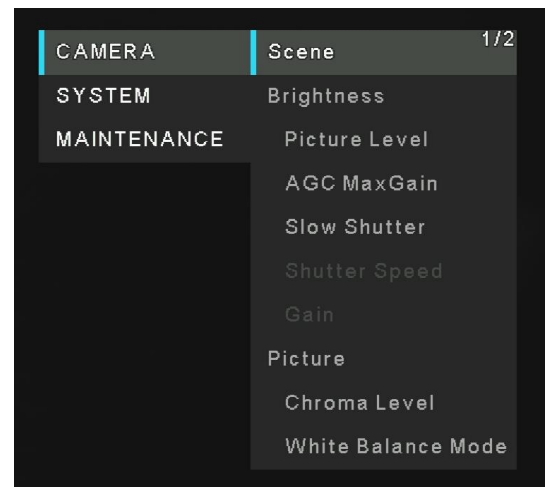

- Shutter Priority:** In this mode, user can adjust the value of *Picture Level*, *AGC MaxGain*, *Shutter Speed*, *Chroma Level*, and *White Balance Mode*.



- Manual:** In this mode, user can adjust the value of *Shutter Speed*, *Gain*, *Chroma Level*, and *White Balance Mode*.



## Picture Level

Adjust the brightness level (0, 1, 2, 3, 4, -1, -2, -3, -4).

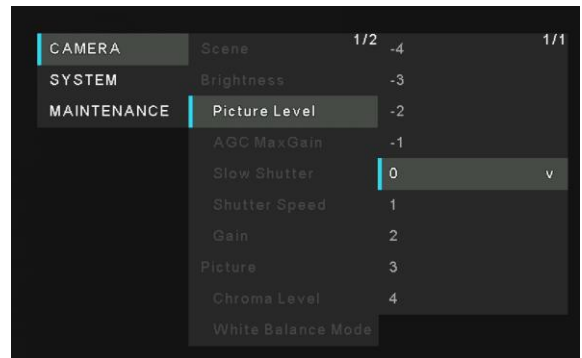

## AGC Max Gain

Set up the maximum gain-up amount value.



## Slow Shutter

Set slow shutter function to "On" or "Off".  
This can only be configured when "Scene" is set to "Full Auto".

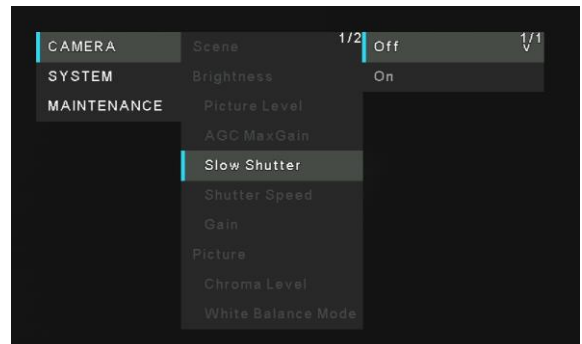

## Shutter Speed

Adjust the shutter speed. When a higher shutter speed is selected, fast-moving subjects do not become blurred easily but the images will be darker.

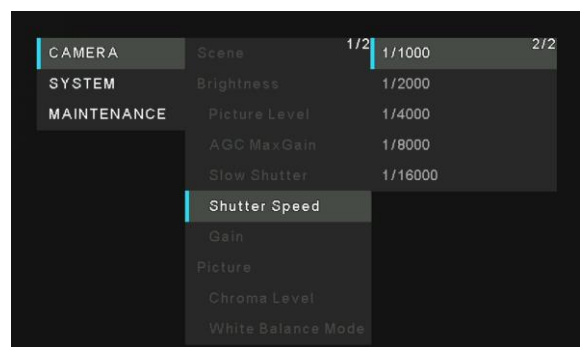

## Gain

In locations which are too dark, adjust the gain upward; conversely, in locations which are too bright, adjust it downward. When “Full Auto” mode is set, the light quantity is adjusted automatically.

The noise increases when the gain is increased.

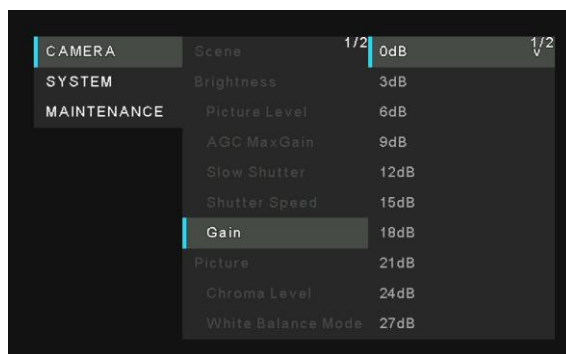

## Chroma Level

Set the color intensity (Chroma level) of the images.

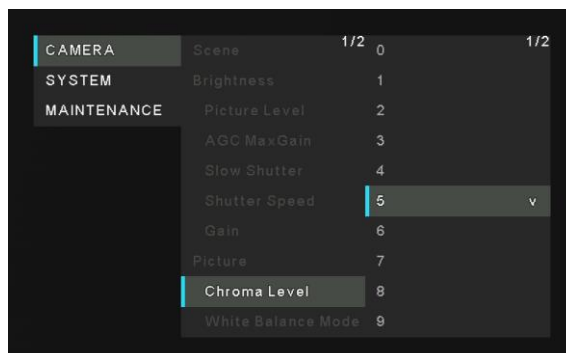

## White Balance Mode

Select the mode when the coloring is not natural because of the nature of the light source or other factors. If the white color serving as the reference can be recognized, subjects can be shot with natural coloring.

- **ATW:** This mode automatically corrects the white balance, even if the light source or color temperature changes.
- **AWB A, AWB B:** When AWB A or AWB B is selected and the white balance is executed, the adjustment results obtained are stored in the memory selected.
- When AWB A or AWB B is then selected, the white balance stored in the selected memory can be recalled.
- **3200K:** This white balance mode is ideal when a 3200K halogen light is used as the light source.
- **5600K:** This white balance mode is ideal when 5600K sunlight or fluorescent lighting is used as the light source.

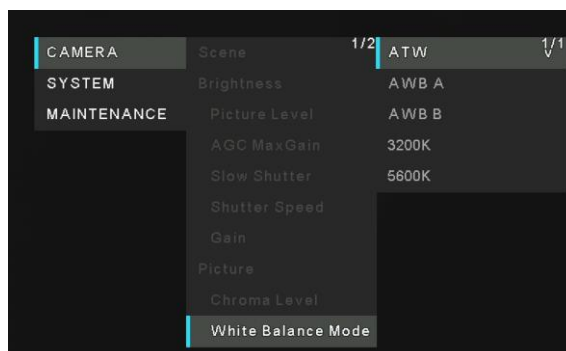

## Detail

Adjust the sharpness (0, 1, 2, 3) of the image.

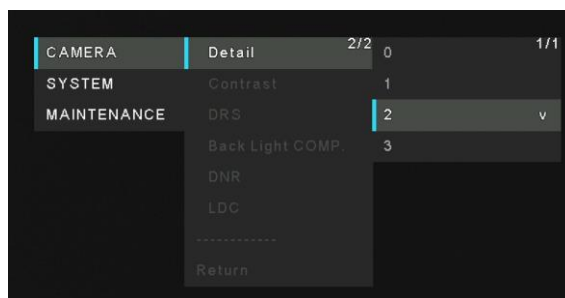



## Contrast

Adjust the contrast level (0, 1, 2, 3, 4) of the image.

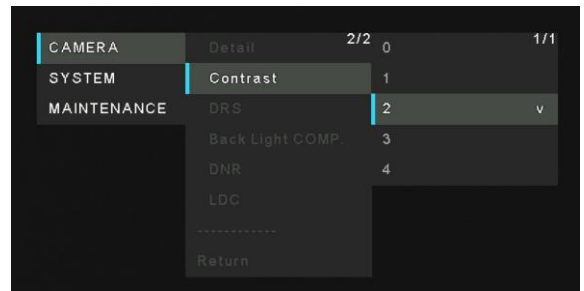

## DRS

Set here is the DRS function which provides just the right amount of compensation when images with significant light/dark differences are displayed.

Depending on the shooting conditions, however, the picture quality may drop with increased noise.

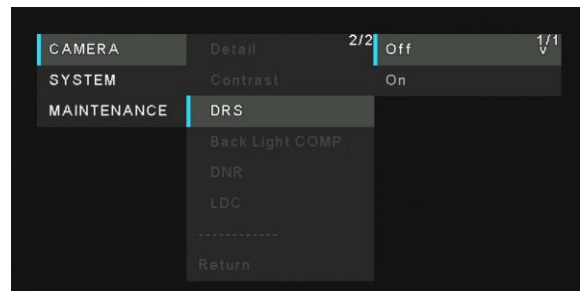

## Back Light COMP

Set backlight compensation function to "On" or "Off".

Under backlight conditions, the function prevents darkening as a result of light striking the backs of subjects, and makes it possible to shoot images in shade or shadow more brightly.

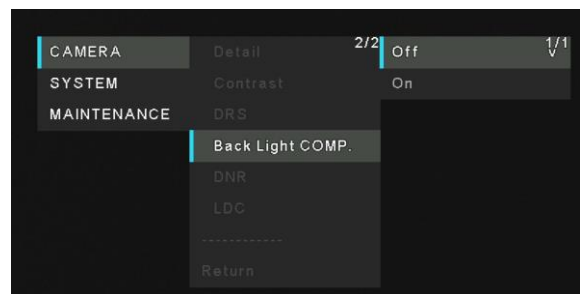

## DNR

Set the level of the digital noise reduction effect so that light, noise-free and clear images will be output even at night and in other low-brightness environments.

When "Low" or "High" is selected, noise can be eliminated.

However, there is an increased possibility that afterimages may occur.

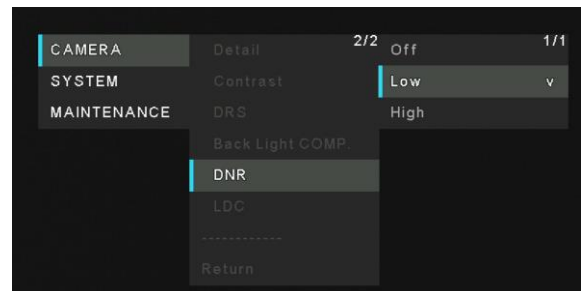

## LDC

Set LDC(Lens Distortion Correction) function to "On" or "Off".

[Note]

When you set the LDC setting to "On", the bent line at the edge of the image turns to a straight line, but the area is stretched.

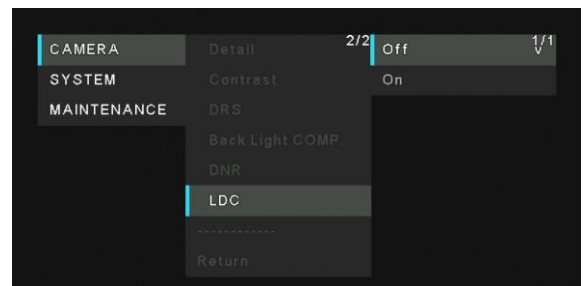

# System Menu

The following will describe the each function in System menu.

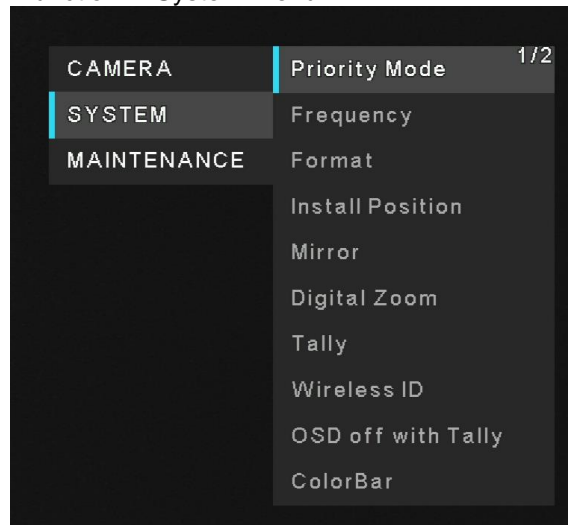

## Priority Mode

Configure the setting for the priority output of video.

- **HDMI(4K):** 4K video is output to an external monitor connected via an HDMI cable.
- **USB(4K):** You can use this unit as a 4K Web camera. The camera can also be controlled from a personal computer.
- **IP(4K):** Enables IP image transmission. IP image transmission of 4K images uses the H.264/H.265 video coding format. This unit cannot display H.264/H.265 format images on the Live screen. To display H.264/H.265 images, use an external device or external software that supports H.264/H.265 images.
- **HDMI/USB:** HD format video is output to an external monitor connected via an HDMI cable. Enables the unit to be used as a Web camera. The camera can also be controlled from a personal computer. (This mode can be set only during PoE power supply.)
- **USB:** Enables the unit to be used as a Web camera. The camera can also be controlled from a personal computer. (This mode can be set only when power is supplied from a PC.)
- **USB (Video Conference):** Enables the unit to be used as a Web camera. The camera can also be controlled from a personal computer. (This mode can be set only when power is supplied from a PC. Under USB (Video Conference) mode, in order to minimize the delay of UVC output, UAC output, HDMI output, and Web live view are disabled.)
- **HDMI:** HD format video is output to an external monitor connected via an HDMI cable. (This mode can be set only when power is supplied from the AC adapter.)
- **IP:** Enables IP image transmission. The IP transmission of H.264/H.265 images is also supported. This unit cannot display H.264/H.265 format images on the Live screen. To display H.264/H.265 images, use an external device or external software that supports H.264/H.265 images.

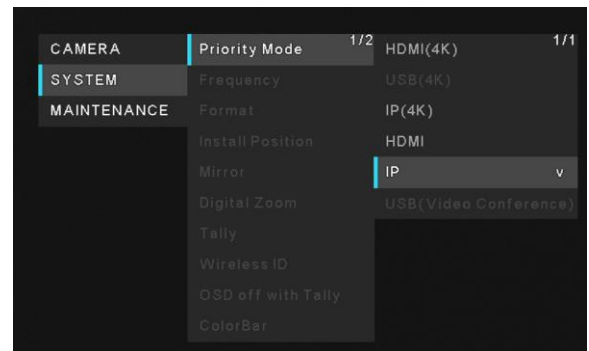

# Frequency

Set the frame frequency – 50Hz, 59.94Hz, or 60Hz.

When the frequency is switched, “Format” is set as following:

Frequency	50Hz	59.94Hz	60Hz
Format	2160/25p	2160/29.97p	2160/30p
	1080/50p	1080/59.94p	1080/60p
	1080/25p	1080/29.97p	1080/30p
	720/50p	720/59.94p	720/60p



When changing the frequency, select “OK” to confirm the changing.



## Format

Change the image format. The image format can differ by the frequency.

Frequency	50Hz	59.94Hz	60Hz
Format	2160/25p	2160/29.97p	2160/30p
	1080/50p	1080/59.94p	1080/60p
	1080/25p	1080/29.97p	1080/30p
	720/50p	720/59.94p	720/60p

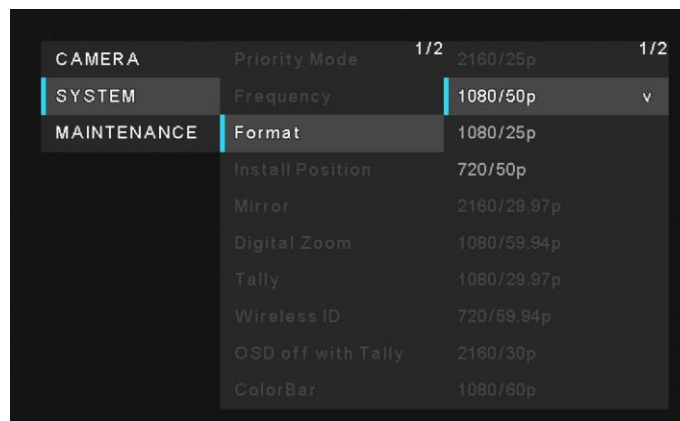

When changing the format, select “OK” to confirm the changing. Finally, select “Yes” to accept the changes.

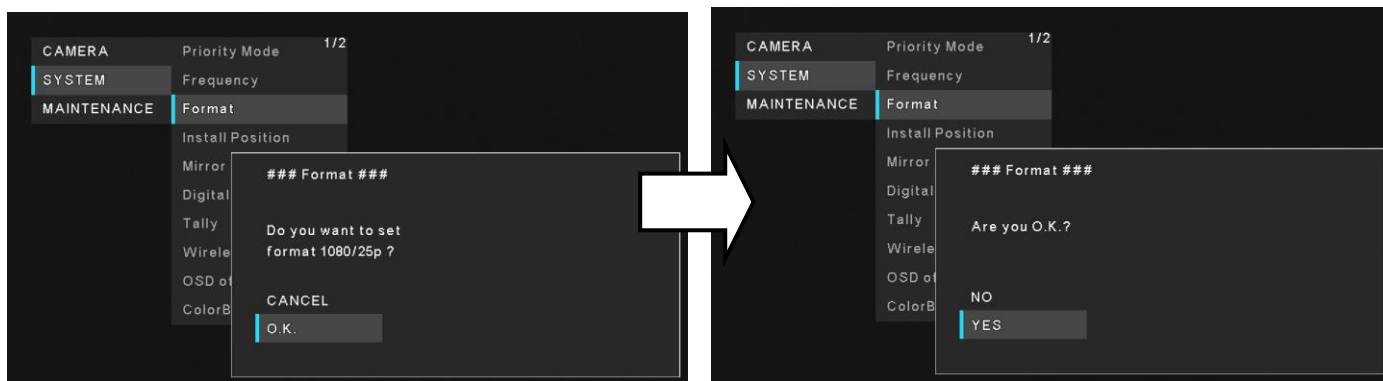

## Install Position

“Desktop” or “Hanging” is selected here as the method used to install the unit.

When “Hanging” has been selected, the top, bottom, left and right of the images will be reversed and up/down/left/right control for panning and tilting will also be reversed.

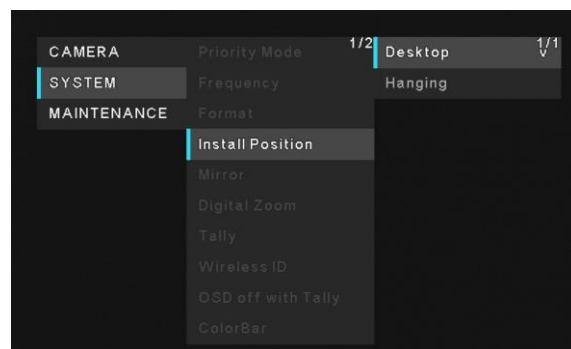

## Mirror

Set the mirror the image to On or Off.

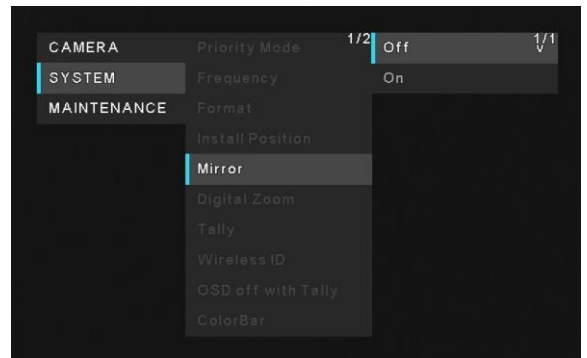

## Digital Zoom

Set the digital zoom to "On" or "Off". Picture quality degrades as zoom increases with digital zoom.

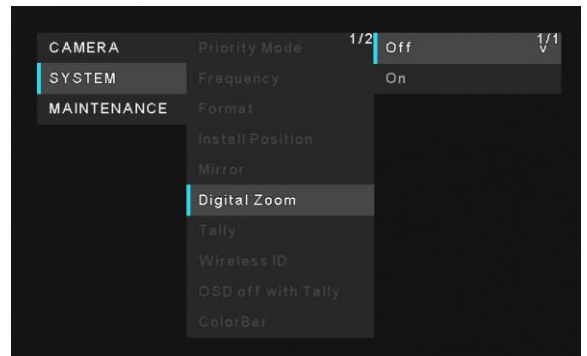

## Tally

"Enable" or "Disable" is set here for the function which turns on or turns off the tally lamp using the tally control signal.

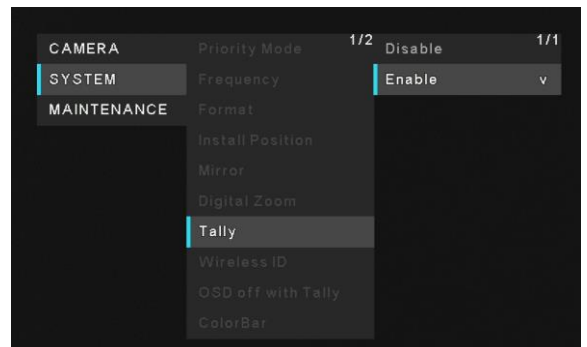

## Wireless ID

Configure the unit's remote control ID. The settings for this item correspond to the [CAM1] to [CAM4] buttons on the wireless remote control.

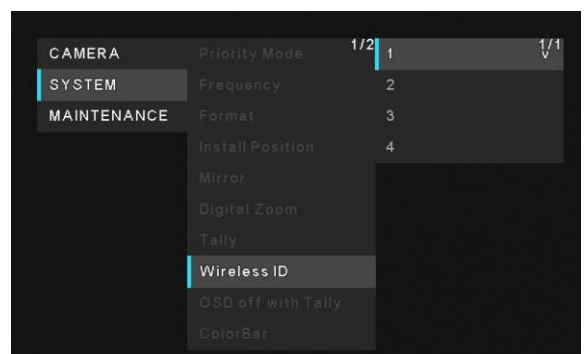

## OSD of with Tally

“Off” or “On” the function that turns off menu and other displays when red tally signals are received via commands. When the red tally signal releases, the menu display will return

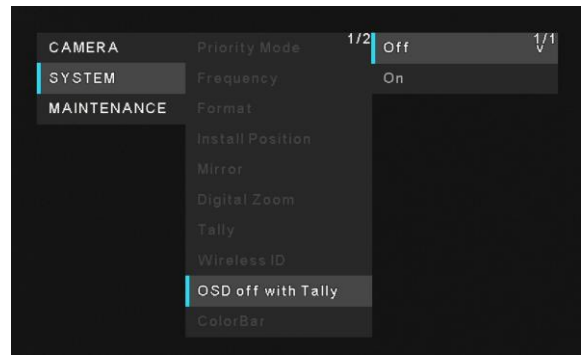

## Color Bar

Switch between camera images and color bars.

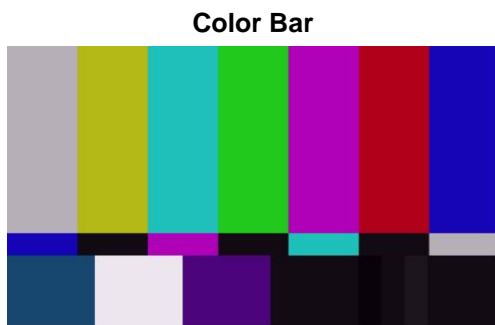

[Note]  
Only HDMI can output color bar.  
IP and USB cannot output color bar.

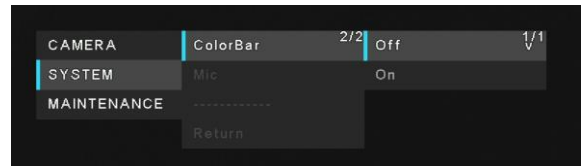

## Mic

Turn audio input off/on.



# Maintenance Menu

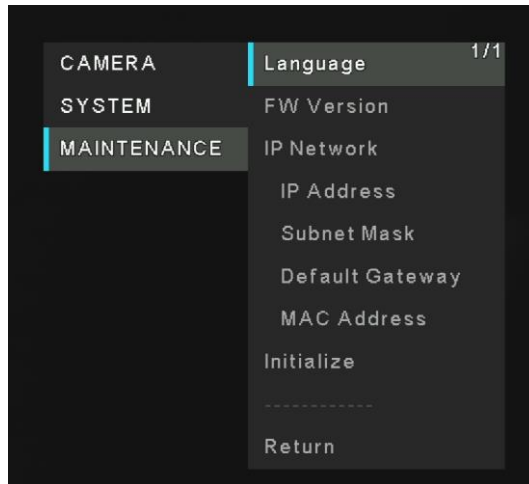

## Language

The system supports three language – English, Japanese, and Simple Chinese.

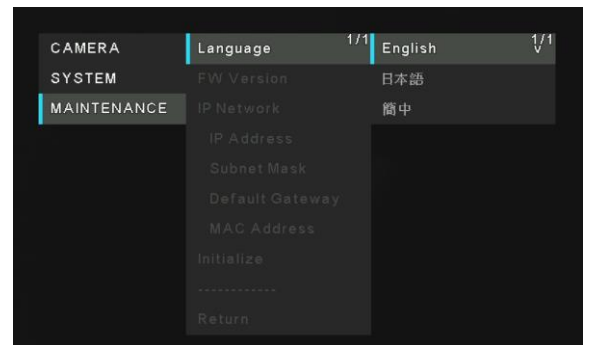

## FW Version

Display the current firmware version of the unit.

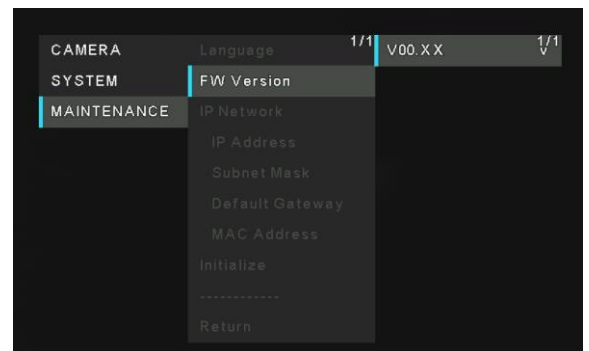

## IP Address

Display the IP address of the unit.

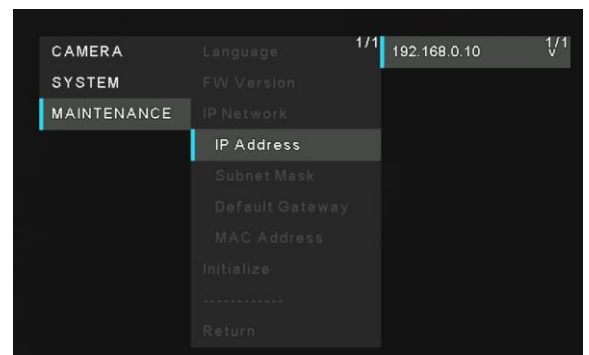

## Subnet Mask

Display the subnet mask of the unit.

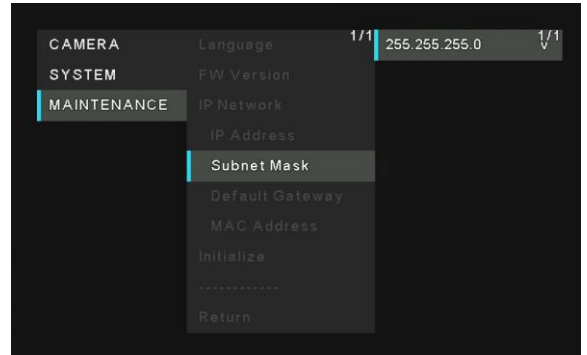

## Default Gateway

Display the default gateway which has been set for the unit.

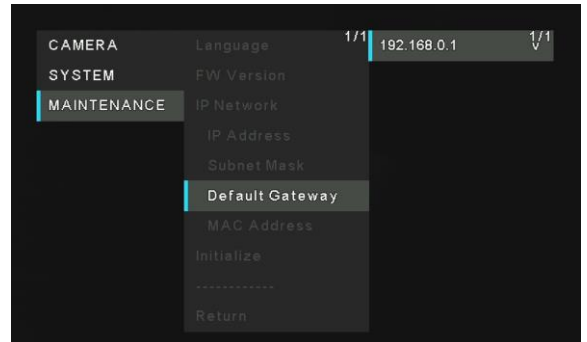

## MAC Address

Display the MAC address of the unit.

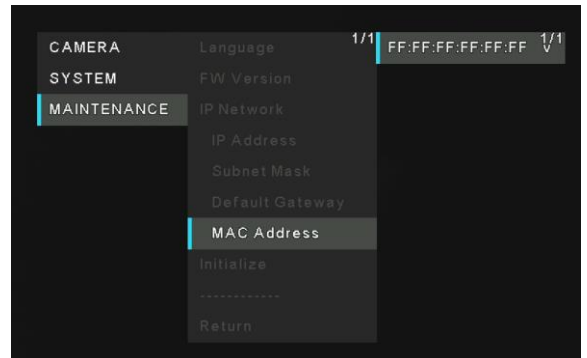

## Initialize

Reset the unit back to the factory default.

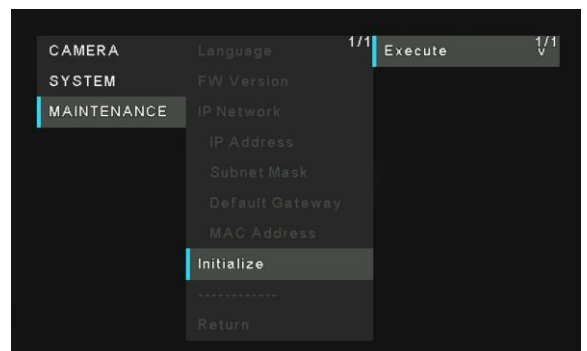



# Menu Table

Main menu	Sub menu	Factory default setting			Selection Items
CAMERA	Scene	Full Auto	Shutter priority	Manual	Full Auto, Shutter priority, Manual
	Brightness				
	Picture Level	0	0	---	-4, -3, -2, -1, 0, +1, +2, +3, +4
	AGC Max Gain	24dB	24dB	---	24dB, 30dB, 36dB, 42dB
	Slow Shutter	Off	---	---	Off, On
	Shutter Speed	---	[50Hz] 1/50 [59.94Hz/60Hz] 1/60 [50Hz]	1/50 [59.94Hz/60Hz] 1/60	[50Hz] 1/1, 1/2, 1/5, 1/10, 1/20, 1/25, 1/50, 1/100, 1/250, 1/500, 1/1000, 1/2000, 1/4000, 1/8000, 1/16000 [59.94Hz/60Hz] 1/1, 1/2, 1/5, 1/10, 1/20, 1/30, 1/60, 1/120, 1/240, 1/480, 1/1000, 1/2000, 1/4000, 1/8000, 1/16000
	Gain	---	---	0dB	0dB, 3dB, 6dB, 9dB, 12dB, 15dB, 18dB, 21dB, 24dB, 27dB, 30dB, 33dB, 36dB, 39dB, 42dB
	Picture				
	Chroma Level	5			0~10
	White Balance Mode	ATW			ATW, AWB A, AWB B, 3200K, 5600K
	Detail	2			0, 1, 2, 3
	Contrast	2			0, 1, 2, 3, 4
	DRS	Off			Off, On
	Back light COMP.	Off	Off	---	Off, On
	DNR	Low			Off, Low, High
	LDC	Off			Off, On
	SYSTEM	Priority mode	<PoE power supply> HDMI/USB <USB terminal power supply(PC Power)> USB <USB terminal power supply(AC Adaptor)> HDMI		
Frequency		59.94Hz			50Hz, 59.94Hz, 60Hz
Format		[50Hz] 1080/50p [59.94Hz] 1080/59.94p [60Hz] 1080/60p			[50Hz] 2160/25p, 1080/50p, 1080/25p, 720/50p [59.94Hz] 2160/29.97p, 1080/59.94p, 1080/29.97p, 720/59.94p [60Hz] 2160/30p, 1080/60p, 1080/30p, 720/60p

Main menu	Sub menu	Factory default setting	Selection Items
SYSTEM	Install Position	Desktop	Desktop, Hanging
	Mirror	Off	Off, On
	Digital Zoom	Off	Off, On
	Tally	Enable	Disable, Enable
	Wireless ID	1	1, 2, 3, 4
	OSD off with Tally	Off	Off, On
	Color Bar	Off	Off, On
	Mic	On	Off, On
MAINTENANCE	Language	English	English, Japanese(日本語), Simplified Chinese(簡中)
	FW Version	Version at shipping	---
	IP Network		
	IP Address	192.168.0.10	---
	Subnet Mask	255.255.255.0	---
	Default Gateway	192.168.0.1	---
	MAC Address	MAC Address of the unit	---
Initialize	Execute	Execute, Cancel	

## **Web Screen Start-up**

---

With a personal computer connected to the unit, it is possible to view the camera's IP videos or select various settings from the web browser.

The LAN crossover cable is used when connecting a personal computer directly to the unit's LAN connector for IP control, and the LAN straight cable is used when making the connection through a switching hub.

Select an IP address for the personal computer within the private address range while ensuring that it is different from the address of the unit. Set the subnet mask to the same address as the unit.

**[Note]**

If you need to change the IP address and subnet mask, be sure to ask your dealer to make these changes for you.

Unit's IP address and subnet mask (factory settings)\*<sup>1</sup>

IP address: 192.168.0.10

Subnet mask: 255.255.255.0

\*<sup>1</sup> The factory default for the private address range is between 192.168.0.1 and 192.168.0.255.

If the controller and web browser are being used at the same time, the content selected using the controller may not be reflected on the web browser display.

When using both the controller and web browser, be absolutely sure to check the settings using the controller or menu.

For details of the required personal computer environment, refer to Required Personal Computer Environment.
---

# Connecting to Web Screen by Using a PC

The procedure is explained here using Windows screens (Internet Explorer). When using other browsers, some screen displays will be different, but the procedure is similar.

## 1. Start the web browser of the personal computer.

Use one of the web browsers below depending on the operating system installed in the personal computer.

Operating system	Web browser
Windows	Windows 7 64/32-bit/Internet Explorer 11 Windows 10/Internet Explorer 11 Windows 10/Microsoft Edge Windows 10/Google Chrome
Mac OS	macOS 10.14 macOS 10.13 macOS 10.12 OS X 10.11  Safari Google Chrome

## 2. Enter the IP address you configured on the Easy IP Setup Software in the address bar of the web browser.

- IPv4 address entry example:  
http://URL registered with IPv4 address  
http://192.168.0.10/
- IPv6 address entry example:  
http://[URL registered with IPv6 address]  
http://[2001:db8::10]/

[Note]

- If the HTTP port number has been changed from “80”, enter “http://<camera IP address>:<port number>” in the address bar. Example: http://192.168.0.11:8080
- If the unit is located on the local network, configure proxy server settings on the web browser ([Setup] > [Network]) so that a proxy server is not used for the local address.

## 3. Display the live screen [Live].

The web screen appears. You can switch to the web setup screen [Setup] when necessary.



[Note]

- Standby mode is the factory default setting, so switch to Power ON mode.
- Depending on the firewall settings on your personal computer, transmitted images may not be displayed. If this occurs, change the firewall settings and change the settings to permit communications with your web browser.
- When an attempt is made to display multiple IP images on one personal computer, IP videos may not be displayed depending on the performance of the personal computer concerned.
- Images on the web screen are displayed in JPEG.
- The JPEG image frame rate may be slower depending on the network environment, performance of your personal computer, subject of the video, and access volume.

## Switching between Live and Setup Screen

When the live screen is displayed, click the [Setup] button.

For details on the web setup screen, see "[Web Screen Configuration](#)" section.



When the web setup screen is displayed, click the [Live] button to switch to live screen.

For details on the live screen, see "[Web Live Screen Operation](#)" section.



[Note]

- During Standby mode, the [Setup] button is disabled, and you cannot switch to the [Setup] screen.
- If the unit is switched to Standby mode from another terminal while the [Setup] screen is displayed, the display will switch to the live screen after a few seconds.

# Web Live Screen Operation

You can display images from the camera on a personal computer and perform camera operations, such as pan, tilt, and zoom.

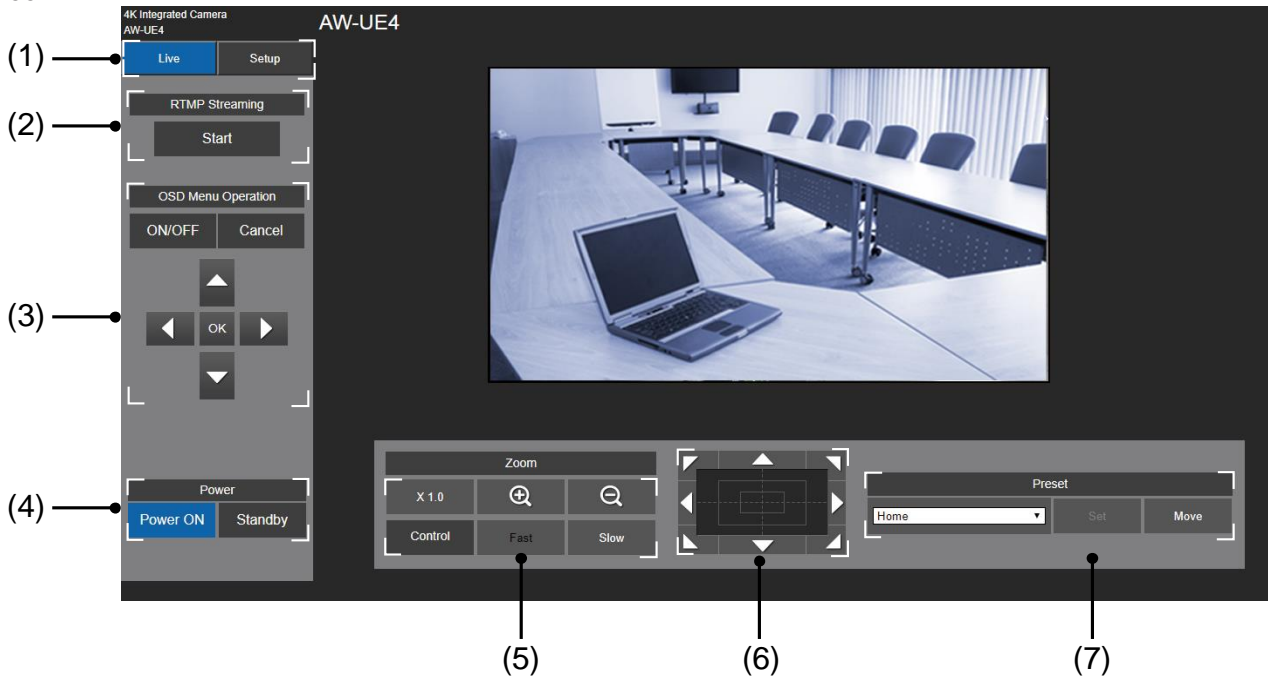

Name	Function
(1) Live/Setup	Click [Live] to switch to live screen. Click [Setup] to switch to setup screen.
(2) RTMP	Setup for uploading the camera's live view to the broadcasting platform (ex: YouTube). Click [Start] button to start uploading the live image to pre-registered broadcasting platform. When RTMP starting, the start button will turn into stop button. To stop, click [Stop] button To setup RTMP, please refer " <a href="#">RTMP setting</a> " section.
(3) OSD Menu Operations	<p><b>ON / OFF</b> : Use this to select whether the camera's on- screen displays are to be shown.</p> <p>            The items are selected using the [▲] [▼] [◀] [▶] buttons.            If a selected item has a sub menu, this sub menu is displayed by pressing the [OK] button.         </p> <p><b>Cancel</b> : It cancels the selection of the setting which is being changed. It restores the pre-change setting.</p> <p>[Note] On-screens displays are not displayed on JPEG images on web screens.</p>
(4) Power	<p><b>Power ON</b> : Turn the unit on.</p> <p><b>Standby</b> : Set the unit to Standby mode.</p> <p>In the Standby mode, all the buttons on the live screen except for the [Power ON] button and [Standby] button are disabled.</p> <p>[Note]            If [Power ON] or [Standby] is selected too quickly, the status selected and the display shown may not correspond. In a case like this, follow the steps below to restore the correct status display: <b>For Windows:</b>            Press the [F5] key on the keyboard of the personal computer.  <b>For Mac:</b>            Press the [Command] + [R] keys on the keyboard of the personal computer.            The pan/tilt position return to the place just before entering STANDBY mode when returning from STANDBY mode to <b>POWER ON</b> mode.            If the power is turned off, the pan/tilt position returns to the initial state.</p>

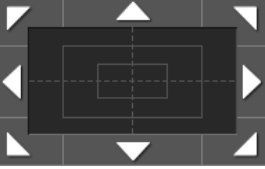
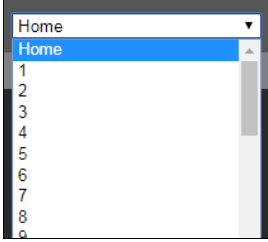
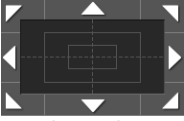
Name	Function
(5) Zoom	<div data-bbox="470 152 608 203" style="border: 1px solid black; padding: 2px; display: inline-block;">X 1.0</div> : Use this to adjust the zoom (magnification) to 1.0x <div data-bbox="470 208 608 259" style="border: 1px solid black; padding: 2px; display: inline-block;">⊕</div> : Use this to adjust the zoom (magnification) in the “Tele” direction. <div data-bbox="470 264 608 315" style="border: 1px solid black; padding: 2px; display: inline-block;">⊖</div> : Use this to adjust the zoom (magnification) in the “Wide” direction. <div data-bbox="470 320 608 394" style="border: 1px solid black; padding: 2px; display: inline-block;">Fast</div> <div data-bbox="611 320 748 394" style="border: 1px solid black; padding: 2px; display: inline-block;">Slow</div> : Select the speed at which zoom operations are to be performed.
(6) 	<p>To adjust the image in the horizontal or vertical direction (panning or tilting), left-click the pad and the buttons.</p> <p>It is possible to operate with the central grid pattern in the dragged state, with the speed of the pan/tilt increasing as it approaches the outside of the pad.</p>
(7) Preset	<div data-bbox="470 629 738 869" style="border: 1px solid gray; padding: 5px; display: inline-block;">  </div> <p>Select the preset number or home position from drop-down list.</p> <p>Click [Move] to go to the pre-set position.</p> <p>Using  to adjust the unit position and click [Set] to register the preset position.</p>

# Web Screen Configuration

## Select the Setup Screen

In live screen, click the [Setup] button to switch to setup screen.

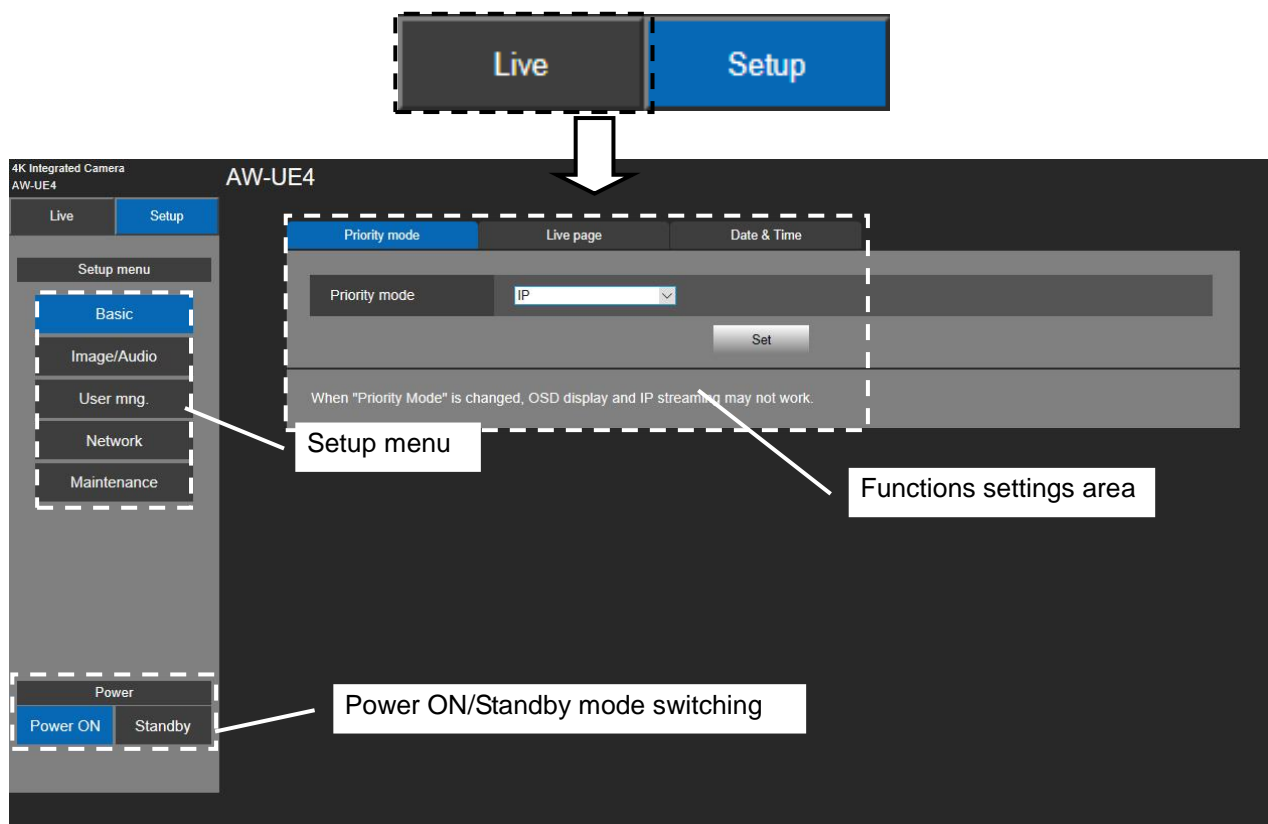



# Basic Settings

From the Setup menu click [Basic] button to display the Basic settings page.  
In basic settings, user can select [Priority mode] and setup name of [Live page].

## Selecting Priority Mode

Configure the setting for the priority output of video.

Click [Setup] > [Basic] > [Priority Mode]

Click [Set] to save the configuration.

- **HDMI(4K):** 4K video is output to an external monitor connected via an HDMI cable.
- **USB(4K):** You can use this unit as a 4K Web camera. The camera can also be controlled from a personal computer. When the unit is used as a 4K-compatible Web camera, the frame rate will be fixed at 5 fps.
- **IP(4K):** Enables IP image transmission. IP image transmission of 4K images uses the H.264/H.265 video coding format. This unit cannot display H.264/H.265 format images on the Live screen. To display H.264/H.265 images, use an external device or external software that supports H.264/H.265 images.
- **HDMI/USB:** HD format video is output to an external monitor connected via an HDMI cable. Enables the unit to be used as a Web camera. The camera can also be controlled from a personal computer. (This mode can be set only during PoE power supply.)
- **USB:** Enables the unit to be used as a Web camera. The camera can also be controlled from a personal computer. (This mode can be set only when power is supplied from a PC.)
- **USB (Video Conference):** Enables the unit to be used as a Web camera. The camera can also be controlled from a personal computer.
- **HDMI:** HD format video is output to an external monitor connected via an HDMI cable. (This mode can be set only when power is supplied from the AC adapter.)
- **IP:** Enables IP image transmission. The IP transmission of H.264/H.265 images is also supported. This unit cannot display H.264/H.265 format images on the Live screen. To display H.264/H.265 images, use an external device or external software that supports H.264/H.265 images.

[Note]

- When "Priority Mode" is changed, OSD display and IP streaming may not work.
- When "Priority Mode" is set to IP(4K), USB(4K) or HDMI(4K), Frame rate of Video is automatically set to 30p/29.97p/25p.
- Under **USB (Video Conference)** mode, in order to minimize the delay of UVC output, UAC output, HDMI output, and Web live view are disabled.

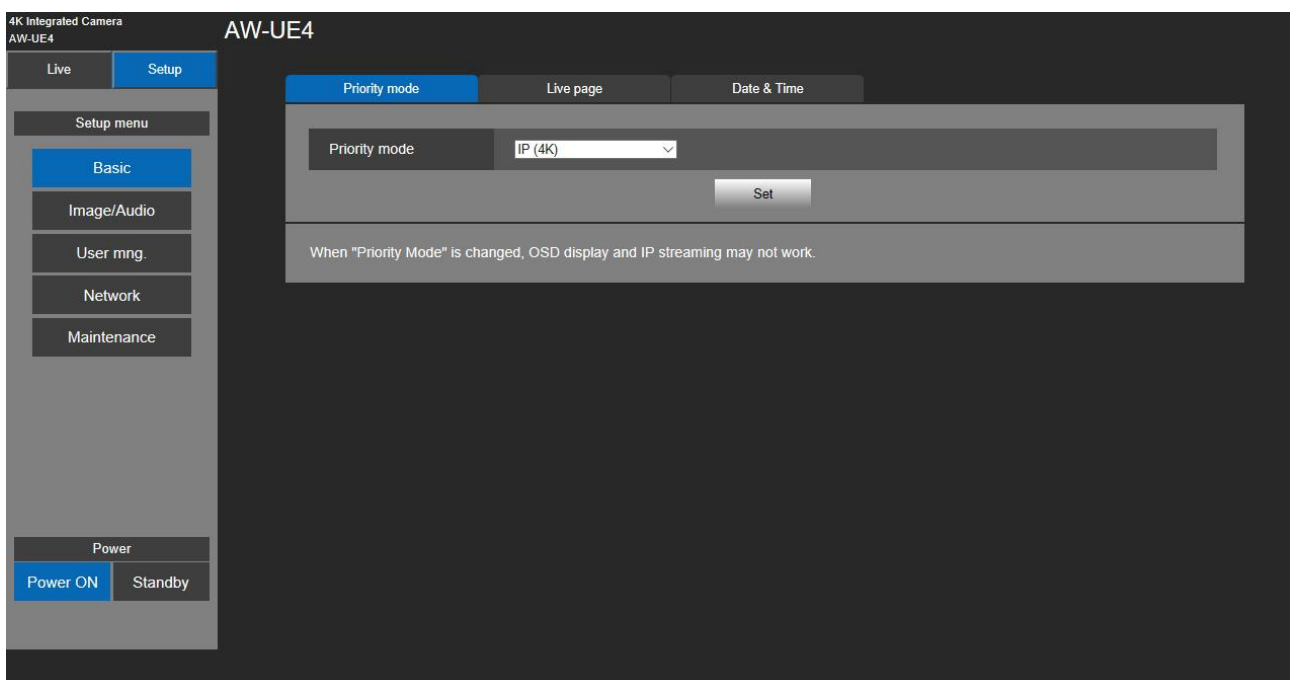

## Live Page (Camera Title)

Input the name of the camera here.

Click [Setup] > [Basic] > [Live Page]

When the [Set] button is clicked, the input name appears in the camera title display area.

[Note]

- The factory default setting is the model number of the unit.
- You can enter between 0 to 20 characters.
- The following characters can be displayed.

Numeric characters	0123456789
Alphabetical characters (upper and lower cases)	ABCDEFGHIJKLMNOPQRSTUVWXYZ vwxyz
Symbols	#%+=, - _ ^ / @ :

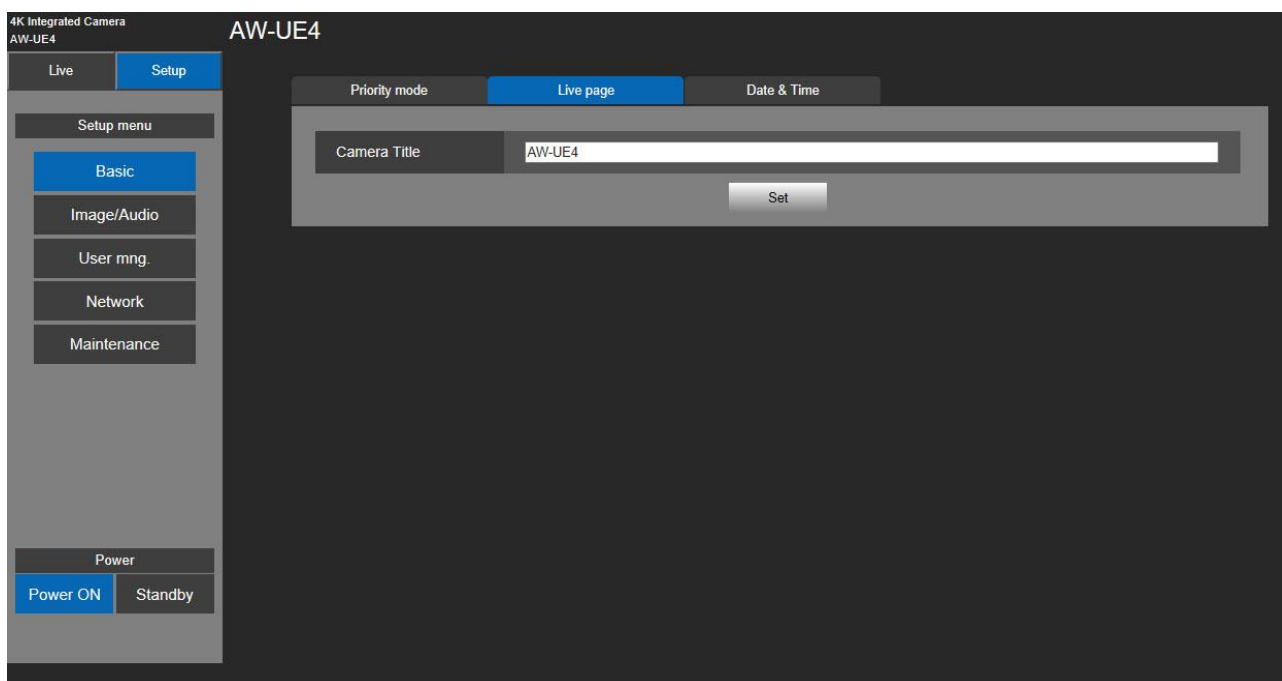

## Clock settings tab (Date&Time)

Configure the settings for the clock.

Set the clock using any of the three methods: "PC synchronization", "NTP", and "Manual".

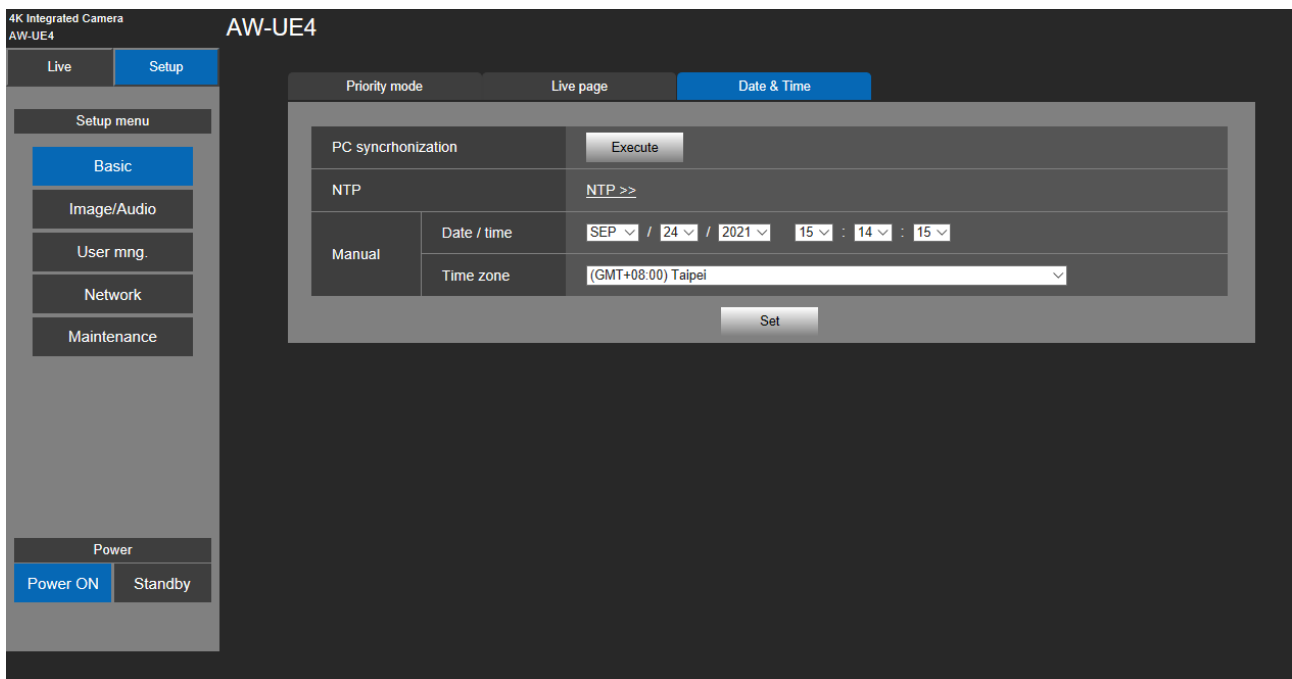

### ■ setup

#### PC synchronization

If you click the [Execute] button, the settings are configured by synchronizing the unit to the date and time of the connected personal computer.

[Note]

- The time zone of the personal computer is not reflected on the unit.  
Set the time zone on the unit.

#### NTP

If you click "NTP>>", the settings screen for the NTP server appears. (page 74)

#### Manual - Date/time

Configure the settings for the month, day, and year and for the hour, minute, and second.

[Note]

- The data display format is Mmm/DD/YYYY.
- The time is in the 24-hour format.

#### Manual - Time zone

Selects the time zone according to the region where the camera is being used.

Factory settings: (GMT) Greenwich Mean Time : Dublin, Edinburgh, Lisbon, London

# Image/Audio Settings

## Video over IP

The JPEG image and H.264/H.265 image settings as well as the settings related to image quality are selected in here. Click [Setup] > [Image/Audio] > [Video over IP]

[Note]

- IP control can be performed but if you do not want to perform IP image transmission, set [H.264/H.265 transmission] to [Off].
- Images and audio are not synchronized. Therefore, images and audio may be slightly out of sync.
- The audio may skip depending on the network environment.
- Please do not change the following menu during IP streaming.  
Priority mode, Frequency , Format, Install Position, Mirror, Mic.

### ■ JPEG

Set JPEG image settings.

Click [Set] to save the configuration.

- **Image capture size:** Select the resolution (**1280x720 or 640x360**) for JPEG images.
- **Frame rate:** Set the frame rate (**10 or 30**) for JPEG images.

JPEG	
Image capture size	1280x720
Frame rate	10
<input type="button" value="Set"/>	

### ■ H.264/H.265

Set H.264/H.265 image settings.

Click [Set] to save the configuration.

[Note]

Only JPEG images can be displayed on web screens.

### **Stream transmission**

Whether to transmit images is set here. The default is On.

When Priority mode is USB(4K) or HDMI(4K), the stream transition is off.

### **Codec**

Select the H.264 or H.265 as image codec.

H.264/H.265	
Stream transmission	<input type="radio"/> Off <input checked="" type="radio"/> On
Codec	<input type="radio"/> H.264 <input checked="" type="radio"/> H.265

### **Image capture size**

Select the resolution (**640x360, 1280x720, 1920x1080, or 3840x2160**) for H.264/H.265 images.

Image capture size	1920x1080
Transition priority	1920x1080
Frame rate	

## ■ H.264/H.265 (continued)

### Frame rate

Set the frame rate for H.264 /H.265 images.

50Hz	5fps, 10fps, 25fps, 50fps* *not support in IP(4K)Priority mode
59.94Hz/60Hz	5fps, 15fps, 30fps, 60fps* *not support in IP(4K) Priority mode

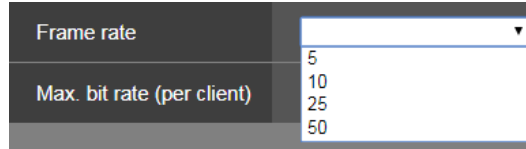

The screenshot shows a configuration panel with two sections. The top section is labeled 'Frame rate' and contains a dropdown menu with the following options: 5, 10, 25, and 50. The bottom section is labeled 'Max. bit rate (per client)' and is currently empty.

### Max bit rate (per client)

Specify the H.264/H.265 bit rate per client (**1024kbps, 1536kbps, 2048kbps, 3072kbps, 4096kbps, 6144kbps, 8192kbps, 10240kbps, 12288kbps, 14336kbps, 16384kbps, 20480kbps, 24576kbps, and 32768kbps**).

The default is 14336kbps.

[Note] When bit rate is set higher than 8192kbps, the bit rate during RTMPS transmission will be 8192kbps.

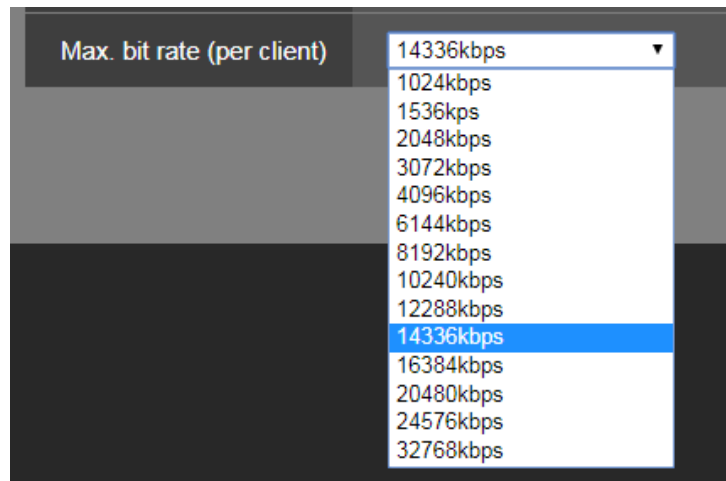

The screenshot shows a configuration panel with a dropdown menu for 'Max. bit rate (per client)'. The menu is open, displaying a list of bit rate options: 1024kbps, 1536kps, 2048kbps, 3072kbps, 4096kbps, 6144kbps, 8192kbps, 10240kbps, 12288kbps, 14336kbps (highlighted in blue), 16384kbps, 20480kbps, 24576kbps, and 32768kbps.

# Image Settings

Image adjustment and preset position setup.

Click [Setup] > [Image/Audio] > [Image]

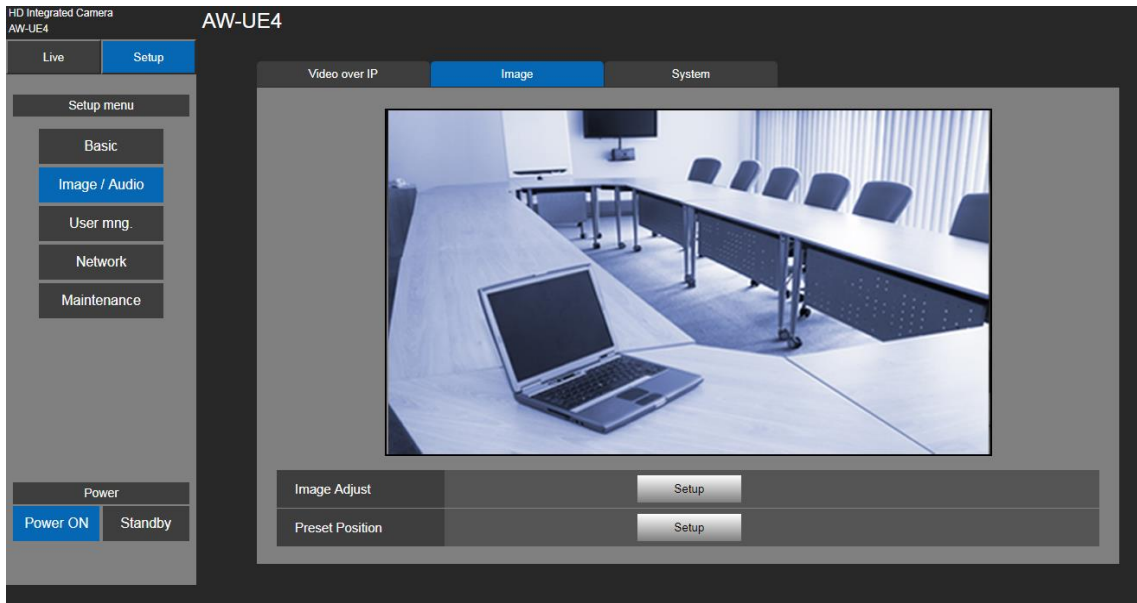

## ■ Image Adjust

Click [Setup] button to call out image adjust dialog.

Click [Close] button to exit from image adjust dialog.

The image mode has three types – Full Auto, Shutter priority, and Manual.

[Note] Setting data which changed are reflected immediately.

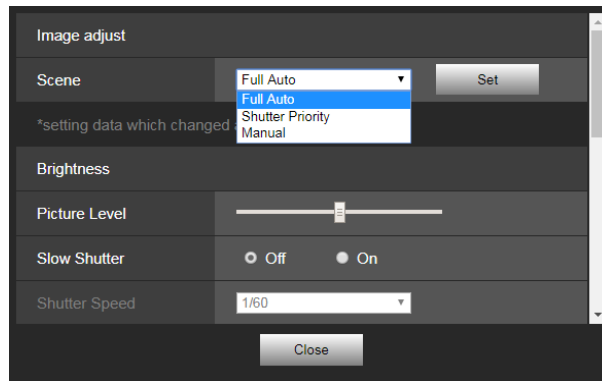

**Full Auto:** In this mode, the optimum settings and adjustments for the shooting conditions at hand are automatically established. But user still can adjust the value of *Picture Level*, *AGC MaxGain*, *Slow Shutter*, *Chroma Level*, and *Whit Balance Mode*.

**Shutter Priority:** In this mode, user can adjust the value of *Picture Level*, *AGC MaxGain*, *Shutter Speed*, *Chroma Level*, and *Whit Balance Mode*.

**Manual:** In this mode, user can adjust the value of *Shutter Speed*, *Gain*, *Chroma Level*, and *Whit Balance Mode*.

Each adjustable function will be described in follows.

### **Picture Level**

Adjust the picture quality (-4,-3,-2,-1, 0, 1, 2, 3, 4). Move the scroll bar to adjust the value.



### Slow Shutter

Set slow shutter function to “Off” or “On”.  
This can only be configured when “Scene” is set to “Full Auto”.

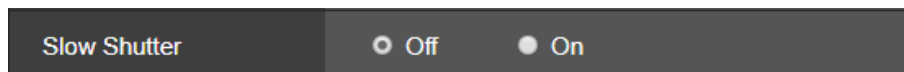

### Shutter Speed

Adjust the shutter speed. When a higher shutter speed is selected, fast-moving subjects do not become blurred easily but the images will be darker.

Value: 1/1, 1/2, 1/5, 1/10, 1/20, 1/25, 1/30, 1/50, 1/60, 1/100, 1/120, 1/240, 1/250, 1/480, 1/500, 1/1000, 1/2000, 1/4000, 1/8000, 1/16000.



### Gain

In locations which are too dark, adjust the gain upward; conversely, in locations which are too bright, adjust it downward. When “Full Auto” mode is set, the light quantity is adjusted automatically.

The noise increases when the gain is increased. The default is 0dB.

Value: 0dB, 3dB, 6dB, 12dB, 15dB, 18dB, 21dB, 24dB, 27dB, 30dB, 33dB, 36dB, 39dB, 42dB.



### AGC Max Gain

Set up the maximum gain-up amount value (24dB, 30dB, 36dB, 42dB). The default is 24dB.



### Chroma Level

Set the color intensity (Chroma level) of the images. Move the scroll bar to adjust the value(0,1,2,3,4,5,6,7,8,9,10). The default is 5.



### White Balance Mode

Select the mode when the coloring is not natural because of the nature of the light source or other factors. If the white color serving as the reference can be recognized, subjects can be shot with natural coloring.

Click [Execute] button to apply the setting.

The default is ATW.

- **ATW:** This mode automatically corrects the white balance, even if the light source or color temperature changes.
- **AWB A, AWB B:** When AWB A or AWB B is selected and the white balance is executed, the adjustment results obtained are stored in the memory selected.  
When AWB A or AWB B is then selected, the white balance stored in the selected memory can be recalled.
- **3200K:** This white balance mode is ideal when a 3200K halogen light is used as the light source.
- **5600K:** This white balance mode is ideal when 5600K sunlight or fluorescent lighting is used as the light source.

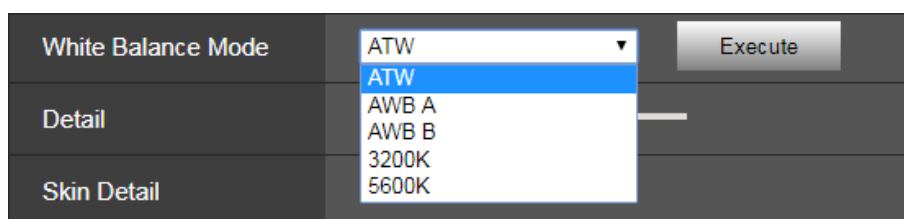

### Detail

Adjust the sharpness (0, 1, 2, 3) of the image. Move the scroll bar to adjust the value.  
The default is 2.



### Contrast

Adjust the Contrast level (0,1,2,3,4).  
The default is 2.



### DRS

Set here is the DRS function which provides just the right amount of compensation when images with significant light/dark differences are displayed.  
Depending on the shooting conditions, however, the picture quality may drop with increased noise.  
The default is off.

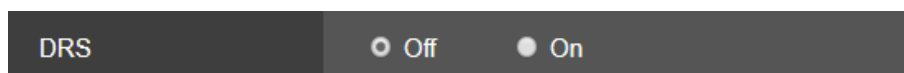

### Back Light COMP

Set backlight compensation function to "On" or "Off".  
Under backlight conditions, the function prevents darkening as a result of light striking the backs of subjects, and makes it possible to shoot images in shade or shadow more brightly.  
The default is off.

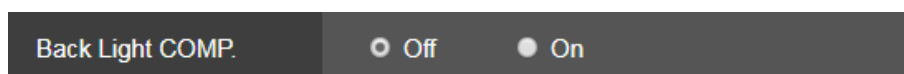

### DNR

Set the level of the digital noise reduction effect so that light, noise-free and clear images will be output even at night and in other low-brightness environments.  
When "Low" or "High" is selected, noise can be eliminated. However, there is an increased possibility that afterimages may occur.  
The default is low.

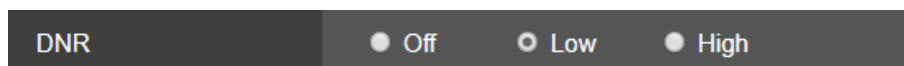





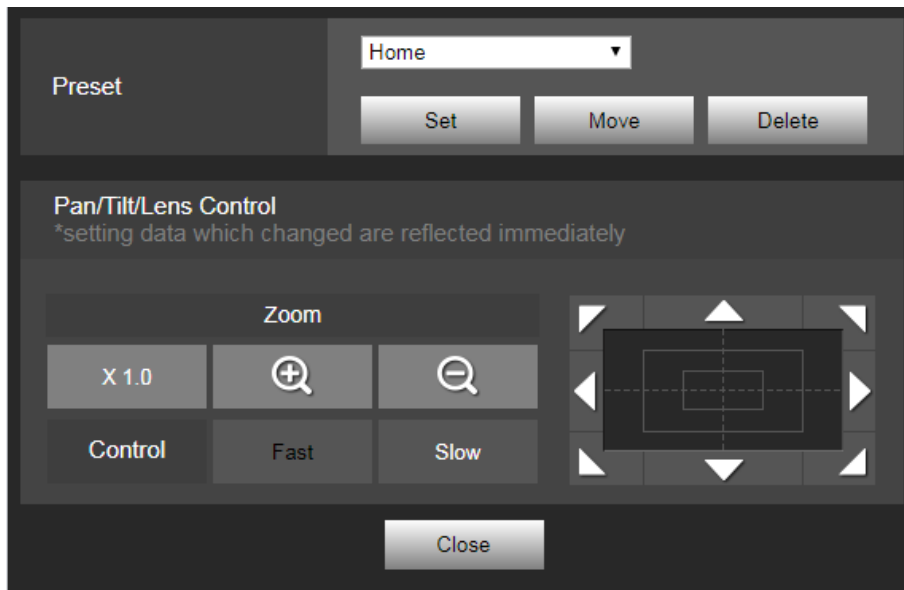

■ **Preset Position**

Click [Setup] button to call out preset position dialog.

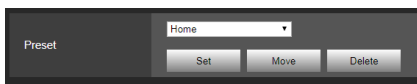
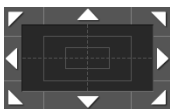
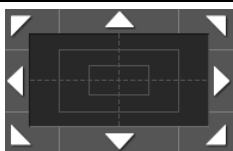
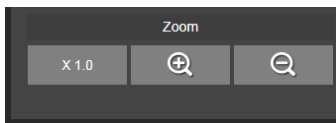
Click [Close] button to exit from image adjust dialog.



	<p>Select the preset number or home position from drop-down list. Click [Move] to go to the pre-set position.</p> <p>Using  to adjust the unit position and click [Set] to register the preset position.</p>
	<p>To adjust the image in the horizontal or vertical direction (panning or tilting), left-click the pad and the buttons. It is possible to operate with the central grid pattern in the dragged state, with the speed of the pan/tilt increasing as it approaches the outside of the pad.</p>
	<p> : Use this to adjust the zoom (magnification) to 1.0x   : Use this to adjust the zoom (magnification) in the “Tele” direction.   : Use this to adjust the zoom (magnification) in the “Wide” direction.</p>
	<p>Select the speed at which zoom operations are to be performed.</p>

# System Settings

Click [Setup] > [Image/Audio] > [System]

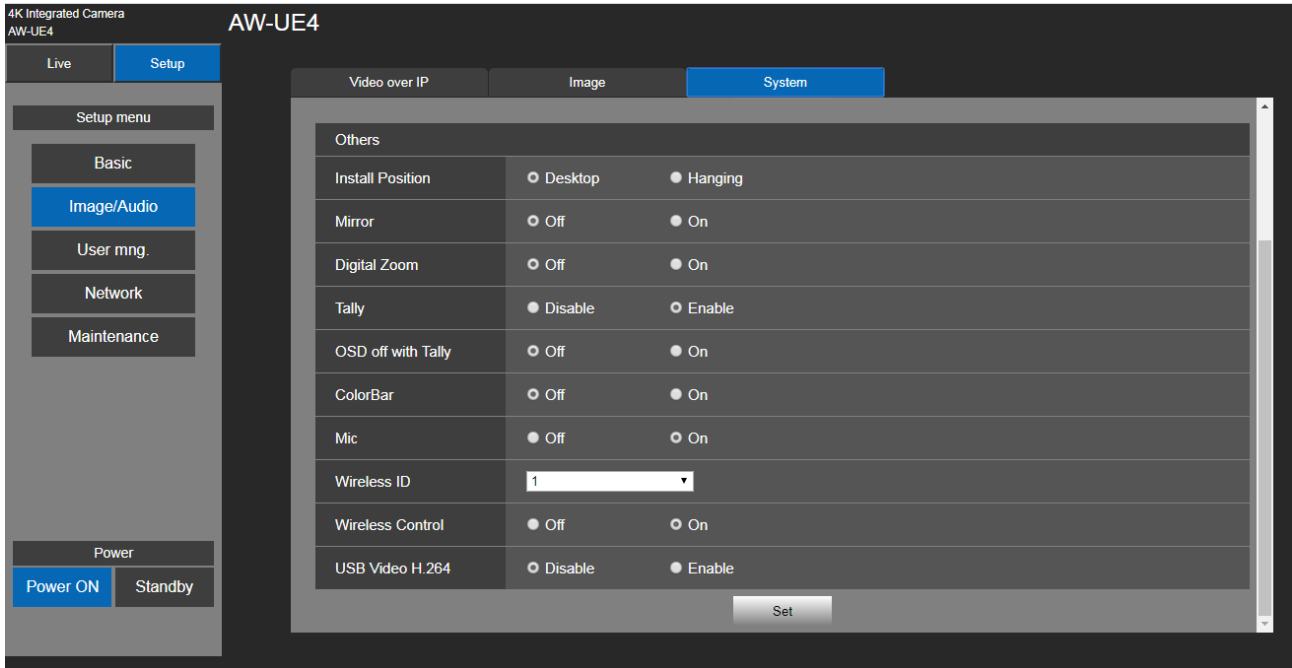

## ■ Output

Click [Set] button to save the configuration

### **Format**

Change the image format. The image format can differ by the frequency.

Frequency	50Hz	59.94Hz	60Hz
Format	2160/25p	2160/29.97p	2160/30p
	1080/50p	1080/59.94p	1080/60p
	1080/25p	1080/29.97p	1080/30p
	720/50p	720/59.94p	720/60p

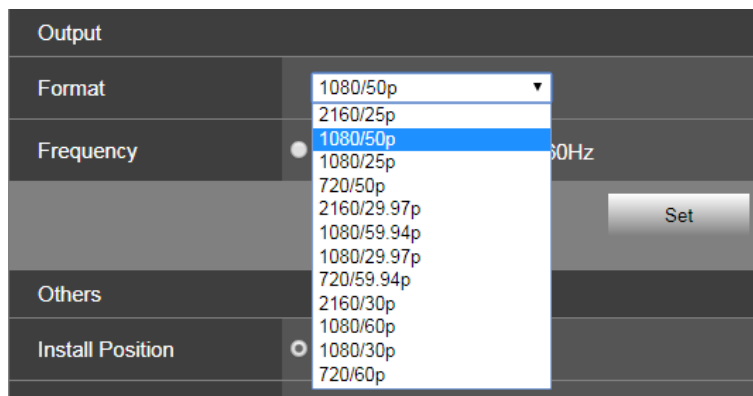

### Frequency

Set the frame frequency – 50Hz, 59.94Hz, or 60Hz.

When the frequency is switched, “Format” is set as following:

Frequency	50Hz	59.94Hz	60Hz
Format	2160/25p	2160/29.97p	2160/30p
	1080/50p	1080/59.94p	1080/60p
	1080/25p	1080/29.97p	1080/30p
	720/50p	720/59.94p	720/60p

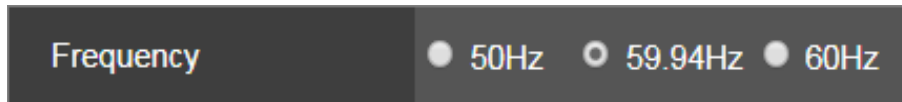

### Others

Click [Set] button to save the configuration

### Install Position

“Desktop” or “Hanging” is selected here as the method used to install the unit.

When “Hanging” has been selected, the top, bottom, left and right of the images will be reversed and up/down/left/right control for panning and tilting will also be reversed.

The default is desktop.



### Mirror

Set the mirror the image to On or Off. The default is off.



### Digital Zoom

Set the digital zoom to “On” or “Off”. Picture quality degrades as zoom increases with digital zoom.

The default is off.



### Tally

“Enable” or “Disable” is set here for the function which turns on or turns off the tally lamp using the tally control signal. The default is disabled.

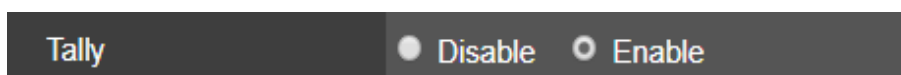

### OSD off with Tally

“Off” or “On” the function that turns off menu and other displays when red tally signals are received via commands.

The default is off.

When the red tally signal releases, the menu display will return



### Color Bar

Switch between camera images and color bars. The default is camera.

[Note]

Only HDMI can output color bar.

IP and USB cannot output color bar.



### Mic

Turn audio input off/on. The default is "On".

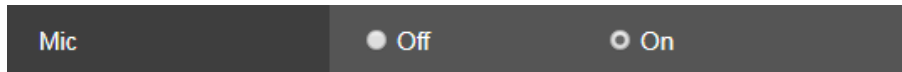

### Wireless ID

Configure the unit's remote control ID. The settings for this item correspond to the [CAM1] to [CAM4] buttons on the wireless remote control. The default is 1.

Value: 1, 2, 3, 4



### Wireless Control

Switch the power ON/OFF control with the wireless remote control. The default is "On".

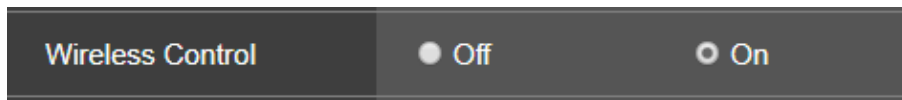

### USB Video H.264

Switch the "Enable" or "Disable" of USB Video H.264. The default is "Disable".

[Note]

Using the USB Video with Skype for Business, set the USB Video H.264 to "Disable".

Please upgrade the firmware version of this unit to Ver. 1.32 or above.

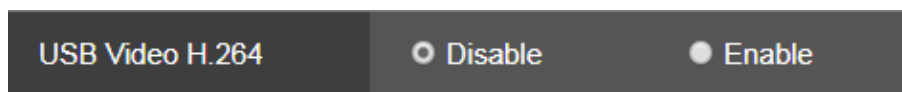

# User Mng.(User Management)

Click [Setup] > [User Mng.]

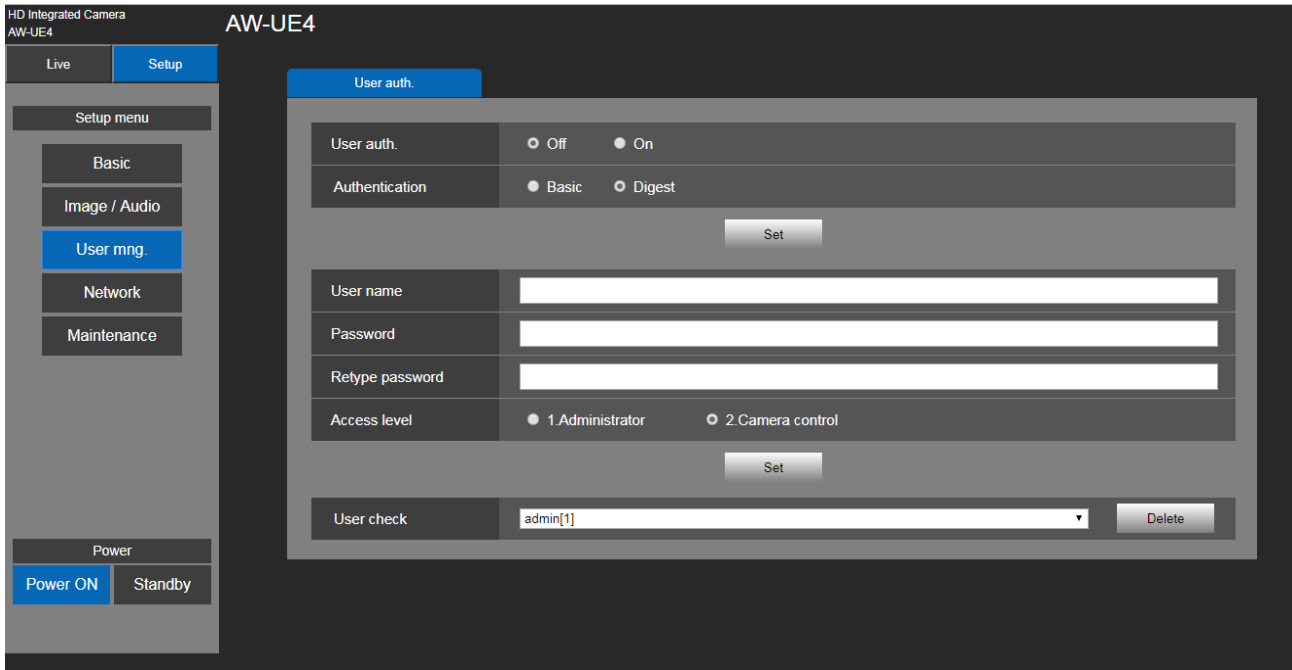

## User auth.(User authentication)

Configure the user authentication settings for the personal computers and mobile terminals that can access the unit. Up to 9 users can be registered.

- User auth.:** Turn user authentication to off/on. Click [Set] button to save the configuration. The default is off.



- Authentication:** Specify the method of user authentication to use. Click [Set] button to save the configuration. The default is Digest.

Basic	Use basic authentication.
Digest	Use digest authentication.



- **User name:** Enter the user name here (1 to 32 characters). Click [Set] button to save the configuration. The following characters can be displayed.

Numeric characters	0123456789
Alphabetical characters (upper and lower cases)	ABCDEFGHIJKLMNOPQRSTUVWXYZ abcdefghijklmnopqrstuvwxyz
Symbols	#%+=, -_!@.~

User name

- **Password/Retype password:** Enter the password here (4 to 32 characters). Re-enter the password to confirm.

Password

Retype password

- **Access level:** Select the user access level (**Administrator or Camera control**). Click [Set] button to save the configuration. The default is Camera control.

1.Administrator	This access level allows the user to perform all the unit's operations.
2.Camera control	This access level allows only live screen [Live] operations to be performed.

Access level  1.Administrator  2.Camera control

- **User Check:** Delete the user accounts registered in the unit. You can delete selected users by clicking the [Delete] button at the right.

User check

# Network Settings

Configure network and RTMP setting in the Network setup screen.  
Click [Setup] > [Network].

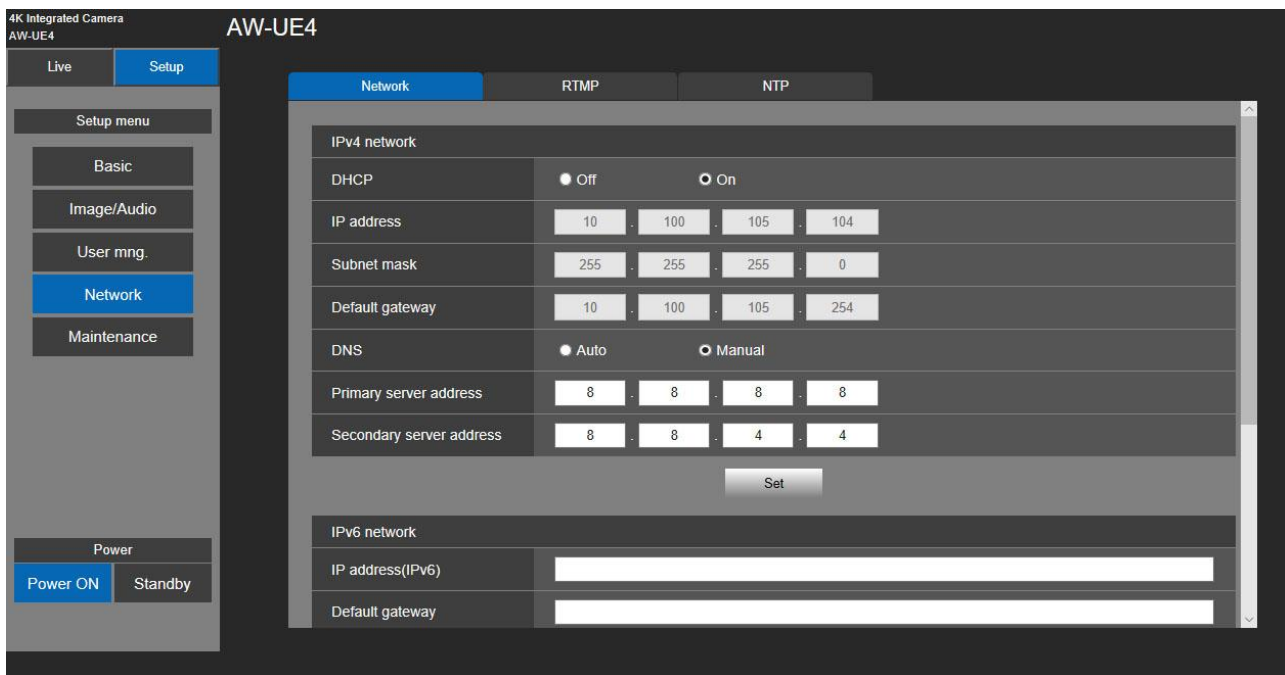

## Network

Setup IPv4 and IPv6 network.  
Click [Setup] > [Network] > [Network].

### ■ IPv4 network

Click [Set] button to save the configuration.

#### **DHCP**

Select the method in which the IP address is configured. The default is off.



#### **IP Address**

Input the unit's IP address here when the DHCP function is not going to be used. Input an address that will not duplicate an existing IP address which has been set for a personal computer or another network camera. The default IP is 192.168.0.10



#### [Note]

Multiple IP addresses cannot be used even when the DHCP function is used. For details on the DHCP server settings, consult your network administrator.

#### **Subnet Mask**

Input the unit's subnet mask here if the DHCP function is not going to be used.  
The default is 255.255.255.0.

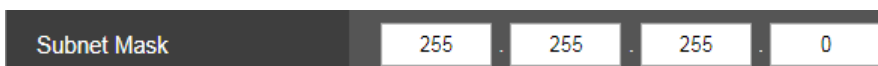

### Default Gateway

Input the unit's default gateway if the DHCP function is not going to be used.  
The default is 192.168.0.1.

Default Gateway	10	100	93	254
-----------------	----	-----	----	-----

[Note]

Multiple IP addresses cannot be used for the default gateway even when the DHCP function is used.  
For details on the DHCP server settings, consult your network administrator.

### DNS

Whether the DNS server address is to be acquired automatically (Auto) or manually (Manual) is input here. The default is Manual.

If [Manual] has been selected, the DNS settings must be established. If [Auto] is selected when the DHCP function is going to be used, the DNS server address is acquired automatically.

For details, consult your system administrator.

DNS	<input type="radio"/> Auto	<input checked="" type="radio"/> Manual
-----	----------------------------	---

### Primary Server Address/Secondary Server Address

Input the IP address of the DNS server if the [Manual] setting has been selected for [DNS].  
For details on the IP address of the DNS server, consult your system administrator.

Primary Server Address				
------------------------	--	--	--	--

[Note]

Multiple IP addresses cannot be used for the default gateway even when the DHCP function is used.  
For details on the DHCP server settings, consult your network administrator.

### ■ IPv6 network

Click [Set] button to save the configuration

### IP Address(IPv6)

The IPv6 address must be entered manually.  
Be sure to enter an address unique from other devices.

IP address(IPv6)	
------------------	--

### Default Gateway

Enter the default gateway for the unit's IPv6 network.  
The default is blank.

Default gateway	
-----------------	--

### Primary server address/Secondary server address

Enter the IPv6 address of the DNS server.  
For details on the IPv6 address of the DNS server, consult your system administrator.

Primary server address	
Secondary server address	



## RTMP Setting

Make RTMP transmission settings.

Click [Setup] > [Network] > [RTMP].

Click [Set] button to save the configuration.

[Note]

- Switch to the appropriate method of registering RTMP transmission server information suited to the setting information notified from the RTMP transmission server you are using.
- The Stream Key setting field is displayed only when [Type2] is set.
- Please do not change the following menu during RTMP streaming.  
Priority mode, Frequency , Format, Install Position, Mirror, Mic.

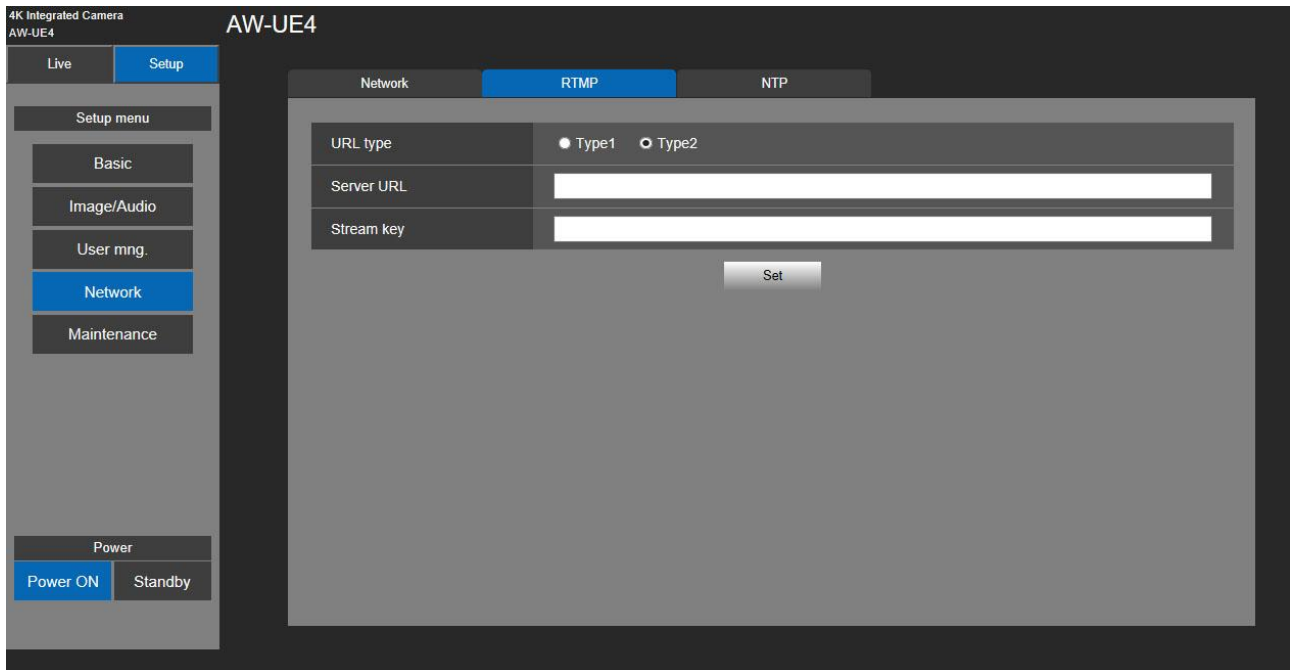

- “Max. bit rate (per client)” is set higher than 8192kbps, the bit rate during RTMPS transmission will be 8192kbps.

### ■ URL Type

Select the method for registering the information for the RTMP transmission server. The default is [Type2].

Type1	Specify to set the server URL and RTMP stream key as a set in [Server URL].
Type2	Specify to individually set the server URL and RTMP stream key in [Server URL] and [Stream Key].

### ■ Server URL

Set the URL for the RTMP server to be transmitted to.

### ■ Stream Key

The stream key obtained from the RTMP server is set during streaming only when the service is set to [Type2].

# NTP

Settings relating to the NTP server address and port No. are performed.  
 This item's setting is reflected when the [Set] button is pressed.

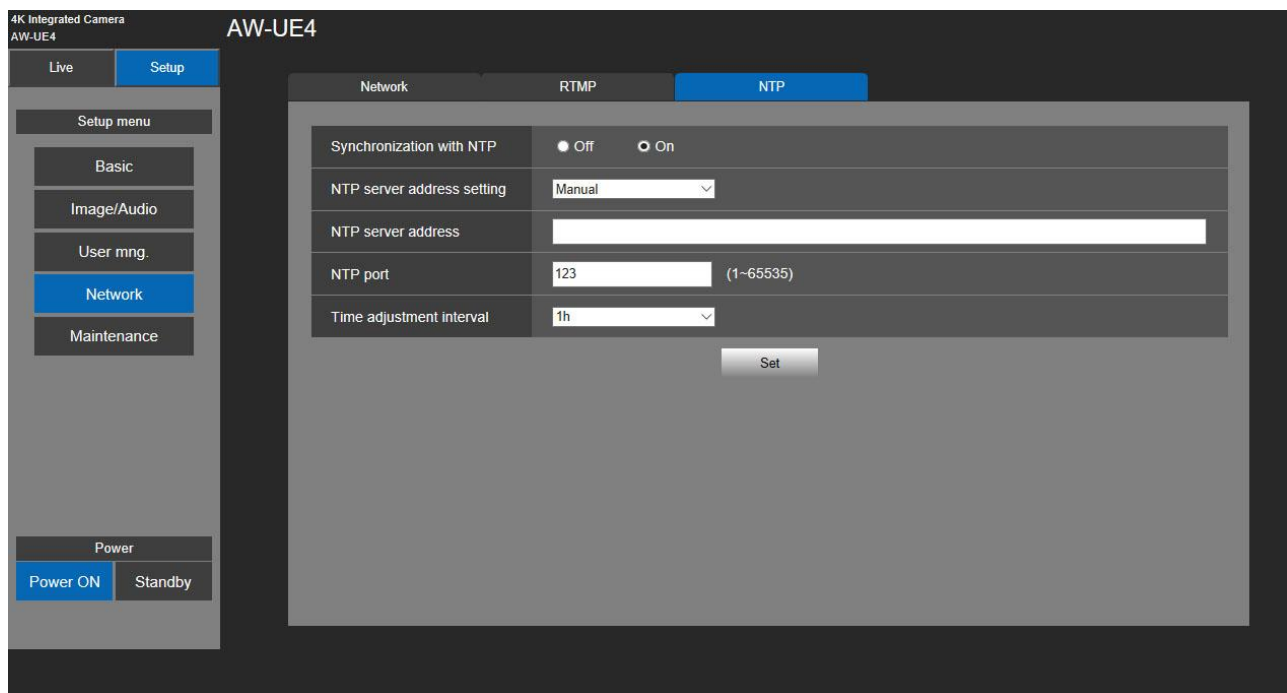

## ■ Synchronization with NTP

Set whether to use an NTP server by selecting “On” or “Off”.  
 Setting value:

On	Uses an NTP server. (Synchronizes the date and time with the NTP server.)
Off	Does not use an NTP server.

Factory settings: Off

## ■ NTP server address setting

Select the method to acquire the NTP server address.  
 Setting value:

Auto	Acquires the NTP server address from the DHCP server.
Manual	Sets the address by inputting the NTP server address in [NTP server address].

Factory settings: Manual

[Note]

- To acquire the NTP server address from the DHCP server, you need to set “DHCP” (page 71) of “IPv4 network” on the [Network] tab of the network setup screen [Network] to “On”.

## ■ NTP server address

When [Manual] is selected in the [NTP server address setting], input the IP address or host name of the NTP server.

Maximum number of characters	0 to 128 half-size characters
Characters that can be entered	Half-size alphanumeric characters, half-size symbols ∴ _ -

Factory settings: blank

[Note]

- To input the [NTP server address] host name, the [DNS] setting must be selected on the [Network] tab of the network setup screen [Network] (page 72).

■ **NTP port**

Input the port No. of the NTP server.

Port Nos. that can be selected: 1 to 65535

Factory settings: 123

■ **Time adjustment interval**

Selects the interval (1 to 24 hours in 1-hour increments) for acquiring the time from the NTP server.

Setting range: 1h to 24h

Factory settings: 1h

# Maintenance Settings

Among the various maintenance operations performed on this screen are language, system version upgrading and initialization of the unit.

The Maintenance screen consists of four settings: [Language], [Product info.], and [Default reset].

Click [Setup] > [Maintenance].

## Language

Set the unit system's language.

Click [Setup] > [Maintenance] > [Language].

Click [Set] button to save the configuration.

The language only supports [English], [Simplified Chinese], and [Japanese].

The default is English.

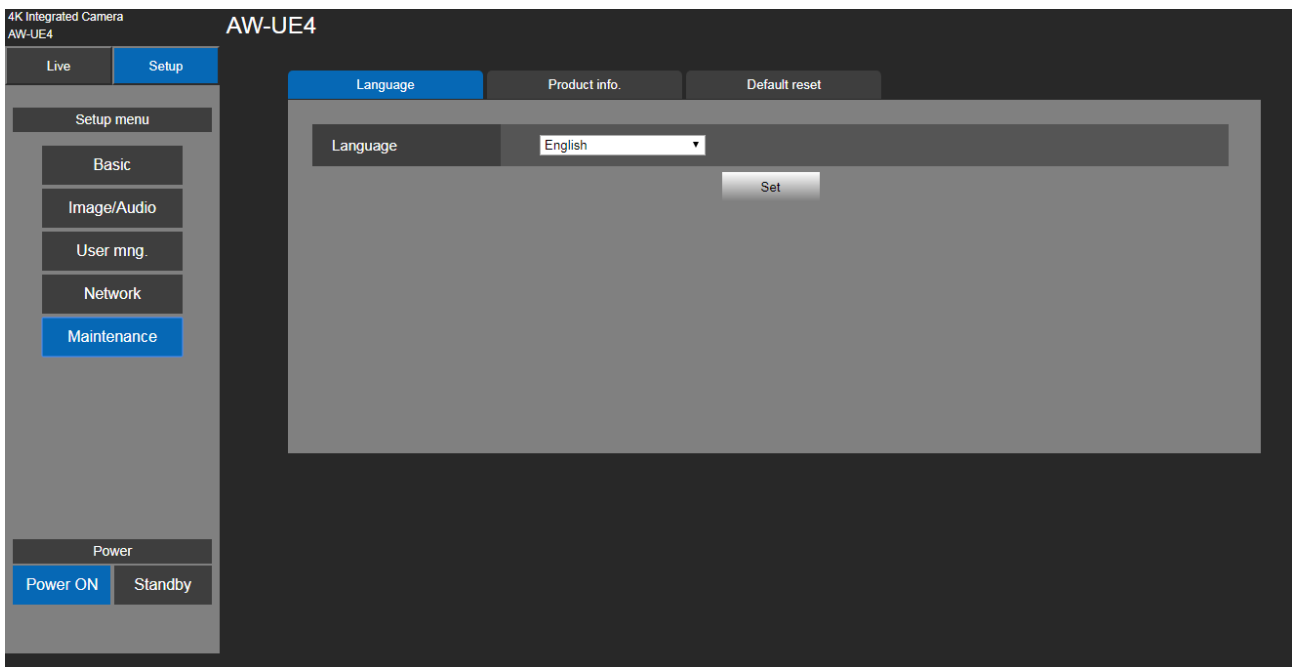

## Product Info.

Click [Setup] > [Maintenance] > [Product Info.].

The versions of the unit's software can be checked on this screen.

The [Model no.], [MAC address], [Serial no.], [Firmware version] and [Operation Time] of the unit is displayed.

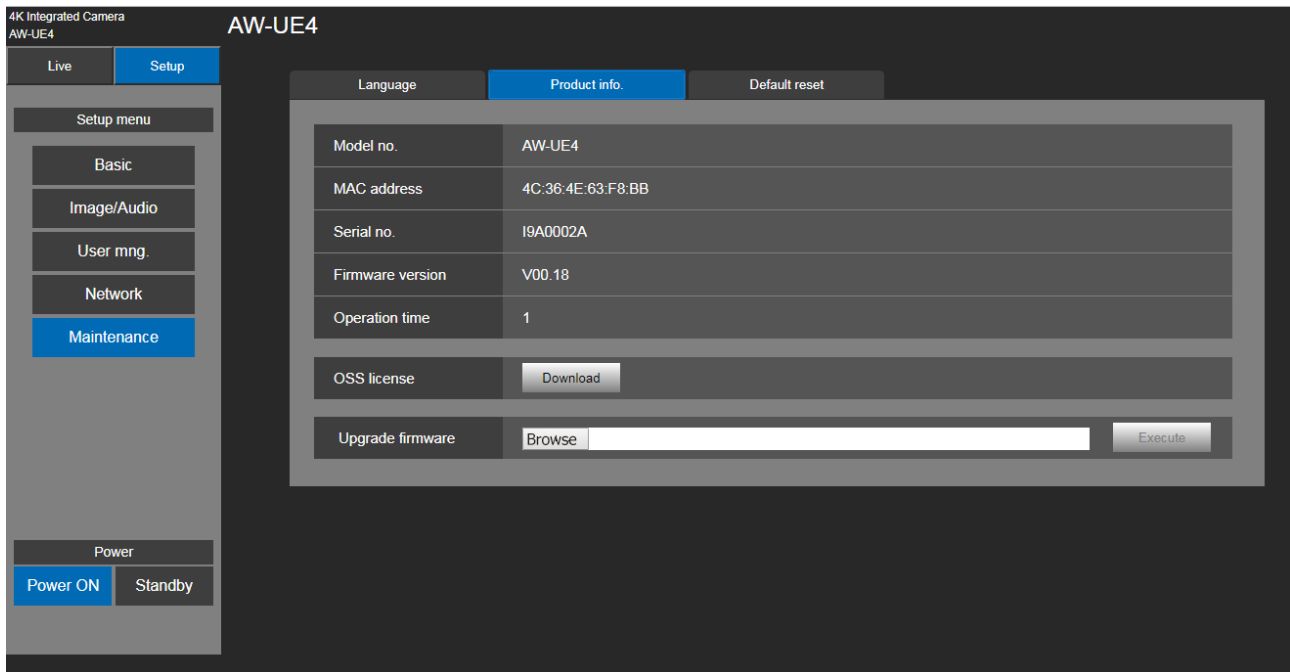

### ■ Model no.

Display the unit's model number.

### ■ MAC address

Display the unit's MAC address.

### ■ Serial no.

Display the unit's serial number.

### ■ Firmware version

Display the overall system version of the unit.

### ■ Operation time

Display the hours the unit has been operating.

### ■ OSS license

Click "Download" button to download the OSS (Open Source Software) file. The OSS license file include all OSS license for AW-UE4. The download file name is "License.zip".

## Upgrading the firmware (Firmware file)

Click [Setup] > [Maintenance] > [Product Info.].



1. Download the latest software to your personal computer.

[Note]

Keep the maximum combined number of characters to be used for the name of the directory in which the software will be stored and for the name of the software which has been downloaded to less than 250 characters.

2. Click the [Browse] button, and specify the downloaded software.
3. Click the [Execute] button. The [Execute] button will be enabled when the direction of software has been select.
4. The software upgrade check screen is displayed.

After upgrading the software version, be absolutely sure to delete the temporary Internet files.

[Note]

- An upgrade progress bar appears after you click the [Execute] button, and the process will take about 2 minute.
- Use the personal computer on the same subnet as the camera to upgrade the software version.
- Before using the version upgrading software, be absolutely sure to check the precautions to be observed, and follow the instructions.
- Use the files specified by Panasonic Connect Co., Ltd. as the software used for version upgrading.
- Do not turn off the unit's power while a software version is being upgraded. (Message will appear to indicate that the process is complete.)
- While a software version is being upgraded, do not attempt to execute any other operations until the version has been upgraded.
- Close the web browser once after performing a version upgrade.
- If the power is turned off during upgrading, please upgrade once more. In the case the unit may not power on, please consult your local dealer.

## Default Reset

The unit's setting data is initialized and the unit is restarted in here.

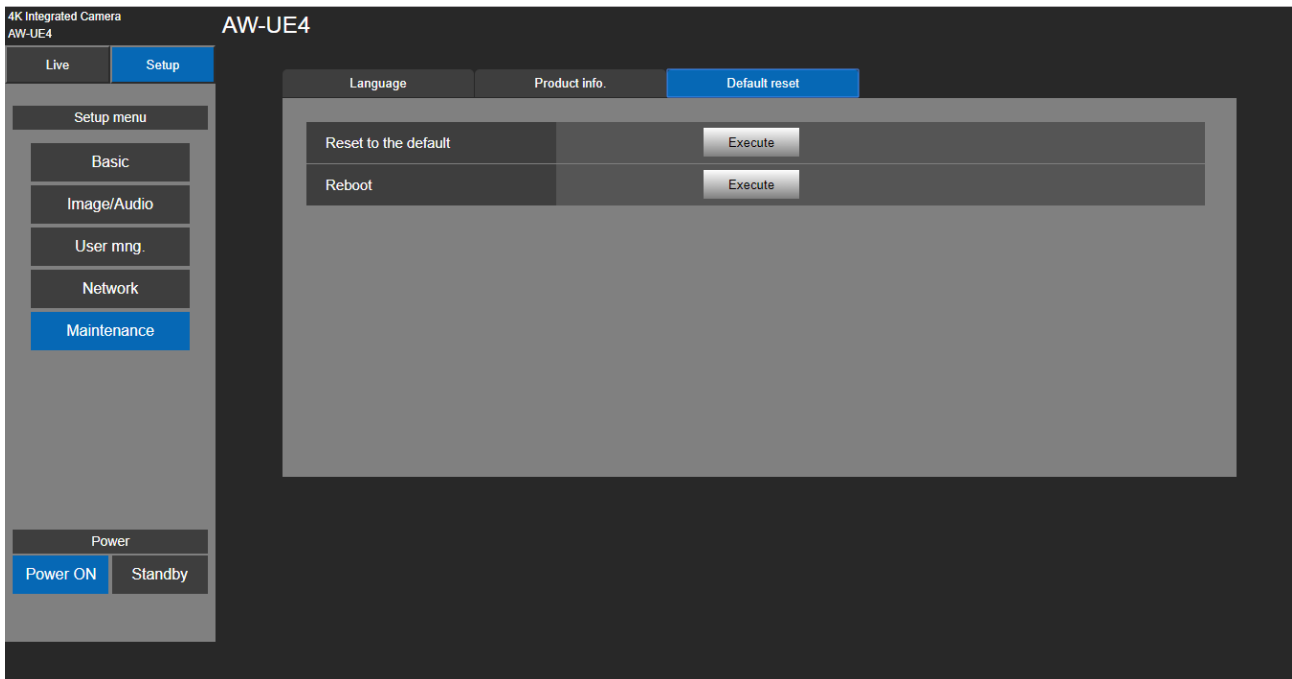

### ■ Reset to the default (Except the network settings)

When the [Execute] button is clicked, the unit's settings are returned to their defaults.

When the initialization operation is started, the unit is restarted so no operations can be undertaken for about 2 minutes.

[Note]

The following setting items will not be returned to defaults.

- [Priority Mode]
- [Frequency]
- [Format]
- All settings under [User mng.]
- All settings under [Network - Network]
- [AWB] adjustment values will not be returned to defaults.

### ■ Reboot

When the [Execute] button is clicked, the unit is rebooted.

After the unit has been rebooted, no operations can be undertaken for about 2 minutes as is the case when the unit's power is turned on.

# Web Camera Functions

---

The unit can be used as a Web camera if you connect the unit and a personal computer or other device with a commercially available USB cable.

The unit is compliant with USB Video Class and USB Audio Class. The video and audio of the unit can be transmitted to a personal computer or other device by using communication software or other software.

- Set the priority mode to "HDMI/USB", "USB", "USB(4K)" or "USB (Video Conference)" before use.
- For the connection procedure, refer to "System example 3 (USB connection)".

Audio can be output from the audio input connector [AUDIO IN] of the unit to a personal computer or other device.

[Note]

- There is no guarantee that operation will be possible with all devices that have a USB port.
- IP control, IP video transmission, and PoE power supply can be used at the same time as these functions if you use a LAN cable. However, some limitations will occur to IP video transmission compared with when the priority mode is set to "IP". For details, refer to "[Priority mode](#)" section.
- Using the USB Video with Skype for Business - set the USB Video H.264 to "Disable".

## Controllable functions

The following functions can be controlled when the unit is used as a Web camera.

- The names of the functions are the names used in Windows. Furthermore, values are shown as decimals.
- [ ] indicates the actual function names.
- Please do not change the following menu during UVC output.  
Priority mode, Frequency, Format, Install Position, Mirror, Mic

## Image adjust

[Brightness] >[Picture level]

This can be set in the same way same way as "Picture level" of the menus and Web settings.

Setting range: -4, -3, -2, -1, 0, 1, 2, 3, 4

## Chroma level [Chroma level]

This can be set in the same way same way as "Chroma level" of the menus and Web settings.

Setting range: 0 to 10

Equivalent to -3 to +3 of "Chroma Level".

If the scene mode is set to "Full Auto", even if this setting is changed, the change will not be reflected on the unit.

## White balance [White Balance mode]

This can be set in the same way same way as "White Balance mode" of the menus and Web settings.

Setting value: ATW, AWB A, AWB B, 3200K, 5600K

## Backlight compensation [Backlight Comp]

This allows you to set backlight compensation in the same way as "Back Light COMP." of the menus and Web settings.

Setting value: Off, On

If the scene mode (scene) is set to "Full Auto", even if this setting is changed, the change will not be reflected on the unit.

## Detail [Detail]

This can be set in the same way same way as "Detail" of the menus and Web settings.

Setting Range : 0, 1, 2, 3

## Contrast [Contrast]

This can be set in the same way same way as "Contrast" of the menus and Web settings.

Setting Range : 0, 1, 2, 3, 4

## Zoom [Zoom]

Zoom magnification can be changed.

Setting Range : 1 ~ 60



**Pan [Pan]**

The crop position can be changed during Zoom.

Setting Range : -720 ~ 720

**Tilt [Tilt]**

The crop position can be changed during Zoom.

Setting Range : -405 ~ 405

# Troubleshooting

## Operation

Symptom	Cause and solution
No power	Is the network cable for the PoE (IEEE802.3af) compatible power supply device and the unit connected properly?
	Power may not be supplied if the total power limit is exceeded on power supply devices that allow connections to multiple PoE terminals.
	If the unit is connected to the controller, has it been connected properly? → For details, refer to the operating instructions for the controller.
Cannot operate (common to wireless remote control, controller)	Is the power on? → If the unit's status display lamp is off or lights up orange, it means that the unit's power is not on.
	Has the unit you want to operate been selected properly?
Cannot operate using the wireless remote control	Have the remote control's batteries run down or have the batteries been installed with their polarities reversed? → If the status display lamp does not blink even when the wireless remote control is operated near the wireless remote control signal light-sensing area, it means that the batteries have run down. Replace the batteries.
	Have the Wireless ID been set correctly?
	Is there a fluorescent light or plasma monitor near the unit and, if so, is the wireless remote control signal light-sensing area exposed to its light?
	Is the wireless control on the web screen menu not set to "Off"? → If the power status indicator flashes orange rapidly (5Hz) when operated with the wireless remote control, the wireless control in the Web screen menu is set to "Off".
The unit turns in the opposite direction to the one operated	Has the Install Position setting been selected correctly?
	The reversal setting may have been established at the controller if the unit is connected to the controller. → For details, refer to the operating instructions for the controller.
Cannot operate using the controller	Is the unit connected to the controller properly? → For details, refer to the operating instructions for the controller.
	It may be necessary to upgrade the version of the controller so that the controller will support the unit. → For details on upgrading, visit the support page on the following website. <a href="https://pro-av.panasonic.net/">https://pro-av.panasonic.net/</a>
Cannot access from a web browser	Has a LAN cable of category 5e or above been connected to the LAN connector for IP control <LAN LINK/ACT>?
	Is the [LINK] LED of the LAN connector for IP control lit? → If it is not lit, it means that something is wrong with the connection to the LAN or that the network at the connection destination is not working properly. Check the LAN cable for defective contacts, and check the wiring.
	Is the power on? → If the unit's status display lamp is off or lights up orange, it means that the unit's power is not on.

Symptom	Cause and solution
<p><b>Cannot access from a web browser</b></p>	<p><b>Has a valid IP address been set in the unit?</b></p>
	<p><b>Has the wrong IP address been accessed?</b>  → Check the connections by following the steps below.  <b>For Windows:</b>  Using the Windows command prompt, execute  &gt; ping [IP address which has been set in the camera]  A reply returned from the unit signifies that there are no problems in operation.  If a reply is not received, try following operation:  Reboot the unit, and within 20 minutes change the IP address using the Easy IP Setup Software.  <b>For Mac:</b>  Using the OS X terminal, execute  &gt; ping -c 10 [IP address which has been set in the camera]  A reply returned from the unit signifies that there are no problems in operation.  If a reply is not received, try following operation:  Reboot the unit, and within 20 minutes change the IP address using the Easy IP Setup Software.</p>
	<p><b>Is the same IP address setting being used by another unit?</b>  → Check out the IP addresses of the unit, access devices (personal computer, etc.) and any other cameras.</p>
	<p><b>Does the subnet mask setting match the network subnet of the connection destination?</b>  → Check out the subnet mask settings of the unit and access devices, and then consult with the network administrator.</p>
	<p><b>Has the “Use a proxy server” setting been selected by the web browser? (When the unit and the personal computer are connected to the same subnet)</b>  → If a proxy server has been set using the [proxy setting] of the web browser, it is recommended that a “Don’t use proxy” address be selected as the unit’s IP address setting.</p>
	<p><b>Has the wrong default gateway been set for the unit? (When the unit and personal computer are connected to different subnets)</b>  → Check out the default gateway that has been set for the unit, and then consult with the network administrator.</p>
<p><b>When the power is supplied from the personal computer, the unit does not work</b></p>	<p><b>Reconnect the USB cable that is powered by the personal computer.</b></p>
<p><b>When the power is supplied from the personal computer, the unit does not display "USB" or "USB(4K)" in the priority mode</b></p>	<p><b>Reconnect the USB cable that is powered by the personal computer.</b></p>

## Video

Symptom	Cause and solution
No pictures are displayed or the pictures are disturbed	Has the unit been connected properly to the other connected devices?
	If the system is configured in such a way that the picture is also switched when the unit to be operated is selected, has the correct unit been selected?
	Has the image signal setting been selected correctly?
	While outputting video from HDMI, if the USB device is connected / disconnected or video is started, the HDMI output video may be disrupted. Do not disconnect the USB device while using HDMI output.
The picture is flipped vertically	Has the Install Position setting been selected correctly
Multiple color bands (color bars) are displayed	Switch to the camera picture.
The menu screen is displayed	Exit the menu.
It is difficult to view the menu screens	<p>Depending on the HDMI monitor you are using, you may experience one or more of the symptoms described below. These symptoms are especially noticeable when any of the SD formats is used: This is normal and not indicative of any trouble.</p> <ul style="list-style-type: none"> <li>● The resolution of the characters in the camera menu displays changes as the background image changes.</li> <li>● Depending on the edge enhancement setting established for the monitor, white lines appear in front of the black shadows of the menus.</li> <li>● Depending on the edge enhancement setting established for the monitor, the background colors may be superimposed onto the white parts of the menus.</li> </ul>
Something is wrong with the coloring of the pictures	Activate the ATW (Auto tracking white adjustment) function.
	<p>In some situations, the proper colors may not be reproduced using the ATW function.</p> <p>→ In cases like this, proceed with the white balance adjustment.</p>
The pictures are too light or too dark	The pictures may be dark if the analog video signal cables are too long because this will cause signal attenuation.
Using the USB Video with Skype for Business, Skype for Business stop.	Has the USB Video H.264 been selected to "Disable"?

## IP images

Symptom	Cause and solution
Images are not displayed	<p><b>For Windows:</b>            If [Check for newer versions of stored pages] is not set to [Every time I visit the webpage] in the temporary Internet file settings, IP images may not appear in the live screen [Live].            → Perform the following.            Select [Tools] - [Internet Options] in Internet Explorer.            Click the [General] tab, and click the [Settings] button under [Browsing history].            In the [Temporary Internet Files and History Settings] dialog box, select the [Every time I visit the webpage] option under [Check for newer versions of stored pages].            Click the [OK] button.</p>
The images do not update or display properly	<p><b>Perform the following to delete the temporary Internet files. For Windows:</b>            Select [Tools] - [Internet Options] in Internet Explorer.            Click the [General] tab, and click the [Delete] button under [Browsing history].            In the [Delete Browsing History] screen, select the [Temporary Internet Files] checkbox, and then click [Delete].            Click the [OK] button.</p> <p><b>For Mac:</b>            Select [Safari] - [Empty Cache] in Safari.            Click [Empty] in the [Are you sure you want to empty the cache?] pop- up screen.</p> <p><b>The unit's ports may be filtered by the firewall or other function of the anti-virus software.</b>            → Change the HTTP port number of the unit to a port number that will not be filtered.</p> <p><b>If the web browser screen stops, reload the web browser screen.</b></p>
The RTSP image transmission stop	If the RTSP image transmission stops, perform the playback operation from the playback device again.
Noise appears in the RTSP image transmission	If the color bar setting is "On" in IP (4K) mode, noise may appear in the RTSP image transmission. Set the color bar setting to "Off".

## USB

Symptom	Cause and solution
Cannot be recognized as a USB device, or image are not displayed	<p>USB drive installation takes time for the first time.</p> <p>Please make sure the priority mode is HDMI/USB, USB or USB(4K) mode.</p> <p>If the following operations are performed, this unit may not be recognized as a USB device.</p> <ol style="list-style-type: none"> <li>1. Change the priority mode with the USB cable connected</li> <li>2. Unplug the USB cable during UVC video playback</li> </ol> <p>If it is no longer recognized as a USB device, restart this unit.</p>
Skype for Business stops working when using it as a webcam in Skype for Business.	Please make sure that USB Video H.264 is set to Disable.

# Specification

---

## Power requirements:

- DC 5 V (4.75 V-5.25 V)
- DC 37 to 57 V (PoE power supply)

## Current consumption:

- 1.0 A (USB terminal power supply)
- 0.2 A (PoE power supply)

The symbols on this product (including the accessories) represent the following:

==== DC

 Indicates safety information.

## ■ GENERAL

- **Ambient operating temperature:** 0 °C to 40 °C (32 °F to 104 °F)
- **Storage temperature:** -20 °C to +50 °C (-4 °F to +122 °F)
- **Allowable humidity ranges:** 20 % to 90 % (no condensation)
- **Dimensions (W x H x D):** 123 mm x 131 mm x 139 mm  
(4-53/64 inches x 5-5/32 inches x 5-29/64 inches)  
(Excluding protrusions, ceiling mount bracket)
- **Mass (Weight):** Approx. 0.5 kg (1.1 lb.)  
(Excluding ceiling mount bracket)
- **Controller supported:** AW-RP60  
(Please upgrade the firmware version of this unit to Ver. 1.32 or above.)

## ■ OUTPUT

- **HDMI:** HDMI Type-A  
HDCP is not supported.  
VIERA Link is not supported.

## ■ INPUT/OUTPUT

- **LAN:** LAN connector for IP control (RJ45)
- **USB:** Type-C port

## ■ FUNCTIONS AND PERFORMANCE

### [Camera unit]

- **Image sensor:** 1/2.5-type MOS
- **Lens:** F2.4 (f = 2.21 mm)  
Horizontal Field of view: 111 ° (LDC OFF), 108 ° (LDC ON)  
Vertical Field of view: 75 °  
Minimum focus distance: 700 mm (2.3 ft)
- **Minimum illumination:** 4 lx (50 IRE, Gain 42 dB, Shutter 1/60)
- **Horizontal resolution:** 1400 TV line (center area)
- **Gain selection :** Auto, 0 dB to 42 dB (3 dB steps)

**[Camera unit](Continue)**

● **Shutter speed:**

- Full Auto mode Slow Shutter ON/Shutter Priority mode/Manual mode  
[60 Hz/59.94 Hz]  
1/1, 1/2, 1/5, 1/10, 1/20, 1/30, 1/60, 1/120, 1/240, 1/480, 1/1000, 1/2000, 1/4000, 1/8000, 1/16000
- [50 Hz]  
1/1, 1/2, 1/5, 1/10, 1/20, 1/25, 1/50, 1/100, 1/250, 1/500, 1/1000, 1/2000, 1/4000, 1/8000, 1/16000
- Full Auto mode Slow Shutter OFF  
[60 Hz/59.94 Hz]  
1/60, 1/120, 1/240, 1/480, 1/1000, 1/2000, 1/4000, 1/8000, 1/16000
- [50 Hz]  
1/50, 1/100, 1/250, 1/500, 1/1000, 1/2000, 1/4000, 1/8000, 1/16000

● **Zoom:** 4x Digital Zoom

● **Pan/tilt angle:**

- ±34 °/±21 ° (Digital Zoom 2x)
- ±45 °/±30 ° (Digital Zoom 4x)

● **White balance adjustment:** ATW, AWB A, AWB B, 3200 K, 5600 K

● **Chroma amount variability :** 11 steps(0 to 10)

● **Color bars :** [59.94 Hz/60 Hz] : SMPTE

[50 Hz] : FULL

● **Scene:** Full Auto, Shutter Priority, Manual

● **Microphone:** Stereo microphone

● **HDMI output format:**

System frequency 59.94 Hz	System frequency 60 Hz	System frequency 50 Hz
2160/29.97p	2160/30p	2160/25p
1080/59.94p	1080/60p	1080/50p
1080/29.97p	1080/30p	1080/25p
720/59.94p	720/60p	720/50p

**[USB connection]**

Supported devices: Equipped with USB2.0 compatible port.

- **Video output:** USB Video Class Ver1.1
- **Video output format:** H.264<sup>\*1</sup>, Motion JPEG, YUV(no compression).  
\*1: Please upgrade the firmware version of this unit to Ver. 1.32 or above.
- **Audio output:** USB Audio Class Ver1.0
- **Audio compression format:** Linear PCM, 48 kHz, 16-bit, 2 channels

● **Resolution/Frame rate**

Image	Resolution	Frame rate*1	
		System frequency 59.94 Hz/60 Hz	System frequency 50 Hz
H.264	3840x2160	30 fps	25 fps
		15 fps	10 fps
		5 fps	5 fps
	1920x1080	60 fps	50 fps
	1280x720	30 fps	25 fps
	640x360	15 fps	10 fps
		5 fps	5 fps
Motion JPEG	3840x2160	5 fps	5 fps
	1920x1080	30 fps	25 fps
	1280x720	15 fps	10 fps
	640x360	5 fps	5 fps
YUV	640x360	15 fps*2	10 fps*3

\*1: The frame rate may be lower than the setting depending on the operating conditions.

\*2: When "Priority Mode" is set to "USB (Video Conference)", the frame rate will be 30 fps.

\*3: When "Priority Mode" is set to "USB (Video Conference)", the frame rate will be 25 fps.

**[IP streaming]**

Video compression format: Motion JPEG, H.264, H.265.

● **Transfer mode**

Image	Resolution	Frame rate*1	
		System frequency 59.94 Hz/60 Hz	System frequency 50 Hz
Motion JPEG	1280x720	10 fps	10 fps
	640x360	30 fps 10 fps	25 fps 10 fps
H.264/H.265	3840x2160	30 fps	25 fps
		15 fps	10 fps
		5 fps	5 fps
	1920x1080	60 fps	50 fps
	1280x720	30 fps	25 fps
	640x360	15 fps 5 fps	10 fps 5 fps

\*1: The frame rate may be lower than the setting depending on the operating conditions.

● **Audio compression mode**

Audio compression format: AAC-LC, 48 kHz, 16 bit, 2 channels.

● **Supported protocol**

IPv4	TCP/IP, UDP/IP, HTTP, RTSP, RTP, RTP/RTCP, DHCP, DNS, ICMP, ARP, RTMP, RTMPS
IPv6	TCP/IP, UDP/IP, HTTP, RTSP, RTP, RTP/RTCP, DNS, ICMPv6



# Index

---

<b>1</b>	
1/2.5" .....	10
<b>3</b>	
3200K.....	62
<b>5</b>	
5600K.....	34, 62
<b>A</b>	
Abbreviations .....	2
Access level .....	69
Accessories.....	11
Advanced operations .....	32
AGC Max Gain.....	39, 49, 62
Ambient operating temperature .....	83
ARP.....	85
ATW .....	34, 62
Audio .....	59
Audio compression .....	84, 85
Audio output.....	84
Authentication .....	68
AWB.....	33
AWB A.....	33, 62
AWB B.....	33, 62
<b>B</b>	
Back Light COMP .....	41, 49, 63
Backlight compensation.....	77
Basic Settings .....	57
<b>C</b>	
Camera .....	37
Camera head .....	14
Camera Menu .....	35, 37, 49
Camera Title.....	58
Characteristics .....	10
Chroma Level.....	40, 49, 62, 77
<b>Codec</b> .....	59
Color Bar .....	46, 50, 67, 84
Contrast .....	41, 49, 63, 77
<b>D</b>	
Default gateway .....	48, 50, 71
Default reset.....	76
Detail .....	40, 49, 63, 77
DHCP .....	70
Digital zoom .....	45, 50, 66
Dimensions .....	83
DNR .....	41, 49, 63
DNS.....	71
Drop-prevention wire.....	11
DRS.....	41, 49, 63
<b>E</b>	
Easy IP setup Software.....	12, 19
<b>F</b>	
Format.....	44, 65
Frame rate .....	60, 85
Frequency .....	43, 49, 66
Full Auto .....	38, 49, 61
FW Version .....	47
<b>G</b>	
Gain.....	40, 49, 62, 83
<b>H</b>	
H.264.....	59, 85
H.265.....	59, 85
HDMI .....	24, 42, 57
HDMI terminal .....	14
HDMI(4K) .....	24, 42, 57
Humidity ranges .....	83
<b>I</b>	
Image .....	59, 61, 77, 85
Image capture size.....	59
Image display .....	8
Image sensor .....	83
Initial Account.....	21
Initialize .....	48, 50
Install Position.....	44, 50, 66

<b>I</b>		<b>O</b>	
Internal microphone .....	14	Operating Precautions .....	12
IP Address .....	47, 50, 70, 71	Operating temperature .....	12
IP control .....	10	Operation time .....	74
IP image .....	82	Operations Table .....	35
IP image output functions .....	10	Optional Accessories .....	11
IP Network .....	50	OSD .....	46, 66
IP(4K) .....	24, 42, 57	OSD Menu .....	54
IPv4 .....	70, 85	OSD off with Tally .....	50
IPv6 .....	71, 85	OSS license .....	74
<b>J</b>		Output .....	65, 83
JPEG .....	59, 85	<b>P</b>	
<b>L</b>		Pan .....	78, 84
LAN .....	83	Panning .....	15
LAN connector .....	14	Password .....	69
LAN indicator .....	14	Picture level .....	39, 49, 61
Language .....	47, 50, 73	PoE .....	10, 12
LDC .....	41, 49	PoE power supply .....	10, 12
Len .....	14, 83	Power .....	54
Live Page .....	58	Power off .....	23
L-Mount kit .....	11	Power on .....	23
<b>M</b>		Power status indicator .....	14
MAC Address .....	48, 50, 74	Preset .....	55
Main Menu .....	37	Preset Memories .....	32
Maintenance .....	37, 47, 73	Preset Position .....	64
Manual .....	38, 61	Primary server address .....	71
Max bit rate .....	60	Priority mode .....	24, 42, 49, 57
Memory .....	8	Product Info .....	74
Mic .....	46, 50, 67	Protocol .....	85
Microphone .....	84	<b>R</b>	
Mirror .....	45, 66	Reboot .....	76
Model no. ....	74	Remote control ID .....	14
Mount kit .....	11	Resolution .....	85
<b>N</b>		RTMP .....	54, 72, 85
Network .....	70, 85	RTMPS .....	85
Network security .....	9	<b>S</b>	
Network setting .....	19, 70	Scene .....	38, 49, 84
		Scene mode .....	28
		Secondary server address .....	71

## S

Serial no. ....	74
Setup screen .....	56
Shooting operation .....	22
Shutter priority .....	38, 49, 61
Shutter speed .....	39, 49, 62, 84
Slow shutter .....	39, 49, 62
Specification .....	83
Storage temperature .....	83
Stream key .....	72
Stream transmission .....	59
Subnet mask .....	48, 50, 70
System .....	37, 42, 65

## T

Tally .....	45, 46, 50, 66
Tally status indicator .....	14
Tilt .....	84
Tilt .....	78
Tilting .....	15
Transfer mode .....	85
Tripod screw .....	11
Troubleshooting .....	79

## U

URL .....	72
Usage restrictions .....	9
USB .....	24, 42, 57, 82, 83
USB cable .....	10, 11, 14

## U

USB connection .....	84
USB terminal .....	14
USB(4K) .....	24, 42, 57
User authentication .....	68
User check .....	69
User management .....	68
User name .....	69

## V

Video .....	81
Video output .....	84
Video over IP .....	59

## W

Web live screen .....	54
Web screen .....	51
Web screen configuration .....	56
Weight .....	83
White balance .....	33, 40, 62, 77, 84
White balance mode .....	49
Wirelee ID .....	67
Wireless Control .....	67
Wireless ID .....	45, 50
Wireless Remote Control .....	16

## Z

Zoom .....	55, 77, 84
Zoom In/Out .....	30
Zoom speed .....	30

**Panasonic Connect Co., Ltd.**

Web Site: <https://pro-av.panasonic.net/en/>

© Panasonic Connect Co., Ltd. 2019-2022