

Panasonic®

Operating Instructions

4K Integrated Camera

Model No. **AW-UE150WP**

Model No. **AW-UE150KP**

Model No. **AW-UE150WE**

Model No. **AW-UE150KE**

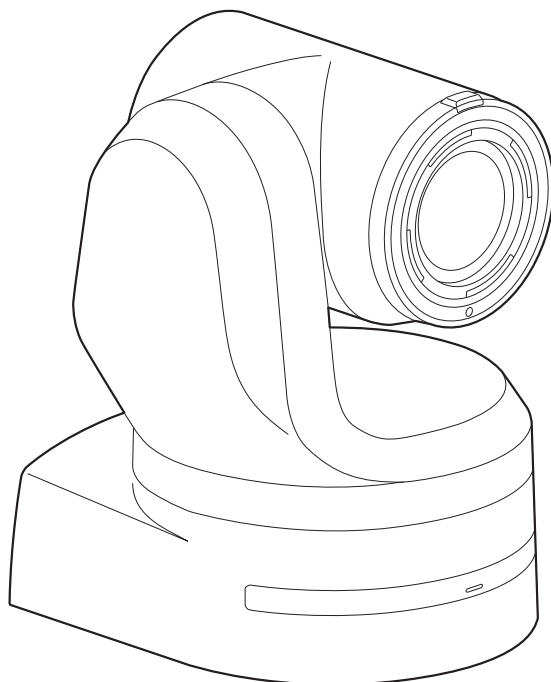

HEVC Advance™
Covered by patents at patentlist.accessadvance.com

HDMI™

Before operating this product, please read the instructions carefully and save this manual for future use. Please carefully read the "Read this first!" (pages 2 to 5) of this Manual before use.

Read this first! (For AW-UE150WP, AW-UE150KP)

WARNING:

- To reduce the risk of fire or electric shock, do not expose this equipment to rain or moisture.
- To reduce the risk of fire or electric shock, keep this equipment away from all liquids. Use and store only in locations which are not exposed to the risk of dripping or splashing liquids, and do not place any liquid containers on top of the equipment.

WARNING:

Always keep the main unit mounting screw, bracket mounting screws and drop-prevention wire mounting screw out of the reach of infants and small children.

CAUTION:

Do not remove panel covers by unscrewing.
To reduce the risk of electric shock, do not remove the covers.
No user serviceable parts inside.
Refer servicing to qualified service personnel.

CAUTION:

In order to maintain adequate ventilation, do not install or place this unit in a bookcase, built-in cabinet or any other confined space. To prevent risk of electric shock or fire hazard due to overheating, ensure that curtains and any other materials do not obstruct the ventilation.

CAUTION:

To reduce the risk of fire or electric shock and annoying interference, use the recommended accessories only.

CAUTION:

Check the installation at least once a year.
An improper installation could cause the unit to fall off resulting in personal injury.

CAUTION:

Do not pick up and move the unit while the tripod is attached.
The fitting may break under the weight of the tripod, which may result in injury.

 indicates safety information.

FCC NOTICE (USA)

Supplier's Declaration of Conformity

Model Number: AW-UE150WP/AW-UE150KP

Trade Name: Panasonic

Responsible Party: Panasonic Corporation of North America

Two Riverfront Plaza, Newark, NJ 07102

Support contact: 1-800-524-1448

This device complies with part 15 of the FCC Rules.

Operation is subject to the following two conditions:

(1) This device may not cause harmful interference, and (2) this device must accept any interference received, including interference that may cause undesired operation.

CAUTION:

This equipment has been tested and found to comply with the limits for a class A digital device, pursuant to Part 15 of the FCC Rules. These limits are designed to provide reasonable protection against harmful interference when the equipment is operated in a commercial environment. This equipment generates, uses, and can radiate radio frequency energy and, if not installed and used in accordance with the instruction manual, may cause harmful interference to radio communications.
Operation of this equipment in a residential area is likely to cause harmful interference in which case the user will be required to correct the interference at his own expense.

FCC Warning:

To assure continued FCC emission limit compliance, follow the attached installation instructions and the user must use only shielded interface cables when connecting to host computer or peripheral devices. Also, any unauthorized changes or modifications to this equipment could void the user's authority to operate this device.

NOTIFICATION (Canada)

CAN ICES-003 (A)/NMB-003(A)

 indicates safety information.

Read this first! (For AW-UE150WE, AW-UE150KE)

WARNING:

- To reduce the risk of fire or electric shock, do not expose this equipment to rain or moisture.
- To reduce the risk of fire or electric shock, keep this equipment away from all liquids. Use and store only in locations which are not exposed to the risk of dripping or splashing liquids, and do not place any liquid containers on top of the equipment.

WARNING:

Always keep the main unit mounting screw, bracket mounting screws and drop-prevention wire mounting screw out of the reach of infants and small children.

WARNING:

This equipment is compliant with Class A of CISPR 32. In a residential environment this equipment may cause radio interference.

CAUTION:

Do not remove panel covers by unscrewing.
To reduce the risk of electric shock, do not remove the covers.
No user serviceable parts inside.
Refer servicing to qualified service personnel.

CAUTION:

In order to maintain adequate ventilation, do not install or place this unit in a bookcase, built-in cabinet or any other confined space. To prevent risk of electric shock or fire hazard due to overheating, ensure that curtains and any other materials do not obstruct the ventilation.

CAUTION:

To reduce the risk of fire or electric shock and annoying interference, use the recommended accessories only.

CAUTION:

Check the installation at least once a year.
An improper installation could cause the unit to fall off resulting in personal injury.

CAUTION:

Do not pick up and move the unit while the tripod is attached.
The fitting may break under the weight of the tripod, which may result in injury.

 indicates safety information.

Turkey Only

AEEE Yönetmeliğine Uygundur.
AEEE Complies with Directive of Turkey.

EMC NOTICE FOR THE PURCHASER/USER OF THE APPARATUS

1. Pre-requisite conditions to achieving compliance with the above standards

<1> Peripheral equipment to be connected to the apparatus and special connecting cables

- The purchaser/user is urged to use only equipment which has been recommended by us as peripheral equipment to be connected to the apparatus.
- The purchaser/user is urged to use only the connecting cables described below.

<2> For the connecting cables, use shielded cables which suit the intended purpose of the apparatus.

- Video signal connecting cables
Use double shielded coaxial cables, which are designed for 75-ohm type high-frequency applications, for SDI (Serial Digital Interface). Coaxial cables, which are designed for 75-ohm type high-frequency applications, are recommended for analog video signals.
- Audio signal connecting cables
If your apparatus supports AES/EBU serial digital audio signals, use cables designed for AES/EBU.
Use shielded cables, which provide quality performance for high-frequency transmission applications, for analog audio signals.
- Other connecting cables (IEEE1394, USB)
Use double shielded cables, which provide quality performance for high-frequency applications, as connecting cables.
- When connecting to the DVI signal terminal, use a cable with a ferrite core.
- If your apparatus is supplied with ferrite core(s), they must be attached on cable(s) following instructions in this manual.

2. Performance level

The performance level of the apparatus is equivalent to or better than the performance level required by these standards.

However, the apparatus may be adversely affected by interference if it is being used in an EMC environment, such as an area where strong electromagnetic fields are generated (by the presence of signal transmission towers, cellular phones, etc.). In order to minimize the adverse effects of the interference on the apparatus in cases like this, it is recommended that the following steps be taken with the apparatus being affected and with its operating environment:

1. Place the apparatus at a distance from the source of the interference.
2. Change the direction of the apparatus.
3. Change the connection method used for the apparatus.
4. Connect the apparatus to another power outlet where the power is not shared by any other appliances.



Disposal of Old Equipment

Only for European Union and countries with recycling systems

This symbol on the products, packaging, and/or accompanying documents means that used electrical and electronic products must not be mixed with general household waste.

For proper treatment, recovery and recycling of old products, please take them to applicable collection points in accordance with your national legislation.

By disposing of them correctly, you will help to save valuable resources and prevent any potential negative effects on human health and the environment. For more information about collection and recycling, please contact your local municipality, dealer or supplier. Penalties may be applicable for incorrect disposal of this waste, in accordance with national legislation.

Інформація для покупця

Виробник:	Panasonic Connect Co., Ltd.	Панасонік Коннект Ко., Лтд.
Адреса виробника:	Fukuoka, Japan	Фукуока Японія
Країна походження:	Japan/China	Японія/Китай

Імпортер:	ТОВ "ПАНАСОНІК УКРАЇНА ЛТД"
Адреса імпортера:	вул. Васильківська, буд. 30, м. Київ 03022, Україна

Примітки:

Термін служби виробу	7 років
----------------------	---------

Дата виготовлення може бути визначена за допомогою комбінації літер та цифр серійного номера, розташованого на продукті.

Приклад: X X XXXXXXX

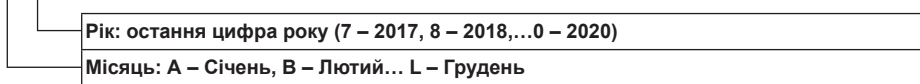

Manufactured by:

Panasonic Connect Co., Ltd.
4-1-62 Minoshima, Hakata-ku, Fukuoka 812-8531, Japan

Importer:

Panasonic Connect Europe GmbH
Authorized Representative in EU:
Panasonic Testing Centre
Winsbergring 15, 22525 Hamburg, Germany

Importer for UK:

Panasonic Connect UK,
a branch of Panasonic Connect Europe GmbH,
Maxis 2, Western Road, Bracknell, Berkshire, RG12 1RT



Read this first!

Note on grounding

- Ground the unit via the <SIGNAL GND> ground connector.

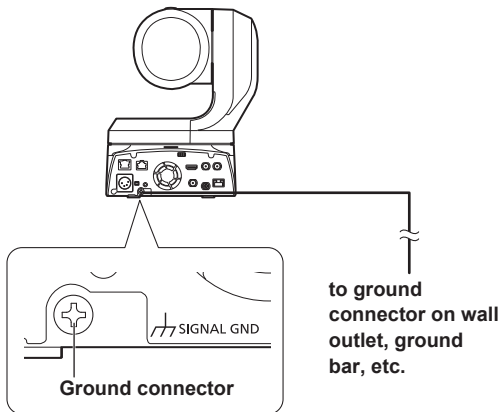

■ Trademarks and registered trademarks

- Microsoft®, Windows®, Windows® 7, Windows® 10, Microsoft Edge, Internet Explorer®, ActiveX® and DirectX® are either registered trademarks or trademarks of Microsoft Corporation in the United States and other countries.
- Apple, Mac, macOS, OS X, iPhone, iPad, and Safari are registered trademarks of Apple Inc., in the United States and other countries.
- Android™ and Chrome™ browser are trademarks of Google LLC.
- Intel® and Intel® Core™ are trademarks or registered trademarks of Intel Corporation in the United States and other countries.
- Adobe® and Reader® are either registered trademarks or trademarks of Adobe Systems Incorporated in the United States and/or other countries.
- The terms HDMI and HDMI High-Definition Multimedia Interface, and the HDMI Logo are trademarks or registered trademarks of HDMI Licensing Administrator, Inc. in the United States and other countries.
- NDI® is a registered trademark of NewTek, Inc.
- Other names of companies and products contained in these Operating Instructions may be trademarks or registered trademarks of their respective owners.

■ About copyright and licence

Distributing, copying, disassembling, reverse compiling, reverse engineering, and also exporting in violation of export laws of the software provided with this unit are expressly prohibited.

■ Abbreviations

The following abbreviations are used in this manual.

- Microsoft® Windows® 7 Professional SP1 32/64-bit is abbreviated to “Windows 7”.
- Windows® Internet Explorer® 11 32/64-bit is abbreviated to “Internet Explorer”.

For the purposes of this manual, the model numbers of the units are given as listed in the table below.

Model number of unit	Model number given in manual
AW-UE150WP	AW-UE150
AW-UE150KP	
AW-UE150WE	
AW-UE150KE	
AW-RP150G	AW-RP150

■ Illustrations and screen displays featured in the manual

- What is shown in the manual's illustrations and screen displays may differ from how it is actually appears.
- Functions which can be used by Windows Internet Explorer 11 only are indicated using the [Windows I.E.11](#) mark.
- The screenshots are used in accordance with the guidelines of Microsoft Corporation.

Contents

Read this first! (For AW-UE150WP, AW-UE150KP)	2
Read this first! (For AW-UE150WE, AW-UE150KE)	3
Read this first!	6
Note on grounding	6
Before use	8
Overview	8
Computer requirements	8
Disclaimer of warranty	9
Network security	9
Features	10
Accessories	11
Optional accessories	11
Operating precautions	12
Wireless remote control (optional accessory)	14
Parts and their functions	15
Camera unit	15
Wireless remote control: AW-RM50G (optional accessory)	25
Setting the remote control IDs	27
Network settings	28
Using Easy IP Setup Software to make settings for the unit	28
Using EasyIP Setup Tool Plus to make settings for the unit	28
Setting the initial account	29
Installing the plug-in viewer software	29
Basic shooting operations	30
How to turn the power on and off	31
Turning the power on	31
Turning the power off	31
Selecting the units	32
Selecting the shooting modes (scene files)	33
Types of shooting modes	33
How to select the shooting mode	33
Shooting	34
What to do when encountering problems in the basic shooting operations	35
More advanced operations	36
Manual shooting	37
Manually adjusting the focus	37
Manually adjusting the iris	37
Manually adjusting the shutter speed	37
Manually adjusting the gain	37
Preset memories	38
White balance adjustment	39
Automatic adjustment (AWB: AWB A or AWB B)	39
Auto tracking white adjustment (ATW)	40
3200K and 5600K presets	40
VAR	40
Black balance adjustment	41
Automatic adjustment	41
Black level (master pedestal) adjustment	42
Genlock adjustment	43
Horizontal phase adjustment	43
Basic setup operations	44
When performing the operations using the wireless remote control	44
Camera menu items	45
Setting the camera menu items	45
Top Menu screen	45
Camera screen	46
Brightness 1/2 screen	46
Brightness 2/2 screen	47
Picture 1/8 screen	48
Color TEMP. Setting screen	49
Picture 2/8 screen	50
Picture 3/8 screen	50
Picture 4/8 screen	51
Picture 5/8 screen	51
Picture 6/8 screen	52
Picture 7/8 screen	53
Picture 8/8 screen	54
Matrix 1/5 screen	54
Matrix 2/5 screen	55
Matrix 3/5 screen	55
Matrix 4/5 screen	56
Matrix 5/5 screen	56
Lens screen	57
System 1/2 screen	57
System 2/2 screen	58
Output 1/9 screen	63
Output 2/9 screen	64
Output 3/9 screen	65
Output 4/9 screen	66
Output 5/9 screen	67
Output 6/9 screen	67
Output 7/9 screen	68
Output 8/9 screen	68
Output 9/9 screen	69
Pan/Tilt screen	71
Preset 1/2 screen	72
Preset 2/2 screen	73
Maintenance screen	74
Firmware Version 1/2 screen	74
Firmware Version 2/2 screen	75
IP Network screen	75
Hour Meter screen	76
HDMI Status screen	77
Error Status screen	78
Camera menu item table	79
Displaying the web screen	86
Displaying the web screen using a personal computer	86
Switching between the Live screen [Live] and Web setup screen [Setup]	88
Logging into the Web screen	88
Web screen operations	89
Live screen [Live]	89
Web screen configurations	94
Web setup screen [Setup]	94
Setting status screen [Setting status]	95
Basic screen [Basic]	96
Image screen [Image/Audio]	104
Collaboration capability [Linkage]	127
User management screen [User mng.]	130
Network setup screen [Network]	132
Maintenance screen [Maintenance]	148
Displaying the web screen using a personal computer equipped with a touch panel	152
Displaying the web screen using a mobile terminal	154
Camera control screen [Camera Control]	154
Limiters	156
Setting/releasing the limiters	157
Basic limiter operations	157
Setting the limiters	157
Releasing the limiters	157
Resetting the limiters	157
Safe mode	158
Concerning the safe mode	158
Detection of equipment trouble	158
Troubleshooting	159
Specifications	168
Index	170

Before use

Overview

- This product is an all-in-one pan-tilt head remote camera that supports 4K/12G-SDI and is also compatible with 4K/60p format.
- Equipped with an optical 20x zoom lens and 4K-compatible MOS sensor, it is possible to record high-quality images with a high degree of realism with the horizontal resolution of 2000 lines. With its high sensitivity and built-in image-shake correction and night-mode functions, the unit can record in a wide range of environments.
- This product is compatible with NDI|HX version 2 technology of NewTek, Inc.
- The unit supports transmission of video to NewTek NDI|HX compatible software applications and hardware devices over a network.
- When a controller is connected, camera operations can be performed smoothly via IP control or serial control.
- The unit features a night mode that exposes subjects to infrared rays, making it possible to shoot even under low-light conditions.
- When the unit is connected to a personal computer via an IP network, it can be operated via a web browser.
- With a variety of 4K interfaces, there are individual outputs for HD and SDI, so the unit can be used flexibly in a wide range of situations as a 4K-compatible remote camera.
- Connection with a Panasonic camera controller is also possible via Panasonic's proprietary serial communication format.
- The unit is available in white (AW-UE150WP/AW-UE150WE) or black (AW-UE150KP/AW-UE150KE) to suit your intended application and environment.

Computer requirements

CPU	7th Generation Intel® Core™ (Kaby Lake or later) recommended
Memory	For Windows: 4 GB or more For Mac: 4 GB or more
Network function	100BASE-T/TX or 1000BASE-T, RJ-45 connector
Image display	Resolution: 1920 × 1080 pixels or more Color generation: True Color 24-bit or more
Supported operating systems and web browsers	For Windows: Microsoft® Windows® 7, 10 Windows® Internet Explorer® 11 64-bit/32-bit Microsoft Edge Google Chrome
	For Mac: macOS 10.13 Safari 11 macOS 10.12 Safari 11 OS X 10.11 Safari 11 Google Chrome
	For iPhone, iPad: iOS Safari
	For Android: Android OS Google Chrome
Other	Adobe® Reader® (for viewing the operating instructions available on the website)

IMPORTANT

- Failure to provide the required personal computer environment may slow down the delineation of the images on the screen, make it impossible for the web browser to work and cause other kinds of problems.

<NOTE>

- Depending on the software version of the unit, an update may be necessary.
- For the latest information on compatible operating systems and web browsers, visit the support desk at the following website.

<https://pro-av.panasonic.net/>

Disclaimer of warranty

IN NO EVENT SHALL Panasonic Connect Co., Ltd. BE LIABLE TO ANY PARTY OR ANY PERSON, EXCEPT FOR REPLACEMENT OR REASONABLE MAINTENANCE OF THE PRODUCT, FOR THE CASES, INCLUDING BUT NOT LIMITED TO BELOW:

- ① ANY DAMAGE AND LOSS, INCLUDING WITHOUT LIMITATION, DIRECT OR INDIRECT, SPECIAL, CONSEQUENTIAL OR EXEMPLARY, ARISING OUT OF OR RELATING TO THE PRODUCT;
- ② PERSONAL INJURY OR ANY DAMAGE CAUSED BY INAPPROPRIATE USE OR NEGLIGENT OPERATION OF THE USER;
- ③ UNAUTHORIZED DISASSEMBLE, REPAIR OR MODIFICATION OF THE PRODUCT BY THE USER;
- ④ INCONVENIENCE OR ANY LOSS ARISING WHEN IMAGES ARE NOT DISPLAYED, DUE TO ANY REASON OR CAUSE INCLUDING ANY FAILURE OR PROBLEM OF THE PRODUCT;
- ⑤ ANY PROBLEM, CONSEQUENTIAL INCONVENIENCE, OR LOSS OR DAMAGE, ARISING OUT OF THE SYSTEM COMBINED BY THE DEVICES OF THIRD PARTY;
- ⑥ ANY DEMANDS FOR COMPENSATION, CLAIMS, ETC. OCCASIONED BY THE INFRINGEMENT OF PRIVACY BY INDIVIDUALS OR ORGANIZATIONS WHOSE IMAGES WERE SHOT BY THE USER BECAUSE THESE IMAGES (INCLUDING THE RECORDINGS MADE) WERE MADE AVAILABLE BY THE USER BECAUSE IN THE PUBLIC DOMAIN FOR SOME REASON OR OTHER OR BECAUSE THE IMAGES ENDED UP BEING USED FOR PURPOSES OTHER THAN THE ONE DESCRIBED ABOVE;
- ⑦ LOSS OF REGISTERED DATA CAUSED BY ANY FAILURE.

Network security

As the unit intended to be used while connected to a network, the following security risks exist.

- ① Leakage or theft of information through the unit
- ② Unauthorized operation of the unit by persons with malicious intent
- ③ Interference with or stoppage of the unit by persons with malicious intent

It is your responsibility to take precautions, such as those described below, to protect yourself against the above network security risks. Panasonic does not accept any responsibility for damage of this type.

- Use the unit in a network secured by a firewall, etc.
- If the unit is connected to a network that includes personal computers, make sure that the system is not infected by computer viruses or other malicious programs (using a regularly updated antivirus program, anti-spyware program, etc.).
- Protect your network against unauthorized access by restricting users to those who log in with an authorized user name and password.
- After accessing the unit as an administrator, be sure to close all web browsers.
- Change the administrator password periodically.
- To avoid passwords that can be guessed easily by third parties, set a password of at least 8 characters in length, including at least 3 different types of characters, such as upper case, lower case, numbers, and symbols.
- Restrict access to the unit by authenticating the users, for example, to prevent setting information stored on the unit from leaking over the network.
- Do not install the unit in locations where the unit, cables, and other parts can be easily damaged or destroyed by persons with malicious intent.
- Avoid connections that use public lines.

<NOTE>

Notes on user authentication

- User authentication on the unit can be performed via digest authentication or basic authentication. If basic authentication is used without the use of a dedicated authentication device, password leaks may occur. We recommend using digest authentication or host authentication.

Usage restrictions

- We recommend connecting the unit, controller, and any computers to the same network segment. Events based on settings inherent to the network devices, for example, may occur in connections that include different segments, so be sure to perform checks prior to operation.

Features

■ Multi-format support

- You can switch between the following formats via the camera menus or a web browser.

[4K format]

2160/59.94p, 2160/50p, 2160/29.97p*1, 2160/25p*1, 2160/24p*1, 2160/23.98p*1

[HD format]

1080/59.94p, 1080/50p, 1080/29.97p*1, 1080/29.97PsF, 1080/25p*1, 1080/25PsF, 1080/23.98p*2, 1080/24p*1, 1080/23.98p*1, 1080/23.98PsF, 1080/59.94i, 1080/50i, 720/59.94p, 720/50p

*1 Native output

*2 OVER 59.94i output (your monitor may recognize the signal as 59.94i).

■ 1-type 4K MOS sensor and high-performance 20x zoom lens featured

- A newly developed 1-type 4K MOS sensor and DSP (digital signal processor) are incorporated. High-quality pictures are obtained by video processing in many different kinds of ways.
- In addition to its optical 20x zoom lens, the unit comes with a 10x digital zoom to achieve high-quality images that overflow with ambience.
- A dynamic range stretcher (DRS) function that compensates for overexposure and loss of dark detail and a digital noise reduction (DNR) function for minimizing image lag even in dark locations and shooting scenes clearly are incorporated to reproduce clean and clear images in a wide range of applications.

■ Easy operation of unit enabled by its integration with a high-performance pan-tilt head unit

- Operations at the high speed of 60°/s
- Wide rotational angles with a panning range of ±175° and a tilting range from -30° to 210°
- Quiet operation with noise levels of NC35
- Storage of up to 100 positions in the preset memory (The number of preset memories that can be used varies from one controller to another.)

■ Built-in night mode

- The unit supports infrared shooting. By exposing subjects to infrared rays, shooting under ordinarily difficult low-light conditions is possible. (Image output will be in black and white.)
- The iris will be fixed at open.

■ IP image output functions

- The unit is equipped with image compression and IP transmission LSI capabilities. Output in 4K quality at up to 60 fps.
- Operation with IP control allows for a wide range of applications, such as controlling the camera from remote locations.

■ High degree of compatibility with Panasonic's currently available controllers, enabling a flexible system to be put together

- A maximum of five units can be operated by serial control from one of Panasonic's currently available controllers (AW-RP150). The unit can also be used together with the cameras and pan-tilt head unit systems currently available from Panasonic Connect Co., Ltd. so that an existing system can be used to advantage to put together a system that is even more flexible.

<NOTE>

- It may be necessary to upgrade the version of the controllers other than AW-RP150 in order to support the unit. For details on upgrading, visit the support page on the following website. <https://pro-av.panasonic.net/>
The maximum distances between the units and controller is 1000 meters (3280 ft). (when serial control is exercised)
Use of an external device or some other means must be provided separately in order to extend the video signal connections.

■ Easy construction of systems thanks to integrated design used for pan-tilt head, camera and lens

- By integrating the camera, lens and pan-tilt head into a single unit, it is now easier to construct systems.

■ Use of easy-to-operate wireless remote control (optional accessory) is possible

- A wireless remote control capable of operating up to four units can be used.
It can easily be used to set the various functions or switch between them while viewing the menu screens.

■ Flexible camera layout enabled by simple connection and installation

- This unit features excellent connectivity and installability thanks to the IP control; a lightweight main unit, and the turn-lock mechanism, which enables the user to install it on his or her own (only when used indoors).

<NOTE>

- Bear in mind that this unit is designed to be used indoors only: It cannot be used outdoors.

■ While including a larger 4K lens and pan/tilt mechanism, the unit still has the same installation footprint as previous models.

- The unit maintains the compact installation footprint of previous models.

■ Easy connections and settings courtesy of IP control

- Up to two hundred units can be operated by IP connection from a Panasonic controller (AW-RP150). (The maximum length of the LAN cables is 100 meters (328 ft).)
- Network connection with AW-RP150 requires setup of an initial account. (→ page 29)
When an initial account is not set up, AW-RP150 can detect but cannot control this unit.

■ PoE++ *3 eliminates need for camera power configurations

- Configurations for camera's power supply are not necessary when the unit is connected to a network device that supports the PoE++ standard (IEEE 802.3bt compliant)*4.
Software authentication (LLDP) is also supported, but it may be necessary to make settings on the network device (IEEE P802.3bt compliant)*4.



<NOTE>

- If the external DC power supply and a PoE++ power supply are connected simultaneously, the external DC power supply will have priority. If the external DC power supply is disconnected while both power supplies are connected, the unit will restart automatically, and the image will be interrupted.
- Use a Category 5e cable or higher when using a PoE++ power supply. The maximum length of the cable between the power supply unit and the unit is 100 meters (328 ft). Using a cable that is lower than Category 5e may result in reduced power supply capabilities.
- *3 Power over Ethernet Plus Plus. Referred to as "PoE++" in this manual.
- *4 For details on PoE++ power supply devices for which operation has been verified, consult your local dealer.

Accessories

Check that the following accessories are present and accounted for.

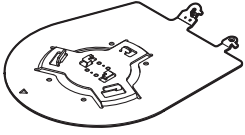
- After removing the product from its container, dispose of the power cable cap (if supplied) and packing materials in an appropriate manner.

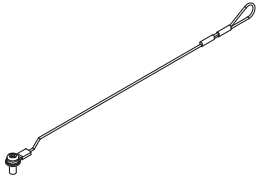
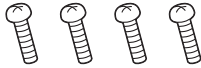
<p>Mount bracket for installation surface (Hanging/Desktop) (1)</p> 	<p>Main unit mounting screw (with flat washer, spring washer) M3×6 mm (1/4 inches) (1)</p> 
<p>Drop-prevention wire (1) Drop-prevention wire mounting screw (1) (comes attached to the unit)</p> 	<p>Bracket mounting screws (bind-head) M4×10 mm (13/32 inches) (4)</p> 

Optional accessories

- Wireless remote control AW-RM50G (Size “AA” dry battery x 2, obtained separately)
- Direct ceiling mount bracket WV-Q105A
- Fiber module

<NOTE>

- For details on optional accessories, refer to the catalog or consult your local dealer.

Operating precautions

■ Do not use the unit in oily-smoky or dusty places.

Performance may be adversely affected if small particles or other foreign objects get inside the product.

Take extra care in environments where a special effect such as theatrical smoke is used.

■ Shoot under the proper lighting conditions.

To produce pictures with eye-pleasing colors, shoot under the proper lighting conditions.

The pictures may not appear with their proper colors when shooting under fluorescent lights. Select the proper lighting as required.

■ To ensure a stable performance in the long term

Using the unit for prolonged periods in locations where the temperature and humidity levels are high will cause its parts to deteriorate, resulting in a reduction of its service life.

(Recommended temperature: Max. 35 °C (95 °F))

Ensure that a cooling unit or heating unit will not blow any air directly toward the installation location.

■ Do not point the camera at strong lights.

When parts of the MOS sensor are exposed to spotlights or other strong lights, blooming (a phenomenon where the edges of strong lights become blurred) may occur.

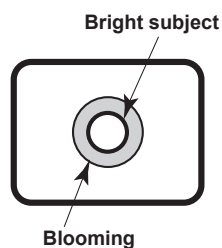

■ What happens with high-brightness subjects

Flare may occur if an extremely bright light source is pointed at the lens. In a case like this, change the angle or take some other remedial action.

■ When using the automatic functions

- In the [Scene] such as the camera menu, the initial settings on some items has been set to auto, making it impossible for these items to be operated manually. To operate them manually, switch from the auto settings to the manual settings as required.
- When using the ATW (auto tracking white adjustment) function under fluorescent lights, the white balance may vary.
- In some situations, it may be hard to focus at the auto setting. In cases like this, select the manual setting, and focus manually.

■ Zooming and focusing

When the focus is set manually, out-of-focusing may occur during zooming.

After zooming, if necessary, either adjust the focus or set the focus to auto.

When using the focus at the manual setting, proceed with zooming after setting the focus position at the Tele end where the focusing accuracy is higher. (However, if the distance from the unit to the subject is less than 1.5 meters (4.92 ft), the subject may shift out of focus at the Wide end.)

If zooming is performed to the Tele end after having adjusted the focus at the Wide end, out-of-focusing may occur.

■ Operation of the lens when the power is turned on

When the unit's power is turned on, the zoom, focus and iris are adjusted automatically.

■ The unit comes with the safe mode.

The safe mode is function designed to protect the unit from damage. For details, refer to "Concerning the safe mode" (→ page 158).

■ Operating temperature range

Avoid using the unit in cold locations where the temperature drops below 0 °C (32 °F) or hot locations where the temperature rises above 40 °C (104 °F) since these temperatures downgrade the picture quality and adversely affect the internal parts.

■ Concerning the MONI OUT signal

It is anticipated that MONI OUT is used in applications such as for outputting images to be cropped from 4K to HD and for monitoring images.

■ Concerning the HDMI interface standard

This unit has been certified as HDMI-compatible, but on rare occasions images may not be displayed depending on the HDMI device which has been connected to the unit.

■ Color bars

Color bars are used to adjust the color phase, and the widths and positions of these bars may differ from other models.

■ H.264/H.265 patent pool licensing

This product is licensed based on the AVC Patent Portfolio License, and the license does not extend beyond uses by users, who engage in the acts described below, for their own personal and non-profit applications.

- (i) Recording of image information in compliance with the AVC standard (hereafter, "AVC videos")
- (ii) Playing of AVC videos recorded by consumers engaging in personal activities or AVC videos acquired from licensed providers

For details, visit MPEG LA, LLC website (<http://www.mpegla.com>).

■ Concerning PoE++ power supply

The unit complies with the IEEE 802.3bt.

Use a compatible Ethernet hub and PoE++ injector to use a PoE++ power supply.

Software authentication (LLDP) complies with IEEE P802.3bt, but it may be necessary to make settings on the network device. For details on Ethernet hubs and PoE++ injectors for which operations have been verified, consult your local dealer.

■ Turn off the power before connecting or disconnecting the cables.

This unit is not equipped with a power switch.

Turn off the DC 12 V power supply or PoE++ power supply device before connecting or disconnecting cables.

■ Handle the unit carefully.

Do not drop the unit or subject it to strong impact or vibration.

Failure to obey may cause the unit to malfunction.

■ When the unit is not in use

Turn off the unit's power when it is not in use.

When the unit is no longer to be used, make sure to remove the camera and mount bracket rather than leaving them in place.

■ Do not touch the optical system parts.

The optical system parts are vital to the operation of the camera. Under no circumstances must they be touched. In the unlikely event that they have become dusty, remove the dust by using a camera blower or by wiping them gently with a lens cleaning paper.

■ Do not point the camera directly at the sun or a laser beam no matter whether it is turned on or not.

Taking images of the sun, laser beams, or other brightly lit subjects for prolonged periods of time may damage the CCD.

■ Personal computer used

If the same image is displayed for a prolonged period on a personal computer's monitor, the monitor may be damaged. Use of a screen saver is recommended.

■ Concerning the IP address setting

Do not run the Easy IP Setup Software on a multiple number of personal computers for a single camera and set the IP address at the same time. Otherwise, you will be unable to complete the proper procedure and set the IP address correctly.

■ Do not allow foreign matter to make contact with the rotating parts.

Failure to obey may cause the unit to malfunction.

■ Do not get close to the moving parts of the camera head.

Do not put your fingers or body close to the unit while it is in operation. Doing so may result in injury or cause the unit to malfunction. Furthermore, if the unit hits a person or obstacle, during the panning or tilting operation, the unit will enter into the safe mode. For details, refer to the page 158.

■ Keep the unit away from water.

Avoid all direct contact with water. Failure to obey may cause the unit to malfunction.

■ Maintenance

Turn off the unit's power before proceeding with maintenance. Failure to obey may result in injuries. Wipe the surfaces using a soft dry cloth. Avoid all contact with benzine, paint thinners and other volatile substances, and avoid using these substances. Otherwise, the casing may become discolored.

■ Do not turn the camera head by hand.

Turning the camera head by hand may cause the unit to malfunction.

■ Use the unit in an environment with minimal moisture and dust.

Avoid using the unit in an environment with high concentration of moisture or dust since these conditions will damage the internal parts.

■ About the lens/pan-tilt head

If the lens, pan-tilt head, and other parts are not operated for a long period of time, the viscosity of the grease applied inside them may increase and operation may become no longer possible. Move the lens and pan/tilt head regularly.

■ About consumables

The following parts are consumables. Replace them using the lifespans as a guide. The lifespans may vary depending on the operating environment and operating conditions. The lifespans are a guide for when the unit is used at 35 °C (95 °F).

- Cooling fan: Approx. 15000 hours

Contact your dealer regarding replacements.

■ Disposal of the unit

When the unit has reached the end of its service life and is to be disposed of, ask a qualified contractor to dispose of the unit properly in order to protect the environment.

■ Information on software used with this product

This product includes GNU General Public License (GPL) and GNU Lesser General Public License (LGPL) licensed software, and the customer is entitled to obtain, modify, or redistribute the source code for the software.

This product includes MIT Licensed software.

This product includes BSD Licensed software.

For details on obtaining the source codes, visit the following website.

<https://panasonic.biz/cns/sav/>

However, do not contact Panasonic for questions regarding obtained source codes.

Wireless remote control (optional accessory)

This unit can be operated by remote control using a wireless remote control (model number: AW-RM50G) purchased separately. Check out the following points before using the wireless remote control.

- Point the wireless remote control at the unit's wireless remote control signal light-sensing area (front panel or back panel), and operate it within a range of 10 meters (32.8 ft) from these areas.
- Refer to <Layout of wireless remote control signal light-sensing areas> on the right.
- The signal sensing distance is reduced if the angle at which the wireless remote control signals are sensed is increased.
The light-sensing sensitivity is reduced to about one-half when the wireless remote control is pointed at an angle of 40 degrees from each position in front of a wireless remote control signal light-sensing area (front panel or back panel).
If the remote control is operated from the behind the unit, it may be either difficult or impossible to perform the desired operations.
- If the unit is installed near fluorescent lights, plasma monitors or other such products or if the unit is exposed to sunlight, the effects of the light may make it impossible for the unit to be operated using the wireless remote control.

Be sure to follow the steps below for installation and use.

- Take steps to ensure that the wireless remote control signal light-sensing area will not be exposed to the light from fluorescent lights, plasma monitors or other such products or from the sun.
- Install the unit away from fluorescent lights, plasma monitors and other such products.
- For about 10 minutes even after the batteries have been removed from the wireless remote control, the selection of the operation to be performed (the <CAM1>, <CAM2>, <CAM3> or <CAM4> button which was pressed last) will remain stored in the memory.
When a longer period of time elapses, however, the selection is reset to the status established when the <CAM1> button was pressed.

<Layout of wireless remote control signal light-sensing areas>

<NOTE>

- The arrows in the figure below show the light-sensing directions in which the wireless remote control signals travel.

Wireless remote control signal light-sensing area (back panel, 1 place)

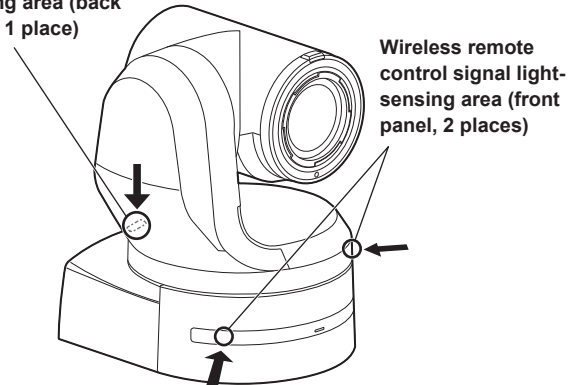

• Top view

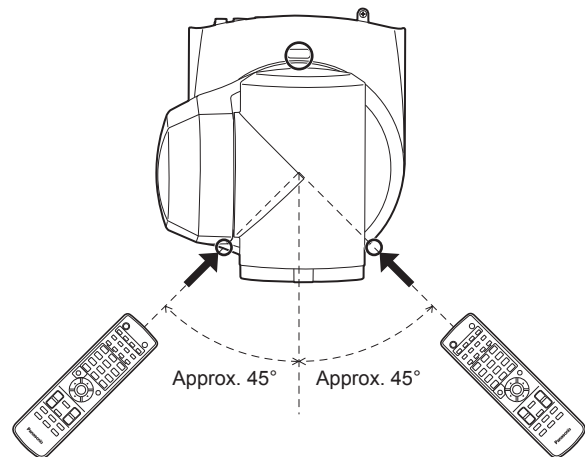

• Rear panel view

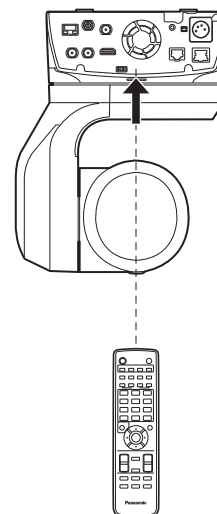

Parts and their functions

Camera unit

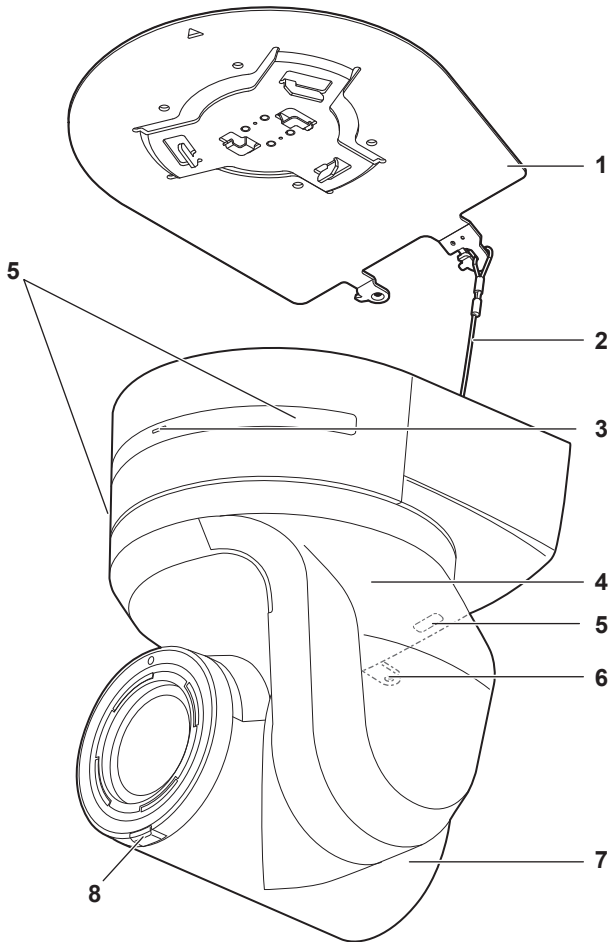

1. Mount bracket for installation surface (supplied accessory)

Mount this bracket onto the installation surface, and then attach the camera main unit to the bracket.

2. Drop-prevention wire

This wire is screwed down to the bottom panel of the camera main unit. Loop the circle part of the wire around the hook of the mount bracket.

3. Status display lamp

This lights in the following way depending on the status of the unit.

Orange	Light up	When the standby status is established
	Blink twice	When a signal not matched by the remote control ID has been received from the wireless remote control (optional accessory) while the power is on
Green	Light up	When the power is on
	Blink twice	When a signal matched by the remote control ID has been received from the wireless remote control (optional accessory) while the power is on
	Blinking rapidly	When the initialization process is complete
Red	Light up	When trouble has occurred in the unit
	Blinking slowly	Firmware being updated
	Blinking rapidly	When a PoE++ software authentication error has occurred

4. Tilt head

This rotates in the right and left direction.

5. Wireless remote control signal light-sensing area

The light-sensing area is provided in three places, on the front panel of the camera pedestal and at the top of the rear panel.

6. Hole for securing the camera pedestal

This hole is provided in the bottom panel of the camera pedestal.

7. Camera head

This rotates in the up and down direction.

8. Tally lamp

This comes on or goes off in response to the control from the controller but only when "On" has been selected as the tally lamp use setting. The tally lamp is red or green.

9. LAN connector for IP control <LAN LINK/ACT>

This LAN connector (RJ-45) is connected when exercising IP control over the unit from an external device. Use a LAN cable (category 5e or better, maximum 100 m (328 ft)) for connection.

Rear panel

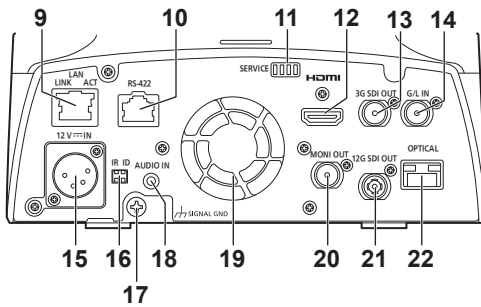

Bottom panel

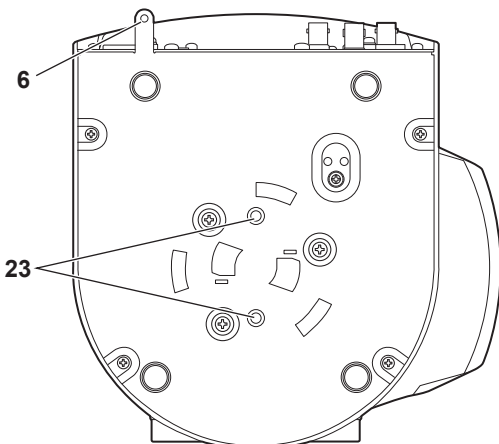

Parts and their functions (continued)

10.RS-422 connector <RS-422>

This RS-422 connector (RJ-45) is connected when exercising serial control over the unit from an external device. Use a cable with the following specifications for the connection to this connector. Furthermore, by shorting the R-TALLY signal (2-pin) with the GND (1-pin), it is possible to light the tally lamp (red) in the camera head section of the unit.

<NOTE>

- Do not connect PoE cable to the RS-422 port.
- Do not apply a voltage to the R_TALLY_IN signal pin.
- Menu settings enable the output to pin 7 and pin 8 of the red tally and green tally signals received by the unit. Output is by contact output, and normally is "OPEN", then it becomes "MAKE" for output. (→ page 68)

LAN cable*1 (category 5e or above, straight cable), max. 1000 m (3280 ft)

*1 Use of an STP (shielded twisted pair) cable is recommended.



Pin No.	Signal	Pin No.	Signal
1	GND	5	TXD+
2	R_TALLY_IN	6	RXD+
3	RXD-	7	OPTION_OUT1
4	TXD-	8	OPTION_OUT2

■ Example OPTION_OUT1, OPTION_OUT2 connector connections

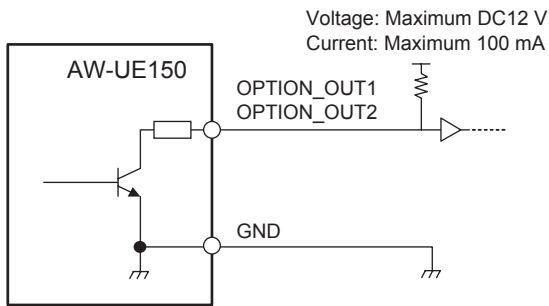

11.Service switches <SERVICE>

Perform switch settings before turning the unit on.

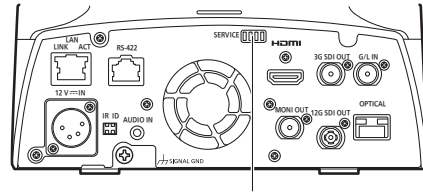

Service switches

	Function	Factory settings
SW1	Switches for initialization (Refer to the explanations in "Initialization 1" and "Initialization 2")	OFF
SW2	Always leave at OFF (used for factory adjustments)	OFF
SW3		OFF
SW4		OFF

Initialization 1

- Reset the user authentication settings and host authentication settings for network connection. (This will delete all the registered user information (IDs/passwords) and host information (IP addresses).)
- With the IR ID switches and service switches set as shown below, turn on the power of the unit.

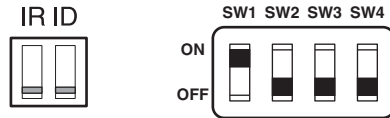

<NOTE>

- When initialization is complete, the status display lamp on the front of the unit blinks green. Set the service switches back to their original positions (SW1 to SW4 all OFF), then restart the unit.

Initialization 2

- The unit is reset to the state it was in at the time of purchase. (All camera menu setting values and network setting values are reset.)
- With the IR ID switches and service switches set as shown below, turn on the power of the unit.

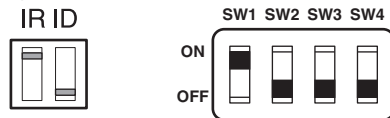

<NOTE>

- When initialization is complete, the status display lamp on the front of the unit blinks green. Set the service switches back to their original positions (SW1 to SW4 all OFF), then restart the unit.

12.HDMI connector <HDMI>

This is the HDMI video output connector.

13.3G SDI OUT connector <3G SDI OUT>

This is the 3G SDI video signal output connector.

Parts and their functions (continued)

14.G/L IN connector <G/L IN>

This is the external sync signal input connector.

This unit supports BBS (Black Burst Sync) and tri-level synchronization.

Supply to this connector the signals that correspond to the video signal format which has been set.

Frequency: 59.94 Hz, 29.97 Hz

Format	External sync signal input format		
	Tri-level sync		BBS
2160/59.94p	1080/59.94p 720/59.94p	1080/29.97p 1080/59.94i 1080/29.97PsF	480/59.94i
2160/29.97p	—	—	—
1080/59.94p	1080/59.94p 720/59.94p	—	—
1080/59.94i	—	—	—
1080/29.97p	—	—	—
1080/29.97PsF	—	—	—
1080/23.98p over 59.94i	—	—	—
720/59.94p	1080/59.94p 720/59.94p	—	—

Frequency: 50 Hz, 25 Hz

Format	External sync signal input format		
	Tri-level sync		BBS
2160/50p	1080/50p 720/50p	1080/25p 1080/50i 1080/25PsF	576/50i
2160/25p	—	—	—
1080/50p	1080/50p 720/50p	—	—
1080/50i	—	—	—
1080/25p	—	—	—
1080/25PsF	—	—	—
720/50p	1080/50p 720/50p	—	—

Frequency: 24 Hz

Format	External sync signal input format	
	Tri-level sync	
2160/24p	1080/24p	—
1080/24p	1080/24PsF	—

Frequency: 23.98 Hz

Format	External sync signal input format	
	Tri-level sync	
2160/23.98p	1080/23.98p	—
1080/23.98p	1080/23.98PsF	—
1080/23.98PsF	—	—

15.DC IN connector <12 V $\overline{\text{IN}}$ > (XLR connector)

Input 12 V DC.

<NOTE>

- Use a DC cable with the following lengths.
For 12 V input: Max. 3 m (9.84 ft) (when using an AWG16 cable)

■ External DC power supply

Connect after making sure that the output voltage of the external DC power supply is compatible with the rated voltage of the camera. Select an output amperage for the external DC power supply with a margin above the total amperage of the connected devices. The total amperage of connected devices can be calculated with the following formula.





Total power consumption ÷ voltage

When the power of the camera is turned on, inrush current is generated. Insufficient power supply when turning on the power may cause a malfunction. We recommend that you use an external DC power supply that can assure double the capacity of the total power consumption of the camera and connected devices that are turned on by interlock when the power of the camera is turned on (such as lenses, wireless microphone receivers).

- Make sure of the pin alignment of the DC output terminal of the external DC power supply and the camera DC IN connector, and connect the polarity correctly.
If the +12 V power supply is mistakenly connected to the GND terminal, it may cause fire or malfunction.

12 V $\overline{\text{IN}}$	
1	GND
2	—
3	—
4	+12 V
HA16RA-4P (77) Hirose Electric Co.	

16.IR ID switches <IR ID>

CAM1	CAM2	CAM3	CAM4
IR ID	IR ID	IR ID	IR ID
			

These are used to select the ID of the wireless remote control (optional accessory). (→ page 27)

The IR ID switch settings "CAM1" to "CAM4" correspond to the <CAM1> to <CAM4> buttons on the wireless remote control.

17.Ground connector

Connects to the ground connector on a wall outlet, ground bar, etc. for grounding. (→ page 6)

18.AUDIO IN connector <AUDIO IN>

Inputs external audio (microphone, line).

19.Ventilation holes

Blocking the ventilation holes may cause a malfunction. Make sure there is sufficient space around the ventilation holes.

20.MONITOR OUT connector <MONI OUT>

This is an SDI video signal output connector. Use it in applications such as displaying the crop position when cropping from 4K to HD and for monitoring images.

21.12G SDI OUT connector <12G SDI OUT>

This is a 12G-SDI video signal output connector.

22.Optical connector <OPTICAL>

This is the connector for the SFP+ optical fiber module. By connecting the optional fiber module, it is possible to output signals converted to optical signals from SDI signals. Select the fiber module that suits the signal band*1 for each format.

- *1 • 4K (59.94p, 50p): 12G
- 4K (other than 59.94p, 50p): 6G
- HD (59.94p, 50p): 3G
- HD (other than 59.94p, 50p): 1.5G

<NOTE>

- This unit does not support input by optical signals.

23.Tripod screw holes

(Screw: 1/4-20 UNC, ISO 1222 [6.35 mm (1/4 inches)])

Use these screw holes when securing the unit to a tripod, etc.

Parts and their functions (continued)

■ Output conditions for each video format

Frequency	System Format	HDMI	12G SDI OUT	OPTICAL	3G SDI OUT	MONI OUT
59.94Hz	2160/59.94p	2160/59.94p 1080/59.94p*1	2160/59.94p 1080/59.94p*1	2160/59.94p 1080/59.94p*1	1080/59.94p*1 1080/59.94i*1	1080/59.94i*1
	2160/29.97p	2160/29.97p 1080/29.97p	2160/29.97p 1080/29.97p 1080/29.97PsF	2160/29.97p 1080/29.97p 1080/29.97PsF	1080/29.97p 1080/29.97PsF	1080/29.97p 1080/29.97PsF
	1080/59.94p	1080/59.94p	1080/59.94p	1080/59.94p	1080/59.94p 1080/59.94i	1080/59.94i
	1080/59.94i	1080/59.94i	1080/59.94i	1080/59.94i	1080/59.94i	1080/59.94i
	1080/29.97p	1080/29.97p	1080/29.97p	1080/29.97p	1080/29.97p	1080/29.97p
	1080/29.97PsF	1080/29.97p	1080/29.97PsF	1080/29.97PsF	1080/29.97PsF	1080/29.97PsF
	1080/23.98p over 59.94i	1080/23.98p over 59.94p	1080/23.98p over 59.94i	1080/23.98p over 59.94i	1080/23.98p over 59.94i	1080/23.98p over 59.94i
720/59.94p	720/59.94p	720/59.94p	720/59.94p	720/59.94p	720/59.94p	720/59.94p
50Hz	2160/50p	2160/50p 1080/50p*2	2160/50p 1080/50p*2	2160/50p 1080/50p*2	1080/50p*2 1080/50i*2	1080/50i*2
	2160/25p	2160/25p 1080/25p	2160/25p 1080/25p 1080/25PsF	2160/25p 1080/25p 1080/25PsF	1080/25p 1080/25PsF	1080/25p 1080/25PsF
	1080/50p	1080/50p	1080/50p	1080/50p	1080/50p 1080/50i	1080/50i
	1080/50i	1080/50i	1080/50i	1080/50i	1080/50i	1080/50i
	1080/25p	1080/25p	1080/25p	1080/25p	1080/25p	1080/25p
	1080/25PsF	1080/25p	1080/25PsF	1080/25PsF	1080/25PsF	1080/25PsF
	720/50p	720/50p	720/50p	720/50p	720/50p	720/50p
24Hz	2160/24p	2160/24p 1080/24p	2160/24p 1080/24p	2160/24p 1080/24p	1080/24p	1080/24p
	1080/24p	1080/24p	1080/24p	1080/24p	1080/24p	1080/24p
23.98Hz	2160/23.98p	2160/23.98p 1080/23.98p	2160/23.98p 1080/23.98p 1080/23.98PsF	2160/23.98p 1080/23.98p 1080/23.98PsF	1080/23.98p 1080/23.98PsF	1080/23.98p 1080/23.98PsF
	1080/23.98p	1080/23.98p	1080/23.98p	1080/23.98p	1080/23.98p	1080/23.98p
	1080/23.98PsF	1080/23.98p	1080/23.98PsF	1080/23.98PsF	1080/23.98PsF	1080/23.98PsF

*1 When [UHD Crop] is [Crop(720)], output is 720/59.94p.

*2 When [UHD Crop] is [Crop(720)], output is 720/50p.

Parts and their functions (continued)

■ IP video transmission output (multi-channel display)

- When “Streaming mode” is set to “H.265”

Settings		H.265(1)	H.265(2)	H.264(1)	H.264(2)	H.264(3)	H.264(4)	JPEG(1)	JPEG(2)	JPEG(3)
Resolution		1920×1080 1280×720	1920×1080 1280×720 640×360	—	—	—	—	1920×1080 1280×720 640×360 320×180	640×360 320×180	640×360 320×180
Frame rate	System frequency 59.94Hz	60fps 30fps	60fps 30fps	—	—	—	—	30fps 15fps 5fps 1fps	30fps 15fps 5fps 1fps	30fps 15fps 5fps 1fps
	System frequency 50Hz	50fps 25fps	50fps 25fps	—	—	—	—	25fps 12.5fps 5fps 1fps	25fps 12.5fps 5fps 1fps	25fps 12.5fps 5fps 1fps
	System frequency 29.97Hz	30fps	30fps	—	—	—	—	30fps 15fps 5fps 1fps	30fps 15fps 5fps 1fps	30fps 15fps 5fps 1fps
	System frequency 25Hz	25fps	25fps	—	—	—	—	25fps 12.5fps 5fps 1fps	25fps 12.5fps 5fps 1fps	25fps 12.5fps 5fps 1fps
	System frequency 24/23.98Hz	24fps	24fps	—	—	—	—	24fps 12fps 4fps 1fps	24fps 12fps 4fps 1fps	24fps 12fps 4fps 1fps

- The H.265 transmission mode (Transmission priority) cannot be selected.
- When the system frequency is 24/23.98Hz, the resolution for H.265(1) and H.265(2) is limited to 1920×1080.
- You cannot make settings above the resolution and frame rate set by the system format.

- When “Streaming mode” is set to “H.265(UHD)”

Settings		H.265(1)	H.265(2)	H.264(1)	H.264(2)	H.264(3)	H.264(4)	JPEG(1)	JPEG(2)	JPEG(3)
Resolution		3840×2160	—	—	—	—	—	1920×1080 1280×720 640×360 320×180	640×360 320×180	640×360 320×180
Frame rate	System frequency 59.94Hz	30fps	—	—	—	—	—	30fps 15fps 5fps 1fps	30fps 15fps 5fps 1fps	30fps 15fps 5fps 1fps
	System frequency 50Hz	25fps	—	—	—	—	—	25fps 12.5fps 5fps 1fps	25fps 12.5fps 5fps 1fps	25fps 12.5fps 5fps 1fps
	System frequency 29.97Hz	30fps	—	—	—	—	—	30fps 15fps 5fps 1fps	30fps 15fps 5fps 1fps	30fps 15fps 5fps 1fps
	System frequency 25Hz	25fps	—	—	—	—	—	25fps 12.5fps 5fps 1fps	25fps 12.5fps 5fps 1fps	25fps 12.5fps 5fps 1fps
	System frequency 24/23.98Hz	24fps	—	—	—	—	—	24fps 12fps 4fps 1fps	24fps 12fps 4fps 1fps	24fps 12fps 4fps 1fps

- The H.265(UHD) transmission mode (Transmission priority) cannot be selected.

Parts and their functions (continued)

• When “Streaming mode” is set to “H.264”

Settings		H.265(1)	H.265(2)	H.264(1)	H.264(2)	H.264(3)	H.264(4)	JPEG(1)	JPEG(2)	JPEG(3)
Resolution		—	—	1920×1080 1280×720	1920×1080 1280×720 640×360 320×180	1280×720 640×360 320×180	1280×720 640×360 320×180	1920×1080 1280×720 640×360 320×180	640×360 320×180	640×360 320×180
Frame rate	System frequency 59.94Hz	—	—	60fps 30fps 15fps 5fps	60fps 30fps 15fps 5fps	30fps 15fps 5fps	30fps 15fps 5fps	30fps 15fps 5fps 1fps	30fps 15fps 5fps 1fps	30fps 15fps 5fps 1fps
	System frequency 50Hz	—	—	50fps 25fps 12.5fps 5fps	50fps 25fps 12.5fps 5fps	25fps 12.5fps 5fps	25fps 12.5fps 5fps	25fps 12.5fps 5fps 1fps	25fps 12.5fps 5fps 1fps	25fps 12.5fps 5fps 1fps
	System frequency 29.97Hz	—	—	30fps 15fps 5fps	30fps 15fps 5fps	15fps 5fps	15fps 5fps	15fps 5fps 1fps	15fps 5fps 1fps	15fps 5fps 1fps
	System frequency 25Hz	—	—	25fps 12.5fps 5fps	25fps 12.5fps 5fps	12.5fps 5fps	12.5fps 5fps	12.5fps 5fps 1fps	12.5fps 5fps 1fps	12.5fps 5fps 1fps
	System frequency 24/23.98Hz	—	—	24fps	24fps	—	—	24fps 12fps 4fps 1fps	24fps 12fps 4fps 1fps	24fps 12fps 4fps 1fps

- The available options for the H.264 transmission mode (Transmission priority) are limited to 30fps or lower (excluding 24fps).
- When the system frequency is 24/23.98Hz, the resolution for H.264(1) and H.264(2) is limited to 1920×1080.
- You cannot make settings above the resolution and frame rate set by the system format.

• When “Streaming mode” is set to “H.264(UHD)”

Settings		H.265(1)	H.265(2)	H.264(1)	H.264(2)	H.264(3)	H.264(4)	JPEG(1)	JPEG(2)	JPEG(3)
Resolution		—	—	3840×2160	—	—	—	1920×1080 1280×720 640×360 320×180	640×360 320×180	640×360 320×180
Frame rate	System frequency 59.94Hz	—	—	60fps 30fps	—	—	—	30fps 15fps 5fps 1fps	30fps 15fps 5fps 1fps	30fps 15fps 5fps 1fps
	System frequency 50Hz	—	—	50fps 25fps	—	—	—	25fps 12.5fps 5fps 1fps	25fps 12.5fps 5fps 1fps	25fps 12.5fps 5fps 1fps
	System frequency 29.97Hz	—	—	30fps	—	—	—	30fps 15fps 5fps 1fps	30fps 15fps 5fps 1fps	30fps 15fps 5fps 1fps
	System frequency 25Hz	—	—	25fps	—	—	—	25fps 12.5fps 5fps 1fps	25fps 12.5fps 5fps 1fps	25fps 12.5fps 5fps 1fps
	System frequency 24/23.98Hz	—	—	24fps	—	—	—	24fps 12fps 4fps 1fps	24fps 12fps 4fps 1fps	24fps 12fps 4fps 1fps

- The H.264(UHD) transmission mode (Transmission priority) cannot be selected.

Parts and their functions (continued)

• When “Streaming mode” is set to “JPEG (UHD)”

Settings		H.265(1)	H.265(2)	H.264(1)	H.264(2)	H.264(3)	H.264(4)	JPEG(1)	JPEG(2)	JPEG(3)
Resolution		—	—	1920×1080 1280×720	1920×1080 1280×720 640×360 320×180	1280×720 640×360 320×180	1280×720 640×360 320×180	3840×2160	—	—
Frame rate	System frequency 59.94Hz	—	—	60fps 30fps 15fps 5fps	60fps 30fps 15fps 5fps	30fps 15fps 5fps	30fps 15fps 5fps	5fps 1fps	—	—
	System frequency 50Hz	—	—	50fps 25fps 12.5fps 5fps	50fps 25fps 12.5fps 5fps	25fps 12.5fps 5fps	25fps 12.5fps 5fps	5fps 1fps	—	—
	System frequency 29.97Hz	—	—	30fps 15fps 5fps	30fps 15fps 5fps	30fps 15fps 5fps	30fps 15fps 5fps	5fps 1fps	—	—
	System frequency 25Hz	—	—	25fps 12.5fps 5fps	25fps 12.5fps 5fps	25fps 12.5fps 5fps	25fps 12.5fps 5fps	5fps 1fps	—	—
	System frequency 24/23.98Hz	—	—	24fps	24fps	—	—	4fps 1fps	—	—

- The available options for the H.264 transmission mode (Transmission priority) are limited to 30fps or lower (excluding 24fps).
- When the system frequency is 24/23.98Hz, the resolution for H.264(1) and H.264(2) is limited to 1920×1080.

• When “Streaming mode” is set to “RTMP”

Settings		H.265(1)	H.265(2)	H.264(1)	H.264(2)	H.264(3)	H.264(4)	JPEG(1)	JPEG(2)	JPEG(3)
Resolution		—	—	1920×1080 1280×720	—	—	—	1920×1080 1280×720 640×360 320×180	640×360 320×180	640×360 320×180
Frame rate	System frequency 59.94Hz	—	—	60fps 30fps 15fps 5fps	—	—	—	30fps 15fps 5fps 1fps	30fps 15fps 5fps 1fps	30fps 15fps 5fps 1fps
	System frequency 50Hz	—	—	50fps 25fps 12.5fps 5fps	—	—	—	25fps 12.5fps 5fps 1fps	25fps 12.5fps 5fps 1fps	25fps 12.5fps 5fps 1fps
	System frequency 29.97Hz	—	—	30fps 15fps 5fps	—	—	—	30fps 15fps 5fps 1fps	30fps 15fps 5fps 1fps	30fps 15fps 5fps 1fps
	System frequency 25Hz	—	—	25fps 12.5fps 5fps	—	—	—	25fps 12.5fps 5fps 1fps	25fps 12.5fps 5fps 1fps	25fps 12.5fps 5fps 1fps
	System frequency 24/23.98Hz	—	—	24fps	—	—	—	24fps 12fps 4fps 1fps	24fps 12fps 4fps 1fps	24fps 12fps 4fps 1fps

- The RTMP transmission mode (Transmission priority) cannot be selected.
- When the system frequency is 24/23.98Hz, the resolution for H.264(1) and H.264(2) is limited to 1920×1080.
- You cannot make settings above the resolution and frame rate set by the system format.

Parts and their functions (continued)

• When “Streaming mode” is set to “SRT(H.265)”

Settings		H.265(1)	H.265(2)	H.264(1)	H.264(2)	H.264(3)	H.264(4)	JPEG(1)	JPEG(2)	JPEG(3)
Resolution		1920×1080	—	—	—	—	—	1920×1080	—	—
		1280×720	—	—	—	—	—	1280×720	640×360	640×360
		640×360	—	—	—	—	—	640×360	320×180	320×180
		320×180	—	—	—	—	—	320×180	—	—
Frame rate	System frequency 59.94Hz	60fps 30fps	—	—	—	—	—	30fps 15fps 5fps 1fps	30fps 15fps 5fps 1fps	30fps 15fps 5fps 1fps
	System frequency 50Hz	50fps 25fps	—	—	—	—	—	25fps 12.5fps 5fps 1fps	25fps 12.5fps 5fps 1fps	25fps 12.5fps 5fps 1fps
	System frequency 29.97Hz	30fps	—	—	—	—	—	30fps 15fps 5fps 1fps	30fps 15fps 5fps 1fps	30fps 15fps 5fps 1fps
	System frequency 25Hz	25fps	—	—	—	—	—	25fps 12.5fps 5fps 1fps	25fps 12.5fps 5fps 1fps	25fps 12.5fps 5fps 1fps
	System frequency 24/23.98Hz	—	—	—	—	—	—	—	—	—

- The SRT(H.265) transmission mode (Transmission priority) cannot be selected.
- It is not possible to select SRT(H.265) mode when the system frequency is 24/23.98Hz.
- You cannot make settings above the resolution and frame rate set by the system format.

• When “Streaming mode” is set to “SRT(H.265 UHD)”

Settings		H.265(1)	H.265(2)	H.264(1)	H.264(2)	H.264(3)	H.264(4)	JPEG(1)	JPEG(2)	JPEG(3)
Resolution		3840×2160	—	—	—	—	—	1920×1080	—	—
		—	—	—	—	—	—	1280×720	640×360	640×360
		—	—	—	—	—	—	640×360	320×180	320×180
		—	—	—	—	—	—	320×180	—	—
Frame rate	System frequency 59.94Hz	30fps	—	—	—	—	—	30fps 15fps 5fps 1fps	30fps 15fps 5fps 1fps	30fps 15fps 5fps 1fps
	System frequency 50Hz	25fps	—	—	—	—	—	25fps 12.5fps 5fps 1fps	25fps 12.5fps 5fps 1fps	25fps 12.5fps 5fps 1fps
	System frequency 29.97Hz	30fps	—	—	—	—	—	30fps 15fps 5fps 1fps	30fps 15fps 5fps 1fps	30fps 15fps 5fps 1fps
	System frequency 25Hz	25fps	—	—	—	—	—	25fps 12.5fps 5fps 1fps	25fps 12.5fps 5fps 1fps	25fps 12.5fps 5fps 1fps
	System frequency 24/23.98Hz	—	—	—	—	—	—	—	—	—

- The SRT(H.265 UHD) transmission mode (Transmission priority) cannot be selected.
- It is not possible to select SRT(H.265 UHD) mode when the system frequency is 24/23.98Hz.

Parts and their functions (continued)

• When “Streaming mode” is set to “SRT(H.264)”

Settings		H.265(1)	H.265(2)	H.264(1)	H.264(2)	H.264(3)	H.264(4)	JPEG(1)	JPEG(2)	JPEG(3)
Resolution		—	—	1920×1080 1280×720	—	—	—	1920×1080 1280×720 640×360 320×180	640×360 320×180	640×360 320×180
Frame rate	System frequency 59.94Hz	—	—	60fps 30fps 15fps 5fps	—	—	—	30fps 15fps 5fps 1fps	30fps 15fps 5fps 1fps	30fps 15fps 5fps 1fps
	System frequency 50Hz	—	—	50fps 25fps 12.5fps 5fps	—	—	—	25fps 12.5fps 5fps 1fps	25fps 12.5fps 5fps 1fps	25fps 12.5fps 5fps 1fps
	System frequency 29.97Hz	—	—	30fps 15fps 5fps	—	—	—	30fps 15fps 5fps 1fps	30fps 15fps 5fps 1fps	30fps 15fps 5fps 1fps
	System frequency 25Hz	—	—	25fps 12.5fps 5fps	—	—	—	25fps 12.5fps 5fps 1fps	25fps 12.5fps 5fps 1fps	25fps 12.5fps 5fps 1fps
	System frequency 24/23.98Hz	—	—	—	—	—	—	—	—	—

- The SRT(H.264) transmission mode (Transmission priority) cannot be selected.
- It is not possible to select SRT(H.264) mode when the system frequency is 24/23.98Hz.
- You cannot make settings above the resolution and frame rate set by the system format.

• When “Streaming mode” is set to “SRT(H.264 UHD)”

Settings		H.265(1)	H.265(2)	H.264(1)	H.264(2)	H.264(3)	H.264(4)	JPEG(1)	JPEG(2)	JPEG(3)
Resolution		—	—	3840×2160	—	—	—	1920×1080 1280×720 640×360 320×180	640×360 320×180	640×360 320×180
Frame rate	System frequency 59.94Hz	—	—	60fps 30fps	—	—	—	30fps 15fps 5fps 1fps	30fps 15fps 5fps 1fps	30fps 15fps 5fps 1fps
	System frequency 50Hz	—	—	50fps 25fps	—	—	—	25fps 12.5fps 5fps 1fps	25fps 12.5fps 5fps 1fps	25fps 12.5fps 5fps 1fps
	System frequency 29.97Hz	—	—	30fps	—	—	—	30fps 15fps 5fps 1fps	30fps 15fps 5fps 1fps	30fps 15fps 5fps 1fps
	System frequency 25Hz	—	—	25fps	—	—	—	25fps 12.5fps 5fps 1fps	25fps 12.5fps 5fps 1fps	25fps 12.5fps 5fps 1fps
	System frequency 24/23.98Hz	—	—	—	—	—	—	—	—	—

- The SRT(H.264 UHD) transmission mode (Transmission priority) cannot be selected.
- It is not possible to select SRT(H.264 UHD) mode when the system frequency is 24/23.98Hz.

Parts and their functions (continued)

- When “Streaming mode” is set to “NDI|HX V2”

Settings		NDI HX	JPEG(1)
Resolution		1920×1080 1280×720	1280×720 640×360 320×180
Frame rate	System frequency 59.94Hz	60fps 30fps 15fps 5fps	30fps 15fps 5fps 1fps
	System frequency 50Hz	50fps 25fps 12.5fps 5fps	25fps 12.5fps 5fps 1fps
	System frequency 29.97Hz	30fps 15fps 5fps	30fps 15fps 5fps 1fps
	System frequency 25Hz	25fps 12.5fps 5fps	25fps 12.5fps 5fps 1fps

- It is not possible to select NDI|HX V2 mode when the system frequency is 24/23.98Hz.
- The transmission mode (Transmission priority) cannot be selected.
- You cannot make settings above the resolution and frame rate set by the system format.

- When “Streaming mode” is set to “MPEG2-TS over UDP”

Settings		H.265(1)	H.265(2)	H.264(1)	H.264(2)	H.264(3)	H.264(4)	JPEG(1)	JPEG(2)	JPEG(3)
Resolution		—	—	1920×1080 1280×720	—	—	—	1920×1080 1280×720 640×360 320×180	640×360 320×180	640×360 320×180
Frame rate	System frequency 59.94Hz	—	—	60fps 30fps 15fps 5fps	—	—	—	30fps 15fps 5fps 1fps	30fps 15fps 5fps 1fps	30fps 15fps 5fps 1fps
	System frequency 50Hz	—	—	50fps 25fps 12.5fps 5fps	—	—	—	25fps 12.5fps 5fps 1fps	25fps 12.5fps 5fps 1fps	25fps 12.5fps 5fps 1fps
	System frequency 29.97Hz	—	—	30fps 15fps 5fps	—	—	—	30fps 15fps 5fps 1fps	30fps 15fps 5fps 1fps	30fps 15fps 5fps 1fps
	System frequency 25Hz	—	—	25fps 12.5fps 5fps	—	—	—	25fps 12.5fps 5fps 1fps	25fps 12.5fps 5fps 1fps	25fps 12.5fps 5fps 1fps
	System frequency 24/23.98Hz	—	—	—	—	—	—	—	—	—

- The transmission mode (Transmission priority) cannot be selected.
- It is not possible to select MPEG2-TS over UDP mode when the system frequency is 24/23.98Hz.
- You cannot make settings above the resolution and frame rate set by the system format.

Wireless remote control: AW-RM50G (optional accessory)

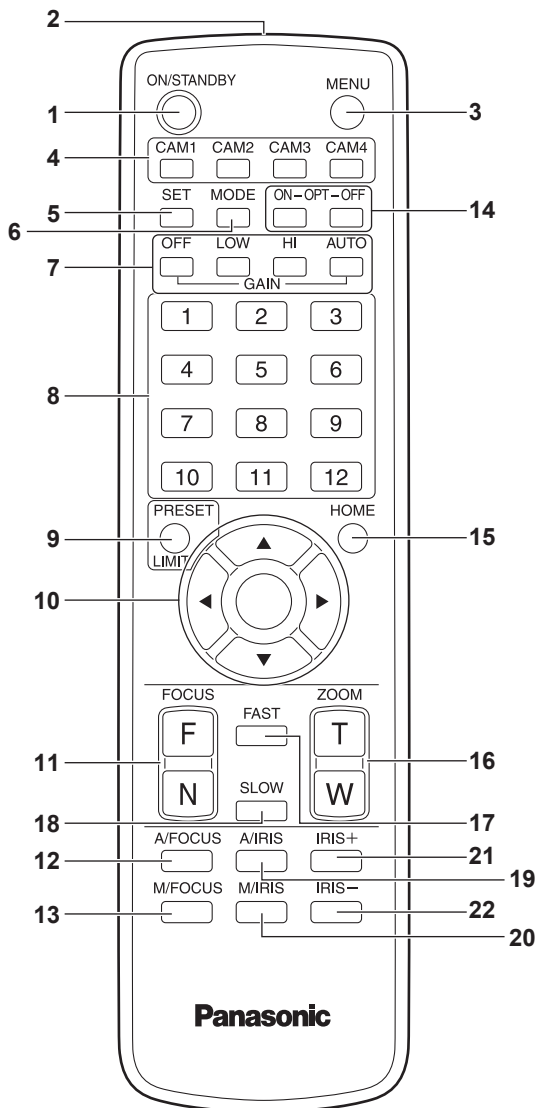

1. ON/STANDBY button <ON/STANDBY>

Each time this is pressed for 2 seconds, operation switches between turning on the unit's power and establishing the standby status.

2. Signal transmission window

3. MENU button <MENU>

Each time this is pressed for 2 seconds, operation switches between displaying the unit's camera menu and exiting the camera menu. When it is pressed quickly (for less than 2 seconds) while a camera menu is displayed, the setting change is canceled.

Furthermore, the pan and tilt movement range limits (limiters) are set and released by operating the <MENU> button, <PRESET/LIMIT> button and the pan/tilt buttons (<▲> <▼> <◀> <▶>).

For details, refer to "Setting/releasing the limiters" (→ page 157).

<NOTE>

- It is not possible to switch the 12G SDI/OPTICAL, 3G SDI, HDMI output camera menu displays in the factory settings. Switch the setting to [On] with the camera menu. (→ page 67)

4. CAM1 to CAM4 buttons

<CAM1> <CAM2> <CAM3> <CAM4>

Selects a camera to be operated.

Once a button has been selected, the unit corresponding to the selected button can be operated.

5. SET button <SET>

If this button is held down for 2 seconds when the [AWB A] memory or [AWB B] memory has been selected for the white balance adjustment, the black balance is adjusted automatically and registered in the memory selected.

When this button is pressed for under 2 seconds, only the white balance is adjusted automatically.

6. MODE button <MODE>

This is used to select the video signals which are output from the unit. Each time it is pressed, the signals are switched between the color bar signals and camera video signals.

<NOTE>

- When [Audio] is set to [On] and the color bar is displayed, a test sound (1 kHz) is output. Be cautious of the volume on external devices.

7. GAIN button <OFF> <LOW> <HI> <AUTO>

These are used to set the gain.

The gain increase can be set in three steps using the <OFF>, <LOW> and <HI> buttons.

<LOW> is set to 9 dB, and <HI> is set to 18 dB.

When the <AUTO> button is pressed, the AGC function is activated, and the gain is adjusted automatically depending on the light quantity. The maximum gain of the AGC function can be set using the camera menu.

8. Preset memory call buttons <1> to <12>

These are used to call the information on the unit's directions and other settings, which have been registered in the unit's preset memories No.1 to No.12, and reproduce those settings.

Settings in preset memories No.13 and above cannot be called from the wireless remote control.

9. PRESET/LIMIT button <PRESET/LIMIT>

This is used to register the settings in the preset memories or set or release the limiters.

When a preset memory call button is pressed while the <PRESET/LIMIT> button is held down, the information on the unit's current direction and other settings is registered in the call button.

Preset memory call buttons <1> to <12> correspond to the unit's No.1 to No.12 preset memories.

Furthermore, the pan and tilt movement range limits (limiters) are set and released by operating the <PRESET/LIMIT> button, <MENU> button and the pan/tilt buttons (<▲> <▼> <◀> <▶>).

For details, refer to "Setting/releasing the limiters" (→ page 157).

10. Pan-tilt buttons and menu operation buttons

<▲> <▼> <◀> <▶> <○>

1) These are used to change the unit's direction.

The unit is tilted in the up/down direction using the <▲> and <▼> buttons and panned in the left/right direction using the <◀> and <▶> buttons.

The <○> button does not work during tilting and panning.

When the <▲> or <▼> and <◀> or <▶> buttons are pressedd at the same time, the unit moves diagonally.

2) The buttons are used for menu operations when the unit displays the camera menus.

Use the <▲>, <▼> (<◀>, <▶>) buttons to select the menu items. When a selected item has a sub-menu, the sub-menu will be displayed by pressing the <○> button.

When the cursor is aligned with a particular item and the <○> button is pressed on the setting menu at the bottom hierarchical level, the setting of the selected item blinks.

When the <○> button is pressed after the setting has been changed using the <▲> and <▼> (<◀> and <▶>) buttons, the setting stops blinking, and the new setting is entered.

A setting for a regular menu item is reflected immediately if it is changed while it is still flashing.

If the <MENU> button is pressed quickly (for less than 2 seconds) while the setting is in the blinking status, the change will be canceled, and the setting selected prior to the change will be restored.

<NOTE>

- To prevent malfunctioning, there are a number of menu items ([Scene], [Format] and [Frequency]) whose setting is not reflected immediately even if it is changed while it is still flashing. It is reflected only after the <○> button has been pressed, causing the setting to stop flashing and the new setting to be entered.
- A confirmation screen appears before the settings of some menu items are to be entered.

11. FOCUS button <F> <N>

These are used to adjust the lens focus manually when the manual setting is established for the lens focus.

The focus is adjusted in the far using the <F> button and in the near using the <N> button.

12. A/FOCUS button <A/FOCUS>

This is used when automatically adjusting the lens focus.

13. M/FOCUS button <M/FOCUS>

This is used when manually adjusting the lens focus.

The FOCUS buttons (<F> and <N>) are used when performing the actual adjustment.

14. OPT button <ON> <OFF>

Turn night mode on/off.

<NOTE>

- In night mode, video output will be in black and white. In addition, the iris will be forcibly opened.
- White balance adjustment is not possible in night mode.
- ND filter switching is not possible in night mode.

15. HOME button <HOME>

When this is pressed for 2 seconds, the unit's direction (panning or tilting) returns to the reference position.

16. ZOOM button <T> <W>

These are used to adjust the lens zoom.

The zoom is adjusted in the wide-angle using the <W> button and in the telephoto using the <T> button.

17. FAST button <FAST>

This is used to change the movement speed at which the panning, tilting, zooming and focusing operations are performed to the high speed.

When the button is tapped, the movement speed can be set to the normal high-speed operation. When the button is held down, it can be set to an even faster high-speed operation. Tap the button to return the movement speed to the normal high-speed operation.

<NOTE>

- The operating speed for panning and tilting when the preset memory settings have been called can be changed using the "Preset Speed" item of the camera menu.

18. SLOW button <SLOW>

This is used to change the movement speed at which the panning, tilting, zooming and focusing operations are performed to the low speed.

When the button is tapped, the movement speed can be set to the normal low-speed operation. When the button is held down, it can be set to an even slower low-speed operation. Tap the button to return the movement speed to the normal low-speed operation.

19. A/IRIS button <A/IRIS>

This establishes the setting for adjusting the lens iris automatically in line with the light quantity.

20. M/IRIS button <M/IRIS>

This establishes the setting for adjusting the lens iris manually.

The <IRIS +> and <IRIS -> buttons are used when performing the actual adjustment.

21. IRIS + button <IRIS +>

This is used to adjust the lens iris in the opening direction.

22. IRIS - button <IRIS ->

This is used to adjust the lens iris in the closing direction.

Setting the remote control IDs

The wireless remote control (optional accessory) is capable of operating up to four units.

IDs are used to set which units are selected when the <CAM1>, <CAM2>, <CAM3> and <CAM4> buttons on the wireless remote control have been pressed.

- When operating a multiple number of these units using wireless remote controls, set a different remote control ID for each control.
- When using one unit, set the remote control ID to “CAM1” unless the setting needs to be changed.

■ Setting procedure

Operate the IR ID switches on the unit's rear panel, and select “CAM1”, “CAM2”, “CAM3” or “CAM4” as the remote control ID. (→ page 17)

The IR ID switch settings “CAM1” to “CAM4” correspond to the <CAM1> to <CAM4> buttons on the wireless remote control.

(The factory setting is “CAM1”.)

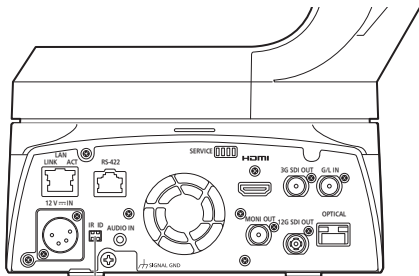

IR ID switches

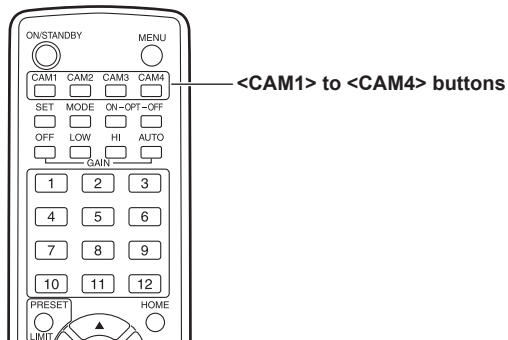

<CAM1> to <CAM4> buttons

Network settings

Using Easy IP Setup Software to make settings for the unit

The settings related to the unit's network can be established using the Easy IP Setup Software.

You can obtain Easy IP Setup Software (EasyIPSetup.exe) by downloading it from the following website.

<https://pro-av.panasonic.net/>

To establish the settings for a multiple number of units, the settings must be selected for each camera involved.

If the settings cannot be established using the Easy IP Setup Software, select the settings separately for the unit and personal computer on the Network setup screen [Network] of the setting menu. (→ page 132)

<NOTE>

- If, after the network settings have been established, another device in the same network has the same IP address, the network operations will not be performed properly.
Set the IP address in such a way that it does not duplicate an existing IP address.
- Do not establish network settings from a multiple number of Easy IP Setup Software programs at the same time for a single camera. Similarly, do not perform the "Auto IP setting" operation of the AW-RP150 remote camera controller at the same time.
The IP address settings may no longer be recognized as a result.
- To enhance the security of the Easy IP Setup Software, it will not be possible to make network settings for the target camera once about 20 minutes or more have elapsed after turning the power of the camera on. (When the [Easy IP Setup accommodate period] setting is [20min] → page 134)
- The Easy IP Setup Software cannot be used from a different subnet via a router.
- Use Easy IP Setup Software ver. 4.25R00 or newer.

1. Start the Easy IP Setup Software.

2. Click the [Search] button.

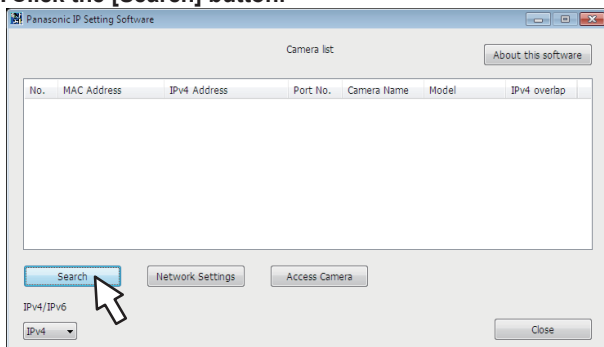

3. Click the MAC address/IPv4 address of the camera to be set, and click the [Network Settings] button.

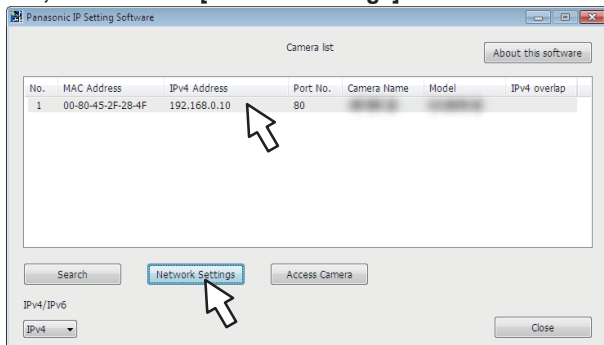

<NOTE>

- When a DHCP server is being used, the IP address allocated to the unit can be checked by clicking the [Search] button of the Easy IP Setup Software.
- If the same IP address is used for any additional cameras, the numbers of the additional cameras will be displayed in the [IPv4 overlap] column of the cameras concerned.
- When the [Access Camera] button is clicked, the Live screen of the selected camera is displayed.
- This unit supports an IPv4/IPv6 switching function.

4. Input the network items, and click the [Save] button.

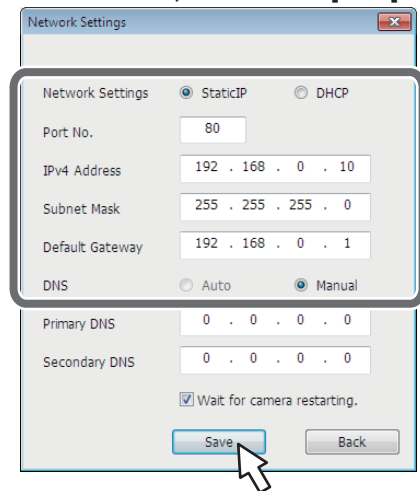

<NOTE>

- When a DHCP server is being used, [DNS] of the Easy IP Setup Software can be set to [Auto].
- After the [Save] button is clicked, it takes about 1 minute for the settings in the unit to be completed. If the external DC power supply or LAN cable is disconnected before the settings are completed, the settings will be canceled. In this case, repeat the steps to establish the settings.
- When a firewall (including software) has been introduced, enable access to all the UDP ports.

Using EasyIP Setup Tool Plus to make settings for the unit

You can use EasyIP Setup Tool Plus to make network related settings for this unit, display the camera images, and update the firmware. The app determines PTZ cameras for which updates are available and does the necessary operations from downloading the firmware to updating the version.

EasyIP Setup Tool Plus can be obtained by downloading from the following website.

<https://pro-av.panasonic.net/>

Refer to the Help page for EasyIP Setup Tool Plus for details.

Setting the initial account

1. Set the initial account.

In the initial state, the initial account setting screen is displayed when the web screen is displayed.

Set a user name and password. (→ page 86)

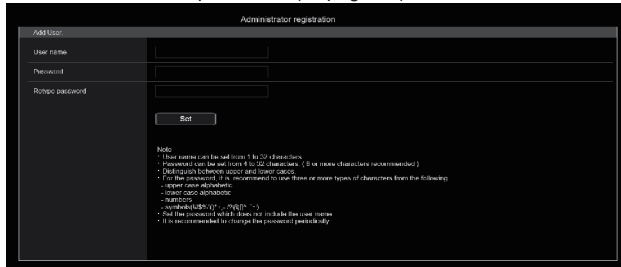

<NOTE>

- Do not set character strings that can be easily guessed by third parties.
- Change the password at regular intervals.
- The password must use at least 3 of the following 4 character types and be 8 characters or longer.
 - Alphabet upper cases
 - Alphabet lower cases
 - Numerals
 - Symbols (! # \$ % ' () * + , - . / ? @ [] ^ _ ` ~)
- When a password is set that does not adhere to the above policy, take responsibility for use of the device with due consideration for the security risks in the installation environment, etc.
- A warning is displayed if the set password goes against the recommended setting policy. When changing the password, click the [Back] button and set the password again.

When continuing with the setting with full understanding of the security risks, click [Continue] to complete the setting.
- If you forget the account information that was set, use the switches for initialization of service switches to reset the user information used for connecting to the network. (→ page 16)

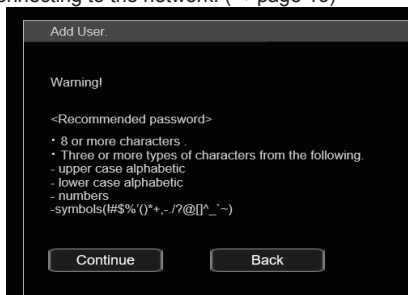

2. Completing registration of the initial account

After completing registration of the initial account, the following registration completed screen is displayed.

The live screen [Live] is automatically displayed after about 10 seconds elapse after the completed screen is displayed.

If the live screen [Live] is not displayed after 10 seconds elapse, manually move to the live screen [Live] by clicking the "please click here" link.

This completes the process of registering the initial account.

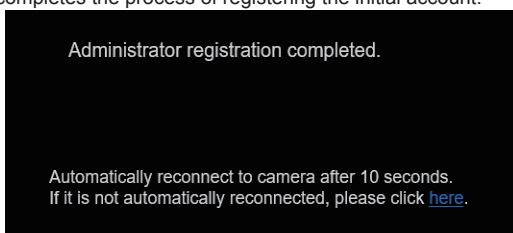

<NOTE>

- Network connection with AW-RP150 requires setup of an initial account.

When an initial account is not set up, AW-RP150 can detect but cannot control this unit.

Installing the plug-in viewer software

To view IP images from the unit on Windows Internet Explorer 11, the "Network Camera View 4S" plug-in viewer software (ActiveX®) must be installed.

The plug-in viewer software can be installed directly from the unit.

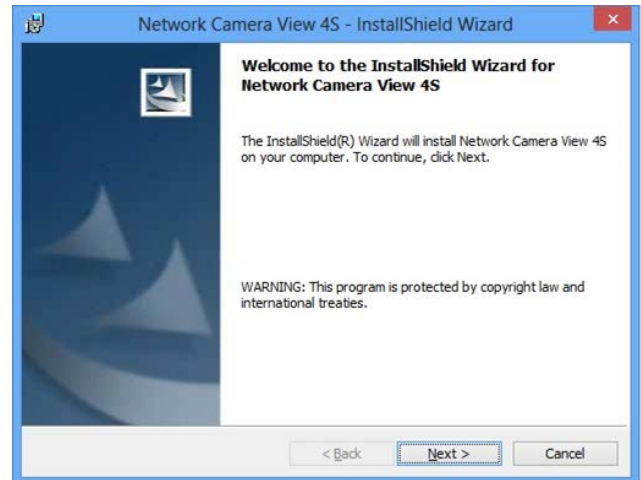

<NOTE>

- [Automatic installation of viewer software] is set to [On] at the time of purchase, allowing you to install directly from the unit. If a message appears in the web browser's information bar, see page 167.
- When you display the Live screen [Live] on the personal computer for the first time, the installation screen for the plug-in viewer software (ActiveX) appears. Follow the instructions on the screen to perform installation. (only when using Windows Internet Explorer 11)
- If the plug-in viewer software (ActiveX) installation screen continues to appear when switching screens, even after it is installed, restart the personal computer.
- A license is required for the plug-in viewer software for each personal computer on which it is installed. You can view the number of times the plug-in viewer software was automatically installed in the [Product info.] of the Maintenance screen [Maintenance] (→ page 149). For details on licenses, consult your local dealer.
- To uninstall the plug-in viewer software, select [Control Panel] - [Programs] - [Uninstall a program] in Windows, and remove "Network Camera View 4S".

Basic shooting operations

1. Set the subject brightness to the appropriate level.

2. Turn on the power of all the units and devices in the system.

3. Select the unit to be operated.

Even when using only one unit, it must still be selected from the wireless remote control or controller.

4. Select the shooting mode.

One of four shooting modes (Scene1, Scene2, Scene3 or Scene4) — whichever one will best suit the shooting conditions — can be selected.

The shooting modes are set by the user.

For details of the factory settings, refer to pages 79 to 85.

Select the mode that satisfies the shooting conditions and suits your preferences.

When continuing to shoot in the same circumstances, there is no need to select another mode.

5. Start shooting.

(After shooting, turn off the power of all the units and devices in the system.)

<NOTE>

- Some of the initial settings are auto settings and cannot be operated manually. To operate them manually, switch from the auto settings to the manual settings as required.

If the settings have already been changed and the original settings are to be restored, refer to the “What to do when encountering problems in the basic shooting operations” (→ page 35) and “Camera screen” (→ page 46) in “Camera menu items”.

How to turn the power on and off

Turning the power on

When performing operations from a wireless remote control

1. Set all the power switches of the units and devices connected in the system to ON.

- This unit does not have a power switch.

When power is supplied to it, the status display lamp will light orange, and the unit is set to the Standby mode.

<NOTE>

- Under factory default conditions, the unit will be in Standby mode when power is supplied for the first time. (Status display lamp: Lit orange)
- When the power supply is cut off while the unit is in Standby mode, the unit will be in Standby mode the next time power is supplied. (Status display lamp: Lit orange)
- When the power supply is cut off while the unit is in Power ON mode, the unit will be in Power ON mode the next time power is supplied. (Status display lamp: Lit green)

2. Press one of the <CAM1> to <CAM4> buttons on the wireless remote control to select the unit.

3. Press the <ON/STANDBY> button on the wireless remote control for about 2 seconds.

The Power ON mode is established, images are output, and control can be exercised.

- The unit's status display lamp now lights up green.

<NOTE>

- It takes maximum 30 seconds per unit for the initial settings operation to be completed. During this period, the unit cannot be operated. (Status display lamp: Lit orange)

4. If a multiple number of units are going to be used, repeat steps 2 and 3 as required.

The unit's status display lamp blinks green when a signal matched by the remote control ID has been received, and it blinks orange when a signal that is not matched by the remote control ID has been received.

<NOTE>

- When operation is transferred to the Standby mode:
The current zoom, focus and iris positions are stored in the memory (Power ON preset).
- When operation is transferred to the Power ON mode:
The zoom, focus and iris are adjusted to the positions which were stored in the memory (Power ON preset) when operation was transferred to the Standby mode.

When performing operations from a controller

When using an AW-RP150

For details, refer to the operating instructions for the controller.

When using a commercially available controller

For details, refer to the operating instructions for the controller.

Turning the power off

When performing operations from a wireless remote control

1. Press one of the <CAM1> to <CAM4> buttons on the wireless remote control to select the unit.

2. Press the <ON/STANDBY> button on the wireless remote control for about 2 seconds.

The unit enters Standby mode.

- The unit's status display lamp now lights up orange.

3. If a multiple number of units are going to be used, repeat steps 1 and 2 as required.

4. Set all the power switches of the units and devices connected in the system to OFF.

- This unit does not have a power switch.

<NOTE>

- When operation is transferred to the Standby mode:
The current zoom, focus and iris positions are stored in the memory (Power ON preset).
- When operation is transferred to the Power ON mode:
The zoom, focus and iris are adjusted to the positions which were stored in the memory (Power ON preset) when operation was transferred to the Standby mode.

When performing operations from a controller

When using an AW-RP150

For details, refer to the operating instructions for the controller.

When using a commercially available controller

For details, refer to the operating instructions for the controller.

Selecting the units

Select the unit (or units) to be operated from the wireless remote control or controller.

Even when using only one unit, it must still be selected.

When performing operations from a wireless remote control

Up to four units can be operated using one wireless remote control.

To select the unit using the wireless remote control, the IR ID switches on the unit's back panel must be set.

For details of the IR ID switch settings, refer to page 17 and page 27.

1. Press the <CAM1>, <CAM2>, <CAM3>, or <CAM4> button.

The unit's status display lamp blinks green when a signal matched by the remote control ID has been received, and it blinks orange when a signal that is not matched by the remote control ID has been received.

When performing operations from a controller

A maximum of five units can be operated by one controller when using serial control.

When using an AW-RP150

For details, refer to the operating instructions for the controller.

- Network connection with AW-RP150 requires setup of an initial account. (→ page 29)
When an initial account is not set up, AW-RP150 can detect but cannot control this unit.
- When operating the camera on a network with a controller, such as the AW-RP150, and [Serial] or [IP] of [Tracking Data Output] is set to [On], the tracking data output may be delayed or the value may not be updated. (→ page 61)

Selecting the shooting modes (scene files)

Types of shooting modes

One of four shooting modes (Scene1, Scene2, Scene3 or Scene4) — whichever one will best suit the shooting conditions — can be selected. The shooting modes are set by the user.

For details of the factory settings, refer to pages 79 to 85.

Select the mode that satisfies the shooting conditions and suits your preferences.

The settings can be changed by menu operations.

- The results of the white balance and other adjustments are stored in the memory separately by shooting mode. Be absolutely sure to select the shooting mode before making any adjustments.

<NOTE>

- Some of the initial settings are auto settings and cannot be operated manually. To operate them manually, switch from the auto settings to the manual settings as required.

[Scene1]

[Scene2]

[Scene3]

[Scene4]

The settings of your preferences can be established in line with the shooting scene, lighting and other conditions.

- When switching between shooting modes (Scene1, Scene2, Scene3, Scene4), and [Serial] or [IP] of [Tracking Data Output] is set to [On], the tracking data output may be delayed or the value may not be updated. (→ page 61)

How to select the shooting mode

When performing operations from a wireless remote control

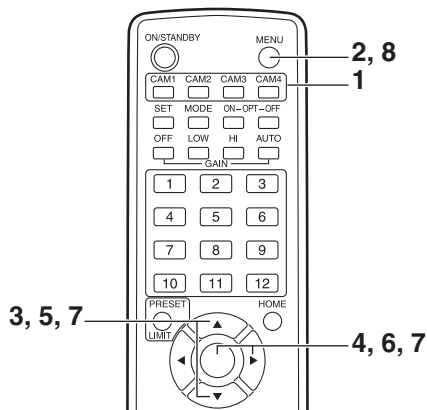

1. Press the <CAM1>, <CAM2>, <CAM3> or <CAM4> button to select the unit.

2. Press and hold the <MENU> button for about 2 seconds.

The Top Menu is displayed.

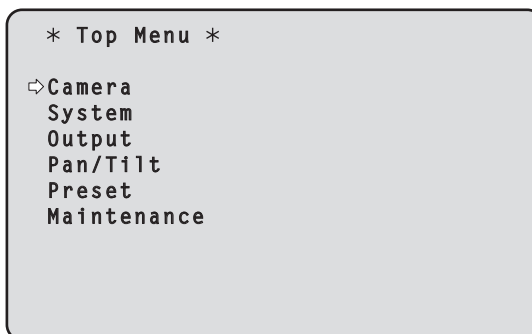

3. Press the <▲> or <▼> button to bring the cursor to [Camera].

4. Press the <○> button.

The [Camera] menu is displayed on the monitor.

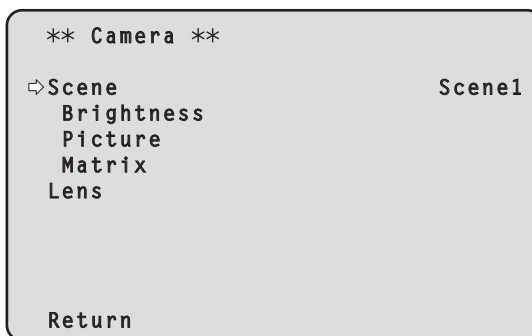

5. Press the <▲> or <▼> button to bring the cursor to [Scene].

6. Press the <○> button.

The shooting mode blinks.

7. Press the <▲> or <▼> button to select the shooting mode (Scene1, Scene2, Scene3 or Scene4) to be used, and press the <○> button to enter the selection.

8. Press and hold the <MENU> button for about 2 seconds.

The camera menu display is exited.

When performing operations from a controller

When using an AW-RP150

For details, refer to the operating instructions for the controller.

Shooting

When performing operations from a wireless remote control

■ Changing the camera's direction

Moving the camera toward the left or right (panning):

Press the <◀> or <▶> button.

Moving the camera up or down (tilting):

Press the <▲> or <▼> button.

Moving the camera diagonally:

Press the <▲> or <▼> button and <◀> or <▶> button at the same time.

Returning the camera to the reference position:

Press the <HOME> button for about 2 seconds.

■ Using the zoom function

Zooming in (the subject becomes magnified in size):

Press the <T> button of <ZOOM>.

Zooming out (the subject becomes reduced in size):

Press the <W> button of <ZOOM>.

■ Switching the panning/tilting and lens operation speed

Changing the direction or zoom at high speed:

Press the <FAST> button.

When this button is held down, the speed can be set to an even higher speed.

When it is tapped, the normal speed (high speed) is restored.

Changing the direction or zoom at low speed:

Press the <SLOW> button.

When this button is held down, the speed can be set to an even lower speed.

When it is tapped, the normal speed (low speed) is restored.

The speeds at which the pan, tilt, zoom, focus and iris are controlled are now switched.

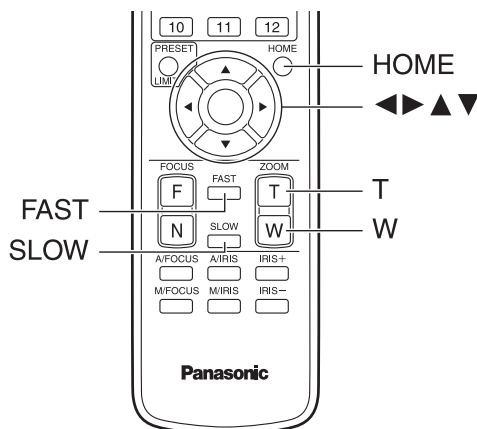

When performing operations from a controller

■ Changing the camera's direction

Moving the camera toward the left or right (panning):

Tilt the <PAN/TILT> lever toward L or R.

Moving the camera up or down (tilting):

Tilt the <PAN/TILT> lever toward UP or DOWN.

Moving the camera diagonally:

Tilt the <PAN/TILT> lever diagonally.

■ Using the zoom function

Zooming in (the subject becomes magnified in size):

Tilt the <ZOOM> lever toward the TELE direction.

Zooming out (the subject becomes reduced in size):

Tilt the <ZOOM> lever toward the WIDE direction.

■ Switching the panning/tilting and lens operation speed

When using an AW-RP150

For details, refer to the operating instructions for the controller.

What to do when encountering problems in the basic shooting operations

If the trouble is not resolved by taking the action suggested below, refer to "Troubleshooting" (→ page 159).

When performing operations from a wireless remote control

The unit does not move.

- Press the <CAM1>, <CAM2>, <CAM3> or <CAM4> button to select the unit which is to be operated.
If only one unit is being used, it is normally selected using the <CAM1> button.
- Check that the IR ID switches have been set correctly. (→ page 17, page 27)
- If the unit's status display lamp is off or lights up orange, it means that the unit's power is not on.
Refer to "Turning the power on" (→ page 31), and turn on the power.
- If the unit's status display lamp does not blink even when the wireless remote control is operated near the unit's wireless remote control signal light-sensing area, it means that the wireless remote control's batteries have run down.
Replace the batteries.

Multiple color bands (color bars) are displayed.

Switch to the camera image by pressing the <MODE> button.

The menu screen is displayed.

Press the <MENU> button for 2 seconds to exit the camera menu.

The lens focus is not adjusted automatically.

Press the <A/FOCUS> button to switch to auto focusing.

The camera picture is too light or too dark.

- Press the <A/IRIS> button to switch the lens iris adjustment to auto.
- Press the <AUTO> button of <GAIN> to switch the gain adjustment to auto.

Something is wrong with the coloring of the camera pictures.

Refer to "Auto tracking white adjustment (ATW)" (→ page 40), and switch to [ATW].

The camera menus are not displayed.

Restart the camera and open any of the camera menus within about a minute, the menus will be displayed in all the outputs.

Check [OSD Mix] (→ page 67) on the camera menu [Output 6/9] screen.

When performing operations from a controller

The unit does not move.

- Select the unit to be operated by following the procedure below.
When using an AW-RP150
For details, refer to the operating instructions for the controller.

- If the unit's status display lamp is off or lights up orange, it means that the unit's power is not on.
Refer to "Turning the power on" (→ page 31), and turn on the power.
- Check that the account settings for this unit have been set correctly. (→ page 87)
- Network connection with AW-RP150 requires setup of an initial account. (→ page 29)
When an initial account is not set up, AW-RP150 can detect but cannot control this unit.

Multiple color bands (color bars) are displayed.

Switch to the camera image by pressing the <BARS> button.

The lens focus is not adjusted automatically.

Press the <AUTO> button of <FOCUS> to switch to auto focusing.

The camera picture is too light or too dark.

- Press the <AUTO> button of <IRIS> to switch the lens iris adjustment to auto.
- Press the <AUTO> button of <GAIN> to switch the gain adjustment to auto.

Something is wrong with the coloring of the camera pictures.

Refer to "Auto tracking white adjustment (ATW)" (→ page 40), and switch to [ATW].

The camera menus are not displayed.

Restart the camera and open any of the camera menus within about a minute, the menus will be displayed in all the outputs.

Check [OSD Mix] (→ page 67) on the camera menu [Output 6/9] screen.

More advanced operations

Manual shooting (→ page 37)

- Manually adjusting the focus
- Manually adjusting the iris
- Manually adjusting the shutter speed
- Manually adjusting the gain

Preset memories (→ page 38)

- Up to 100 settings for the camera direction (panning and tilting), zoom, focus, iris, gain up and white balance can be registered in the preset memories, and called.
- The number of settings that can be registered and called depends on the type of wireless remote control (12 settings) or controller that is used for operation.

White balance adjustment (→ pages 39 to 40)

- This adjustment is performed to express the white accurately. Its setting also has an effect on the color tones of the entire screen.
- It must be performed when using the unit for the first time or when the unit has not been used for a prolonged period.
- Perform adjustment when the lighting conditions or brightness changes.
- Once the white balance has been attained, no further adjustment is required provided that the unit is going to be used under the same conditions.
- White balance adjustment is not possible in night mode.

Black balance adjustment (→ page 41)

- This adjustment is performed to express the black accurately. Its setting also has an effect on the color tones of the entire screen.
- It must be performed when using the unit for the first time or when the unit has not been used for a prolonged period.
- It must be performed when the ambient temperature has changed significantly and at the change of the seasons.
- Once the black balance has been attained, no further adjustment is required provided that the unit is going to be used under the same conditions.

Black level (master pedestal) adjustment (→ page 42)

- This adjustment is performed to align the black level (pedestal level) of a multiple number of cameras.
- Ask your dealer to perform this adjustment.

Genlock adjustment (→ page 43)

- This adjustment is performed to achieve phase alignment by applying external synchronization (genlock) when a multiple number of cameras will be used or when the unit will be used in combination with other devices.
- Ask your dealer to perform this adjustment.

Manual shooting

Manually adjusting the focus

The lens focus can be adjusted manually.

When performing operations from a wireless remote control

1. Press the <M/FOCUS> button to switch the focus to manual adjustment.
2. Press the <F> or <N> button of <FOCUS> to adjust the focus.
When the <F> button is pressed, the focus moves further away (far); conversely, when the <N> button is pressed, it moves nearer (near). The speed of focusing and other adjustments can be switched to fast or slow by pressing the <FAST> or <SLOW> button, respectively.
3. If necessary, press the <A/FOCUS> button to return the focus to the automatic adjustment.

When performing operations from a controller

When using an AW-RP150

For details, refer to the operating instructions for the controller.

<NOTE>

- When the focus is set to manual, the subject may go out of focus during panning, tilting and zooming. Therefore, the unit comes with a function which compensates for this. (Focus Adjust With PTZ.) If the function has been set to [Off], either adjust the focus, as required, after zooming or set the focus to auto. (→ page 71, page 96, page 126)
- When switching between focus modes (Manual/Auto), and [Serial] or [IP] of [Tracking Data Output] is set to [On], the tracking data output may be delayed or the value may not be updated. (→ page 61)

Manually adjusting the iris

The lens iris can be adjusted manually.

When performing operations from a wireless remote control

1. Press the <M/IRIS> button to switch the iris to manual adjustment.
2. Press the <IRIS +> or <IRIS -> button to adjust the iris.
Press the <IRIS +> button to adjust the lens iris in the opening direction; conversely, press the <IRIS -> button to adjust the lens iris in the closing direction.
The speed of the iris and other adjustments can be switched to fast or slow by pressing the <FAST> or <SLOW> button, respectively.
3. If necessary, press the <A/IRIS> button to return the iris to the automatic adjustment.

When performing operations from a controller

When using an AW-RP150

For details, refer to the operating instructions for the controller.

<NOTE>

- In the night mode, the iris is set to open as a measure to prevent video spying.
Adjust the brightness at the light source.
- When switching between iris modes (Manual/Auto), and [Serial] or [IP] of [Tracking Data Output] is set to [On], the tracking data output may be delayed or the value may not be updated. (→ page 61)

Manually adjusting the shutter speed

The shutter speed can be set using two methods. One is a method that specifies the time (where a time such as 1/250 sec. is designated), and the other is a method that specifies the frequency (where synchro scan, 60.15 Hz, etc. is designated).

When shooting a TV screen or personal computer's monitor screen, the horizontal noise generated when the screen is shot can be minimized by adjusting the frequency to the screen frequency using synchro scan.

When performing operations from a wireless remote control

Perform the adjustments on the Camera menu.

For details, refer to the [Shutter Mode] (→ page 47) and [Step/Synchro] (→ page 47).

When performing operations from a controller

When using an AW-RP150

For details, refer to the operating instructions for the controller.

Manually adjusting the gain

There are two ways to adjust the gain. One way involves using the buttons on the wireless remote control or controller; the other way involves using the Camera menu or Web setup screen [Setup]. The gain can be adjusted more precisely using the Camera menu or Web setup screen [Setup].

For details, refer to the [Gain] (→ page 47, page 116).

<NOTE>

- When adjusting the gain, the light quantity may change suddenly (causing the image output to be subjected to a shock).

When performing operations from a wireless remote control

1. Press one of the <GAIN> buttons (<OFF>, <LOW> or <HI>).
These buttons enable the gain increase to be selected in three steps. The <LOW> button is used to select 9 dB; the <HI> button is used to select 18 dB.
2. If necessary, press the <AUTO> button of <GAIN> in order to return the gain to the automatic adjustment (AGC).

When performing operations from a controller

When using an AW-RP150

For details, refer to the operating instructions for the controller.

In any case, the maximum gain of the automatic adjustment (AGC) can be set by the camera menu or Web setup screen [Setup].
For details, refer to the [AGC Max Gain] (→ page 47, page 116).

Preset memories

This unit enables up to 100 settings for the camera direction (panning and tilting), zoom, focus, iris, gain and white balance to be registered in its preset memories, and called.

However, the number of settings that can be registered and called depends on the type of wireless remote control or controller that is used for operation.

- The focus and iris operating modes (manual and auto settings) are neither registered nor recalled. The current focus and iris values are registered.
- The focus and iris values can be recalled only when the manual settings are applicable.
- For the white balance, the current White Balance Mode adjustment values are registered. If a preset value is recalled when AWB A or AWB B is selected, the adjustment value selected when it was registered as a preset will be recalled. The R Gain and B Gain values return to 0 in such cases.

<NOTE>

- When there is a large difference in the environmental temperature between the time of registration and the time the setting is called, displacement of the preset position may occur.
- If displacement occurs, perform registration again.
- When a manual operation is performed for pan, tilt, zoom, focus or iris during preset recall, the preset operation for the pan, tilt, zoom, focus or iris operation concerned will be aborted.
- If another preset has been recalled during an ongoing preset recall, the preset being recalled is aborted, and operation for the preset called last is performed instead.
- When recalling the preset memory during an ongoing preset memory recall (the first preset memory recall is aborted and performing the subsequent preset memory recall), and [Serial] or [IP] of [Tracking Data Output] is set to [On], the tracking data output may be delayed or the value may not be updated. (→ page 61)

When performing operations from a wireless remote control

Twelve settings (preset No.1 to No.12) can be registered and called using the wireless remote control.

The <1> to <12> buttons correspond to the unit's preset memories No.1 to No.12.

■ Registering the settings in the preset memories

1. Display the picture to be shot on the monitor.

Operate the pan, tilt or zoom buttons to determine the camera angle. Adjust the focus, iris, gain and white balance if they need to be adjusted.

2. While holding down the <PRESET> button, press the button corresponding to the preset memory number.

- If a preset memory number with an already registered setting has been selected, the existing setting will be erased and replaced with the new one.

■ Calling the settings of the preset memories

1. Press the button in which the preset memory setting has been registered.

When performing operations from a controller

When using an AW-RP150

Up to 100 entries can be registered/recalled.

For details, refer to the operating instructions for the controller.

White balance adjustment

Adjust the ratio between the three primary colors (RGB) to reproduce white accurately. If the white balance is out of adjustment, not only will white be reproduced poorly, but the color tones of the screen as a whole will also be degraded.

- Perform adjustment when using the unit for the first time or when the unit has not been used for a prolonged period.
- Perform adjustment when the lighting conditions or brightness changes.

Either "AWB" (automatic white balance adjustment) which initiates automatic adjustment when the <AWB> button on the controller has been pressed or "ATW" (automatic tracking white balance adjustment) which constantly adjusts the white balance can be selected for adjustment purposes.

The results of the AWB adjustment can be stored in two memories, A and B, when [AWB A] or [AWB B] has been selected for the white balance.

- Once the white balance values have been adjusted, their setup procedure will be completed simply by selecting them using the camera menus or Web setup screen [Setup], or by pressing the buttons on the controller, provided that they are going to be used under the same conditions as the ones established when the values were set. There is no need to set it again.
- Once a new setting is entered, the previous setting will be erased.
- White balance adjustment is not possible in night mode.
- The white balance cannot be adjusted during preset playback.

Use the two memories to store settings corresponding to different shooting conditions.

<NOTE>

- After adjusting the white balance, and [Serial] or [IP] of [Tracking Data Output] is set to [On], the tracking data output may be delayed or the value may not be updated. (→ page 61)

Automatic adjustment (AWB: AWB A or AWB B)

When performing operations from a wireless remote control

1. Shoot a white subject (such as a white wall or handkerchief) so that it fills the screen.

- Do not shoot shiny or very bright objects.

- Steps 2 through 8 represent the procedure for selecting the [AWB A] or [AWB B] memory. They need not be taken if a selection has already been made.

2. Select [Scene1], [Scene2], [Scene3] or [Scene4] as the shooting mode by following the procedure in "Selecting the shooting modes (scene files)" (→ page 33).

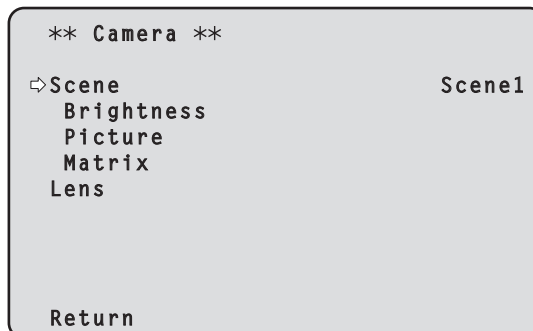

3. Press the <▲> or <▼> button to bring the cursor to [Picture].

4. Press the <○> button.

The [Picture 1/8] screen is displayed.

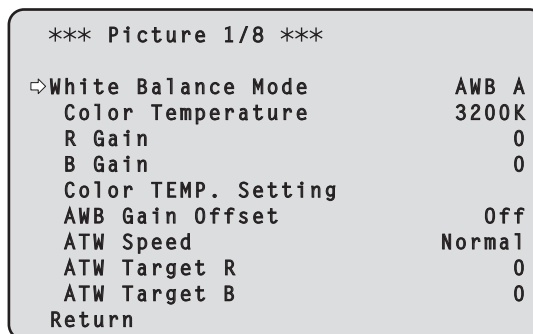

5. Press the <▲> or <▼> button to bring the cursor to [White Balance Mode].

6. Press the <○> button.

[White Balance Mode] starts blinking.

7. Press the <▲> or <▼> button to change the White Balance Mode to be used to [AWB A] or [AWB B], and press the <○> button to enter the selection.

8. Press and hold the <MENU> button for about 2 seconds.

The camera menu display is exited.

White balance adjustment (continued)

9. Press the <SET> button for about 2 seconds.

The auto white balance adjustment (AWB) and auto black balance adjustment (ABB) are performed, and the white balance setting is entered.

- When [On] has been selected as the [OSD Status] (→ page 68) setting, the “AWB OK” message will appear at the center of the screen when the white balance adjustment is completed successfully.

When the black balance adjustment is completed successfully, the “ABB OK” message appears at the center of the screen.



<NOTE>

- The black balance is set at the same time.
When this takes place, the lens is closed and then the adjustment is performed so the screen will temporarily turn black.
When only the auto white balance adjustment (AWB) is to be performed, ensure that the <SET> button is pressed or held down for a period of time which does not exceed 2 seconds.
- Adjustment cannot be performed while the color bar is displayed.
Switch to the camera image by pressing the <MODE> button.
- The white balance cannot be adjusted during preset playback.
- When the adjustment has failed, an error message such as “OUT RANGE NG”, “HIGH LIGHT NG”, “LOW LIGHT NG” or “ATW NG” is displayed.

When performing operations from a controller

When using an AW-RP150

For details, refer to the operating instructions for the controller.

<NOTE>

- White balance may not be correctly set if the lighting of the object is too weak.
- Since the unit has a built-in memory, the set white balance will remain in the memory even if power is turned off. Therefore, it is not necessary to reset the white balance if the color temperature of those objects remains unchanged. However, it must be reset if the color temperature changes, such as when you move from indoors to outside, or vice versa.

Auto tracking white adjustment (ATW)

When the white balance adjustment is set to [ATW], the white balance continues to be adjusted automatically all the time, and it is automatically corrected even when the light source or color temperature has changed to produce completely natural pictures.

This function works when [ATW] is selected instead of [AWB A] or [AWB B] by following the steps for “Automatic adjustment” in “White balance adjustment” (→ page 39).

<NOTE>

- ATW might not function properly when high brightness light (ex. fluorescent lamp) beams into a screen.
- White balance may not be accurately set if there is no white object in the scene being shot.
- The white balance may shift out of adjustment when different kinds of light sources such as sunlight and fluorescent lighting are applied.

3200K and 5600K presets

When [3200K] or [5600K] is selected for the white balance, the white balance is set using a color temperature of 3200 K (equivalent to halogen light) or 5600 K (equivalent to daylight), respectively. This function works when [3200K] or [5600K] is selected instead of [AWB A] or [AWB B] by following the steps for “Automatic adjustment” in “White balance adjustment” (→ page 39).

VAR

When [VAR] is selected for the white balance, you can select a color temperature between 2000K and 15000K.

<NOTE>

- The displayed [VAR] value does not guarantee an absolute value. Use the value as a reference.

Black balance adjustment

Adjust the zero levels of the three primary colors (RGB) to reproduce black accurately. If the black balance is out of adjustment, not only will black be reproduced poorly, but the color tones of the screen as a whole will also be degraded.

Readjustment of the black balance is not required under normal circumstances but is necessary in the following situations.

- **Perform adjustment when using the unit for the first time or when the unit has not been used for a prolonged period.**
- **Perform adjustment when the ambient temperature changes significantly, such as during changes of the season.**

<NOTE>

- After adjusting the black balance, and [Serial] or [IP] of [Tracking Data Output] is set to [On], the tracking data output may be delayed or the value may not be updated. (→ page 61)

Automatic adjustment

When performing operations from a wireless remote control

The procedure is identical to that of "Automatic adjustment" (→ page 39) in "White balance adjustment".

The black balance can be configured by performing automatic white balance adjustment (AWB) and automatic black balance adjustment (ABB).

- The white balance will also be configured, so be sure to prepare the conditions for white balance adjustment before performing the procedure.
- Adjustment cannot be performed while the color bar is displayed. Switch to the camera image by pressing the <MODE> button.
- The black balance cannot be adjusted during preset playback.

When performing operations from a controller

When using an AW-RP150

For details, refer to the operating instructions for the controller.

Black level (master pedestal) adjustment

The black level can be adjusted when using a multiple number of cameras including the unit. Ask your dealer to perform this adjustment. (Use an oscilloscope or waveform monitor for the adjustment.) Adjust the black level in accordance with the units and devices used.

When performing operations from a controller

When using an AW-RP150

For details, refer to the operating instructions for the controller.

When performing operations from a wireless remote control

1. Press the <M/IRIS> button.

Set the iris to the manual mode.

2. Press the <IRIS →> button.

The lens iris is stopped down.

3. Press the <▲> or <▼> button to bring the cursor to [Picture].

4. Press the <○> button.

The [Picture 2/8] screen is displayed.

```
*** Picture 2/8 ***
◁ Chroma Level          0%
  Chroma Phase          0
  Master Pedestal      0
  R Pedestal           0
  G Pedestal           0
  B Pedestal           0
  Pedestal Offset     0ff

Return
```

5. Press the <▲> or <▼> button to bring the cursor to [Master Pedestal].

```
*** Picture 2/8 ***
  Chroma Level          0%
  Chroma Phase          0
◁ Master Pedestal      0
  R Pedestal           0
  G Pedestal           0
  B Pedestal           0
  Pedestal Offset     0ff

Return
```

6. Press the <○> button to start the [Master Pedestal] value blinking.

7. Press the <▲> or <▼> button, change the [Master Pedestal] value, and press the <○> button to enter the selection.

Adjust the value so that it matches the black level.

The pedestal values can be adjusted finely using the [R Pedestal], [G Pedestal] and [B Pedestal] settings. (→ page 50, page 119)

8. Press and hold the <MENU> button for about 2 seconds.

The camera menu display is exited.

9. If necessary, press the <A/IRIS> button to adjust the iris automatically.

Genlock adjustment

The genlock adjustment is performed to achieve phase alignment by applying external synchronization (genlock) when a multiple number of cameras will be used or when the unit will be used in combination with other devices.

This unit supports BBS (Black Burst Sync) and tri-level sync external synchronization signals.

Ask your dealer to perform this adjustment.

(Use a dual-trace oscilloscope for the adjustment.)

Horizontal phase adjustment

Observe the waveforms of the external sync signal input (tri-level sync signal) and video signal output on the dual-trace oscilloscope, and use the wireless remote control or controller to bring the horizontal phase into alignment.

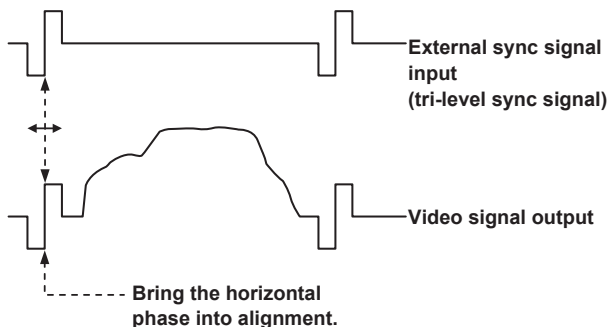

Example: When the tri-level sync phase is adjusted

When performing operations from a wireless remote control

1. Follow the operation steps in “Basic setup operations” (→ page 44) to display the Top Menu.

2. Press the <▲> or <▼> button to bring the cursor to [System].

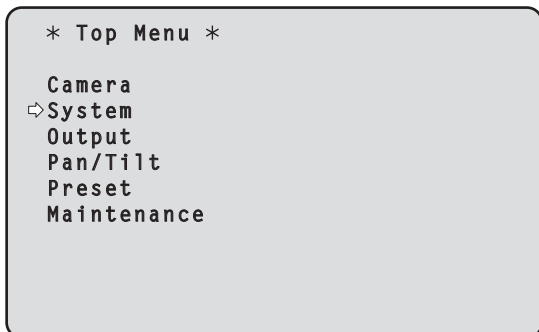

3. Press the <○> button.

The [System 1/2] screen appears.

4. Press the <▲> or <▼> button to bring the cursor to [Genlock], and press the <○> button.

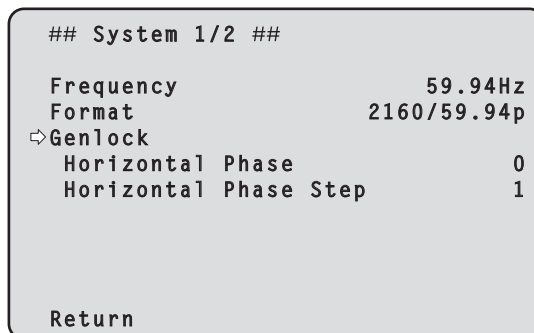

5. Press the <▲> or <▼> button to bring the cursor to [Horizontal Phase], and press the <○> button.

The [Horizontal Phase] value starts blinking.

6. Press the <▲> or <▼> button to change the [Horizontal Phase] value, adjust the value so that the horizontal phase is brought into alignment, and press the <○> button.

The extent of the phase adjustment can be selected using [Horizontal Phase Step].

7. Press and hold the <MENU> button for about 2 seconds.

The camera menu display is exited.

Basic setup operations

Camera menus are displayed on the monitor when the unit's settings are to be selected.

The monitor is connected to the video signal output connector.

The basic camera menu operations involve displaying sub-menus from the Top Menu items, and selecting settings on the sub-menus.

Some sub-menus have menu items for performing more detailed settings.

The camera menu operations are conducted using the wireless remote control.

Described below are the Basic setup operations for changing the camera menu item settings using the wireless remote control.

■ Wireless remote control operations

Camera menu operation	Wireless remote control
Selecting a camera to operate	Press the <CAM1>, <CAM2>, <CAM3>, or <CAM4> button.
Displaying the Top Menu	Press and hold the <MENU> button for about 2 seconds.
Selecting items	Press the <▲>, <▼>, <◀>, or <▶> button.
Displaying sub-menus	Press the <○> button.
Returning to the previous menu	Place the cursor on [Return], and press the <○> button.
Changing settings	Place the cursor on the item you want to change, and press the <○> button to make the setting value blink. Change the value using the <▲>, <▼>, <◀>, or <▶> button, and press the <○> button to confirm.
Canceling setting changes	Press the <MENU> button (hold for less than 2 seconds) while the setting value is blinking.
Exiting camera menu operations	Press and hold the <MENU> button for about 2 seconds.

<NOTE>

- When AW-RP150 is connected, refer to the operating instructions for the controller.

When performing the operations using the wireless remote control

1. Press the <CAM1>, <CAM2>, <CAM3> or <CAM4> button to select the unit which is to be operated.

2. Press and hold the <MENU> button for about 2 seconds.
The Top Menu is displayed.

3. Press the <▲> or <▼> button to bring the cursor to the item to be selected.

Each time the <▲> or <▼> button is pressed, the cursor moves.

The cursor can be moved in the same way using the <◀> or <▶> buttons.

4. Press the <○> button.

The sub-menu of the selected item is displayed.

(Some sub-menu items have a sub-menu of their own.)

5. Press the <▲> or <▼> button to bring the cursor to the item to be set.

Each time the <▲> or <▼> button is pressed, the cursor moves.

The cursor can be moved in the same way using the <◀> or <▶> button.

With the cursor at the [Return] position, press the <○> button to return to the previous menu.

6. Press the <○> button.

The value of the item to be set starts blinking.

7. Press the <▲> or <▼> button to change the setting.

The setting can be changed in the same way using the <◀> or <▶> button.

8. Press the <○> button.

The value of the item to be set is entered, and it stops blinking.

9. After the setting has been completed, press the <MENU> button for about 2 seconds.

The camera menu display is exited.

Camera menu items

Setting the camera menu items

Camera menus are displayed on the monitor when the unit's settings are to be selected.

The monitor is connected to the MONITOR OUT connector <MONI OUT>.

The camera menu is only displayed from <MONI OUT> in the factory default settings, so the OSD menus are not displayed in <12G SDI>, <3G SDI>, <OPTICAL>, and <HDMI> outputs.

To output the OSD menu via these output connectors, change the settings for [OSD Mix] in [Output].

The basic camera menu operations involve displaying sub-menus from the Top Menu items, and selecting settings on the sub-menus.

Some sub-menus have menu items for performing more detailed settings.

The “*” and “#” marks in the menu titles indicate the hierarchical level of the menu currently displayed.

For instance, “* Top Menu *” indicates the first hierarchical level whereas “** Camera **” and “## System ##” indicate that the second hierarchical level is now displayed.

Menu items accompanied by a “*” mark indicate data which is stored on a scene by scene basis; menu items accompanied by a “#” mark indicate data which is stored together for one camera regardless of the scenes.

For details on factory default settings, see “Camera menu item table” (→ page 79).

<NOTE>

- While the camera menu is displayed, and [Serial] or [IP] of [Tracking Data Output] is set to [On], the tracking data output may be delayed or the value may not be updated. (→ page 61)

Top Menu screen

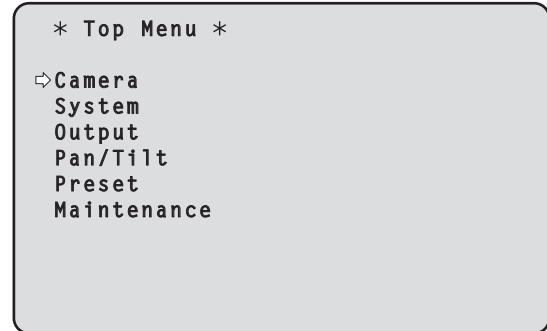

Camera

Select this to open the camera menu relating to the camera images.

System

Select this to display the System menu used to set up system format of the camera or adjust the genlock (external synchronization) phase or establish the camera output image settings.

Output

Select this to display the Output menu used for setting video/audio output for the camera, OSD output, etc.

Pan/Tilt

Select this to display the Pan/Tilt menu used for various pan/tilt operations.

Preset

Select this to display the Preset menu used for various preset playback operations.

Maintenance

Select this to display the Maintenance menu used to check the camera's firmware version or initialize its settings.

<NOTE>

- The Top Menu does not have a [Return].

Camera menu items (continued)

Camera screen

This menu is used for the camera image settings.

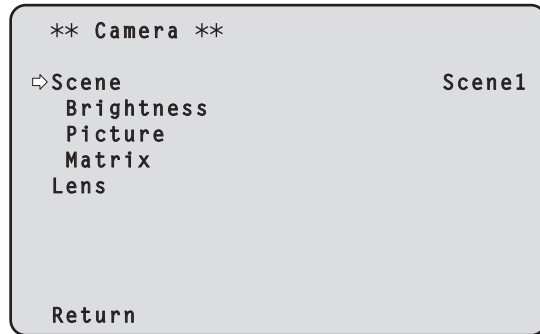

Scene [Scene1, Scene2, Scene3, Scene4]

Selected here is the shooting mode that matches the shooting situation.

Select the mode which best suits the prevailing shooting conditions and the user's preferences.

Scene1	Modes that allow you to adjust detailed settings manually for various shooting conditions and preferences.
Scene2	
Scene3	
Scene4	

Brightness

This menu item displays the Brightness screen on which to set the brightness of the images.

Picture

This menu item displays the Picture screen on which to adjust the picture quality.

Matrix

This menu item displays the Matrix screen on which to set the color matrix.

Lens

This menu item displays the Lens screen for making lens settings.

Return

Return to the previous menu level.

Brightness 1/2 screen

This menu item is selected to set the brightness of the pictures.

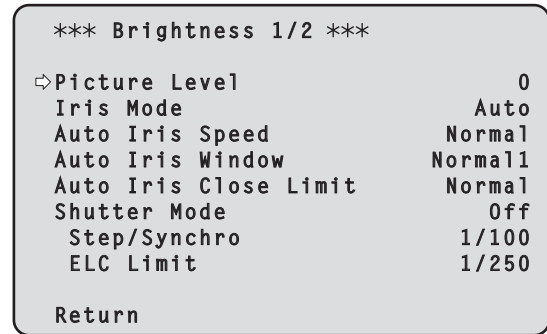

Picture Level [-50 to +50]

This menu item is selected to set the target picture level for automatic exposure compensation.

Its setting takes effect when [Auto] or [ELC] has been selected as the setting for any of the following automatic exposure compensation functions.

- When [Iris Mode] is set to [Auto]
- When [Shutter Mode] is set to [ELC]
- When [Gain] is set to [Auto]

Iris Mode [Manual, Auto]

This menu item is used to select whether the iris is to be adjusted automatically or manually.

Manual	The iris is adjusted manually.
Auto	Auto exposure compensation is performed so that the target level which was set using [Picture Level] is reached.

Auto Iris Speed [Slow, Normal, Fast]

Set the control speed of the auto iris function.

Slow	Control the iris at a slow speed.
Normal	Control the iris at a normal speed.
Fast	Control the iris at a fast speed.

Auto Iris Window [Normal1, Normal2, Center]

Select the detection window for the auto iris.

Normal1	Window towards the center of the screen.
Normal2	Window towards the bottom of the screen.
Center	Spotted window in the center of the screen.

Auto Iris Close Limit [Normal, F8, F7, F5.6]

Sets the limit value for the CLOSE side in auto iris.

Normal	Moves up to the normal position (the vicinity of F9).
F8	The limit is in the vicinity of F8.
F7	The limit is in the vicinity of F7.
F5.6	The limit is in the vicinity of F5.6.

Camera menu items (continued)

Shutter Mode [Off, Step, Synchro, ELC]

Select for camera shutter mode.

Off	The shutter is set to OFF.
Step	The step shutter is set (the steps can be changed).
Synchro	The synchro shutter is set (the setting can be changed continuously).
ELC	The electronic shutter is controlled and the light quantity is adjusted automatically.

Step/Synchro

This is used to adjust the shutter speed in the mode which was selected as the [Shutter Mode] setting.

When a higher shutter speed is selected, fast-moving subjects do not become blurred easily but the images will be darker.

The shutter speeds that can be set are listed below.

	When [Step] is selected as the [Shutter Mode]	When [Synchro] is selected as the [Shutter Mode]
59.94p/59.94i mode	1/60, 1/100, 1/120, 1/250, 1/500, 1/1000, 1/2000, 1/4000, 1/8000, 1/10000	60.0 Hz to 7200 Hz
29.97p mode	1/30, 1/60, 1/100, 1/120, 1/250, 1/500, 1/1000, 1/2000, 1/4000, 1/8000, 1/10000	30.0 Hz to 7200 Hz
23.98p/24p mode	1/24, 1/48, 1/60, 1/100, 1/120, 1/250, 1/500, 1/1000, 1/2000, 1/4000, 1/8000, 1/10000	24.0 Hz to 7200 Hz
50p/50i mode	1/60, 1/100, 1/120, 1/250, 1/500, 1/1000, 1/2000, 1/4000, 1/8000, 1/10000	50.0 Hz to 7200 Hz
25p mode	1/25, 1/50, 1/60, 1/100, 1/120, 1/250, 1/500, 1/1000, 1/2000, 1/4000, 1/8000, 1/10000	25.0 Hz to 7200 Hz

<NOTE>

- When [Shutter Mode] is set to [Off] in 29.97p, 23.98p/24p, or 25p mode, the shutter speed is set to [1/50].

ELC Limit [1/100, 1/120, 1/250]

Set the maximum shutter level when ELC is operating.

Return

Return to the previous menu level.

Brightness 2/2 screen

*** Brightness 2/2 ***	
⇨ Gain	0dB
Super Gain	Off
AGC Max Gain	18dB
Frame Mix	Off
ND Filter	Through
Day/Night	Day
Return	

Gain

[When [Super Gain] is [Off]: Auto, -3dB to 36dB,
When [Super Gain] is [On]: Auto, -3dB to 42dB]

The image gain is adjusted here.

In locations which are too dark, adjust the gain upward; conversely, in locations which are too bright, adjust it downward.

When [Auto] is set, the light quantity is adjusted automatically.

The noise increases when the gain is increased.

Super Gain [Off, On]

Set the super gain (increased sensitivity) mode.

Off	Do not set super gain mode.
On	Set super gain mode.

AGC Max Gain [6dB, 12dB, 18dB]

When [Auto] is selected as the [Gain] setting, the maximum gain-up amount can be set.

Frame Mix [Off, 6dB, 12dB, 18dB, 24dB]

Select for frame addition (gain-up using sensor storage) amount.

Its setting takes effect when [Off] has been selected as the [Shutter Mode] setting.

When frame addition is performed, it will appear as if the images are missing some frames.

This cannot be configured when the format is 2160/29.97p, 2160/23.98p, 2160/24p, 2160/25p, 1080/29.97p, 1080/23.98p(59.94i), 1080/23.98p, 1080/24p, 1080/29.97PsF, 1080/23.98PsF, 1080/25p or 1080/25PsF.

<NOTE>

- Under discharge tube illumination, such as fluorescent and mercury-vapor lights, the brightness may change synchronously, colors may change, and horizontal stripes may flow up and down the image.

Camera menu items (continued)

ND Filter [Through, 1/4, 1/16, 1/64]

Set the transmittance of the lens' built-in ND (neutral density) filter. The filter switches when the setting is fixed.

Through	Do not set ND filter.
1/4	Set ND filter transmittance to 1/4.
1/16	Set ND filter transmittance to 1/16.
1/64	Set ND filter transmittance to 1/64.

Day/Night

[Day, Night]

Switch between standard shooting and night-vision shooting (shooting with infrared light).

Day	Standard shooting (day mode)
Night	Night-vision shooting (night mode)

This cannot be set when the [Color Setting] is [V-Log].

<NOTE>

- In night mode, video output will be in black and white. In addition, the iris will be forcibly opened.
- White balance adjustment is not possible in night mode.
- ND filter switching is not possible in night mode.
- [Pedestal] cannot be performed properly in night mode.

Return

Return to the previous menu level.

Picture 1/8 screen

*** Picture 1/8 ***	
◁ White Balance Mode	AWB A
Color Temperature	3200K
R Gain	0
B Gain	0
Color TEMP. Setting	
AWB Gain Offset	Off
ATW Speed	Normal
ATW Target R	0
ATW Target B	0
Return	

White Balance Mode

[ATW, AWB A, AWB B, 3200K, 5600K, VAR]

Set the white balance mode.

Select the mode when the coloring is not natural because of the nature of the light source or other factors.

If the white color serving as the reference can be recognized, subjects can be shot with natural coloring.

ATW	In this mode, the white balance is compensated for automatically, even if changes occur in the light source or color temperature, by a process of continuous and automatic adjustment.
AWB A AWB B	When [AWB A] or [AWB B] is selected and the white balance is executed, the adjustment results obtained are stored in the memory selected. When [AWB A] or [AWB B] is then selected, the white balance stored in the selected memory can be recalled.
3200K	This is the white balance mode which is ideal when a 3200K halogen light is used as the light source.
5600K	This is the white balance mode which is ideal when 5600K sunlight or fluorescent lighting is used as the light source.
VAR	You can specify a color temperature between 2000K to 15000K.

Color Temperature [2000K to 15000K]

You can specify a color temperature between 2000K to 15000K. Its setting takes effect when [VAR] has been selected as the [White Balance Mode] setting.

R Gain [-200 to +200]

This enables the R gain to be adjusted.

Its setting takes effect when [AWB A], [AWB B] or [VAR] has been selected as the [White Balance Mode] setting.

B Gain [-200 to +200]

This enables the B gain to be adjusted.

Its setting takes effect when [AWB A], [AWB B] or [VAR] has been selected as the [White Balance Mode] setting.

Color TEMP. Setting

This opens the advanced setting screen when [White Balance Mode] is [AWB A] or [AWB B]. (→ page 49)

AWB Gain Offset [Off, On]

When auto white balance is performed by setting [White Balance Mode] to [AWB A] or [AWB B], set the values for Rch gain and Bch gain.

Off	Set the value of [R Gain] and [B Gain] to [0].
On	Maintain the value set in [R Gain] and [B Gain].

Camera menu items (continued)

ATW Speed [Normal, Slow, Fast]

Set the control speed of the ATW function.

Normal	Tracks at normal speed.
Slow	Tracks at a speed slower than [Normal].
Fast	Tracks at a speed faster than [Normal].

This is only enabled when [White Balance Mode] is set to [ATW].

ATW Target R [-10 to +10]

Make fine adjustments to the Rch output when converging with the auto tracking white balance operation.

ATW Target B [-10 to +10]

Make fine adjustments to the Bch output when converging with the auto tracking white balance operation.

Return

Return to the previous menu level.

Color TEMP. Setting screen

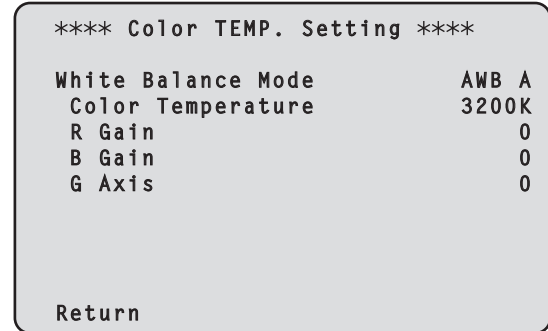

White Balance Mode [ATW, AWB A, AWB B, 3200K, 5600K, VAR]

This displays the values for the [White Balance Mode] in the [Picture 1/8] screen.

<NOTE>

- This item only displays the setting value. You cannot change the setting value here.

To change the setting value, go to [White Balance Mode] in the [Picture 1/8] screen.

Color Temperature [2000K to 15000K]

This displays the color temperature when [White Balance Mode] is [AWB A] or [AWB B].

Varying the output balance of Rch and Bch enables the varying of the color temperature.

Varying [R Gain] and [B Gain] in [Color TEMP. Setting] also enables color temperature adjustments.

Its setting takes effect when [AWB A] or [AWB B] has been selected as the [White Balance Mode] setting.

R Gain [-400 to +400]

This enables adjustments to R Gain when [White Balance Mode] is [AWB A] or [AWB B].

Varying the output of Rch enables the varying of the colors on the Rch axis.

Its setting takes effect when [AWB A] or [AWB B] has been selected as the [White Balance Mode] setting.

B Gain [-400 to +400]

This enables adjustments to B Gain when [White Balance Mode] is [AWB A] or [AWB B].

Varying the output of Bch enables the varying of the colors on the Bch axis.

Its setting takes effect when [AWB A] or [AWB B] has been selected as the [White Balance Mode] setting.

G Axis [-400 to +400]

This enables adjustments to G Axis when [White Balance Mode] is [AWB A] or [AWB B].

Varying the output of Rch and Bch enables the varying of the colors on the G axis.

Its setting takes effect when [AWB A] or [AWB B] has been selected as the [White Balance Mode] setting.

Return

Return to the previous menu level.

Picture 2/8 screen

*** Picture 2/8 ***	
◁ Chroma Level	0%
Chroma Phase	0
Master Pedestal	0
R Pedestal	0
G Pedestal	0
B Pedestal	0
Pedestal Offset	Off
Return	

Chroma Level [Off, -99% to 99%]

Set here the color intensity (chroma level) of the images.
This cannot be set when the [Color Setting] is [V-Log].

Chroma Phase [-31 to +31]

Make fine adjustments to the hue of the colors in the images.
This cannot be set when the [Color Setting] is [V-Log].

Master Pedestal [-200 to +200]

This item is used to adjust the black level (adjust the pedestal).
These parts become darker when a negative setting is selected and, conversely, lighter when a positive setting is selected.
This cannot be set when the [Color Setting] is [V-Log].
All of the following Master Pedestal items also cannot be set when [Color Setting] is [V-Log].

R Pedestal [-100 to +100]

This enables the R pedestal to be adjusted.

G Pedestal [-100 to +100]

This enables the G pedestal to be adjusted.

B Pedestal [-100 to +100]

This enables the B pedestal to be adjusted.

Pedestal Offset [Off, On]

Set the pedestal level of the Rch, Gch, and Bch when the auto black balance has been adjusted.

Off	Set the pedestal level to [0] for [R Pedestal], [G Pedestal], and [B Pedestal].
On	Maintain the values set for each of [R Pedestal], [G Pedestal], and [B Pedestal].

Return

Return to the previous menu level.

Picture 3/8 screen

*** Picture 3/8 ***	
◁ Detail	On
Master Detail	0
Detail Coring	15
V Detail Level	0
Detail Frequency	0
Level Depend.	0
Knee Aperture Level	2
Detail Gain(+)	0
Detail Gain(-)	0
Return	

Detail [Off, On]

Turn on/off the contour (sharpness of images) adjustment of images.
This cannot be set when the [Color Setting] is [V-Log].
All of the following Detail items also cannot be set when [Color Setting] is [V-Log].

Master Detail [-31 to +31]

Adjust the contour correction level (master).
This is only enabled when [Detail] is set to [On].

Detail Coring [0 to 60]

Set the level of the signal (including noise) which makes the detail effect not work.
This is only enabled when [Detail] is set to [On].

V Detail Level [-7 to +7]

Adjust the contour correction level in the vertical direction.
This is only enabled when [Detail] is set to [On].

Detail Frequency [-7 to +7]

Set the boost frequency of detail.

-7: Low frequency
to
+7: High frequency

When a high frequency is selected, the detail effect is added to subjects with more definition.
This is only enabled when [Detail] is set to [On].

Level Depend. [-7 to +7]

When the detail of bright signals are emphasized, the detail of dark parts are compressed.
The larger the [Level Depend.] setting, the more detail of bright parts is compressed.
This is only enabled when [Detail] is set to [On].

Knee Aperture Level [0 to 5]

Set the detail level of very bright parts.
This is only enabled when [Detail] is set to [On].

Detail Gain(+) [-31 to +31]

Set the detail level of the plus direction (direction to be made brighter).
This is only enabled when [Detail] is set to [On].

Detail Gain(-) [-31 to +31]

Set the detail level of the minus direction (direction to be made darker).
This is only enabled when [Detail] is set to [On].

Return

Return to the previous menu level.

Picture 4/8 screen

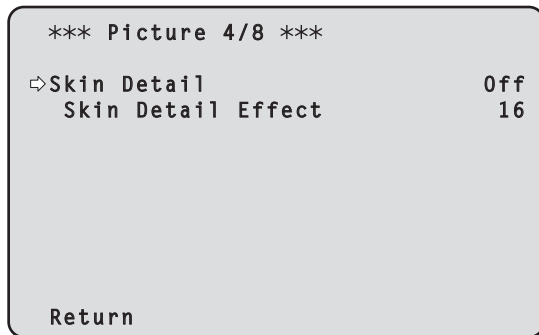

Skin Detail [Off, On]

This function smooths skin and produces a more beautiful image. This is only enabled when [Detail] is set to [On]. This cannot be set when the [Color Setting] is [V-Log]. All of the following Skin Detail items also cannot be set when [Color Setting] is [V-Log].

Skin Detail Effect [0 to 31]

The skin of human subjects appears smoother the larger the setting value. This is only enabled when [Detail] is set to [On] and [Skin Detail] is set to [On].

Return

Return to the previous menu level.

Picture 5/8 screen

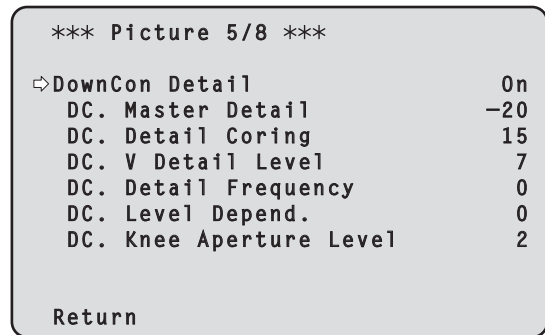

DownCon Detail [Off, On]

Turn on/off the contour (sharpness of images) adjustment of images down-converted from 4K to HD.

This is enabled when [Format] is the following.

- 2160/59.94p, 2160/29.97p, 2160/23.98p, 2160/24p, 2160/50p, 2160/25p

This cannot be set when the [Color Setting] is [V-Log].

All of the following DownCon Detail items also cannot be set when [Color Setting] is [V-Log].

DC. Master Detail [-31 to +31]

Adjust the contour correction level (master) for images down-converted from 4K to HD.

This is enabled when [Format] is the following.

- 2160/59.94p, 2160/29.97p, 2160/23.98p, 2160/24p, 2160/50p, 2160/25p

This is only enabled when [DownCon Detail] is set to [On].

DC. Detail Coring [0 to 60]

Set the level of the signal (including noise) which makes the detail effect not work for images down-converted from 4K to HD.

This is enabled when [Format] is the following.

- 2160/59.94p, 2160/29.97p, 2160/23.98p, 2160/24p, 2160/50p, 2160/25p

This is only enabled when [DownCon Detail] is set to [On].

DC. V Detail Level [-7 to +7]

Adjust the contour correction level in the vertical direction for images down-converted from 4K to HD.

This is enabled when [Format] is the following.

- 2160/59.94p, 2160/29.97p, 2160/23.98p, 2160/24p, 2160/50p, 2160/25p

This is only enabled when [DownCon Detail] is set to [On].

DC. Detail Frequency [-2 to +2]

Set the boost frequency of detail for images down-converted from 4K to HD.

- 2: Low frequency
- to
- +2: High frequency

When a high frequency is selected, the detail effect is added to subjects with more definition.

This is enabled when [Format] is the following.

- 2160/59.94p, 2160/29.97p, 2160/23.98p, 2160/24p, 2160/50p, 2160/25p

This is only enabled when [DownCon Detail] is set to [On].

DC. Level Depend. [-7 to +7]

The larger the setting for images down-converted from 4K to HD, the more detail of bright parts is compressed.

This is enabled when [Format] is the following.

- 2160/59.94p, 2160/29.97p, 2160/23.98p, 2160/24p, 2160/50p, 2160/25p

This is only enabled when [DownCon Detail] is set to [On].

DC. Knee Aperture Level [0 to 5]

Set the detail level of very bright parts in images down-converted from 4K to HD.

This is enabled when [Format] is the following.

- 2160/59.94p, 2160/29.97p, 2160/23.98p, 2160/24p, 2160/50p, 2160/25p

This is only enabled when [DownCon Detail] is set to [On].

Return

Return to the previous menu level.

Picture 6/8 screen

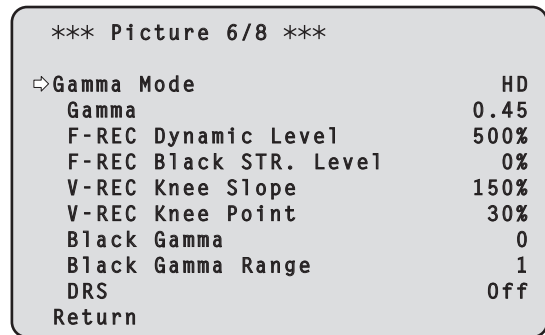

Gamma Mode

[HD, FILMLIKE1, FILMLIKE2, FILMLIKE3, FILM REC, VIDEO REC, HLG]

Select the type of gamma curve.

HD	HD (High Definition) video gamma characteristic.
FILMLIKE1	Characteristic capable of reproducing better gradation in highlights than HD gamma.
FILMLIKE2	Characteristic capable of reproducing better gradation in highlights than [FILMLIKE1].
FILMLIKE3	Characteristic capable of reproducing better gradation in highlights than [FILMLIKE2].
FILM REC	Cinema film gamma characteristic.
VIDEO REC	Cinema video gamma characteristic.
HLG	Hybrid Log Gamma characteristic.

This cannot be set when the [Color Setting] is [V-Log].

All of the following Gamma Mode items also cannot be set when [Color Setting] is [V-Log].

<NOTE>

- When [Gamma Mode] is changed from [HLG] to a mode other than [HLG], or when changed to [HLG], IP video transmission is temporarily stopped.

Gamma [0.30 to 0.75]

Adjust the gamma correction level.

Specifying smaller values results in a gentler gamma curve for the slope of low-brightness areas and sharper contrast.

Specifying larger values results in an expanded gradient for dark areas and produces brighter images. The gamma curve for low-brightness areas will be steeper, and contrast will be softer.

This is only enabled when [Gamma Mode] is set to other than [HLG].

F-REC Dynamic Level [200%, 300%, 400%, 500%, 600%]

Set the dynamic range.

This is only enabled when [Gamma Mode] is set to [FILM REC].

F-REC Black STR. Level [0% to 30%]

Set the black stretch.

This is only enabled when [Gamma Mode] is set to [FILM REC].

V-REC Knee Slope [150%, 200%, 250%, 300%, 350%, 400%, 450%, 500%]

Set the knee slope.

This is only enabled when [Gamma Mode] is set to [VIDEO REC].

V-REC Knee Point [30% to 107%]

Set the knee point.

This is only enabled when [Gamma Mode] is set to [VIDEO REC].

Camera menu items (continued)

Black Gamma [-8 to +8]

Set the gamma curve for dark areas.

-8 to -1	Compresses dark parts.
1 to 8	Expands dark parts.

Black Gamma Range [1 to 3]

Set the maximum level of compression/expansion.

1	Around 20%
2	Around 30%
3	Around 40%

DRS [Off, Low, Mid, High]

Set the DRS function which performs correction when video with high light/dark contrast is displayed.

You can select from a [Low], [Mid], or [High] effect level.

This is only enabled when [Gamma Mode] is set to other than [HLG].

Return

Return to the previous menu level.

Picture 7/8 screen

*** Picture 7/8 ***	
⇨ Knee Mode	Auto
Auto Knee Response	4
Knee Point	93.0%
Knee Slope	99
HLG Knee	Off
HLG Knee Point	55%
HLG Knee Slope	10
Return	

Knee Mode [Off, Auto, Manual]

Set the operating mode for gradation compression (knee).

Off	Turn the knee function off.
Auto	Enable the knee function, and set the knee point and knee slope automatically.
Manual	Enable the knee function, and set the knee point and knee slope manually.

This is only enabled when [Gamma Mode] is set to other than [HLG].

This cannot be set when the [Color Setting] is [V-Log].

All of the following Knee Mode items also cannot be set when [Color Setting] is [V-Log].

Auto Knee Response [1 to 8]

Set the speed of the auto knee response.

The response speed increases the lower the setting value.

This is only enabled when [Gamma Mode] is set to other than [HLG].

Knee Point [70.0% to 107.0%]

Set the compression level (knee point) position for high-brightness video signals.

This is only enabled when [Gamma Mode] is set to other than [HLG].

This is only enabled when [Knee Mode] is set to [Manual].

Knee Slope [0 to 99]

Set the knee slope.

This is only enabled when [Gamma Mode] is set to other than [HLG].

This is only enabled when [Knee Mode] is set to [Manual].

<NOTE>

- When [DRS] is enabled, the knee setting is disabled.

HLG Knee [Off, On]

Enable or disable the operation of the HLG knee.

This is only enabled when [Gamma Mode] is set to [HLG].

This cannot be set when the [Color Setting] is [V-Log].

All of the following HLG Knee items also cannot be set when [Color Setting] is [V-Log].

HLG Knee Point [55% to 100%]

Set the position of the HLG knee point.

This is only enabled when [Gamma Mode] is set to [HLG].

HLG Knee Slope [0 to 100]

Set the slope of the HLG knee.

This is only enabled when [Gamma Mode] is set to [HLG].

Return

Return to the previous menu level.

Picture 8/8 screen

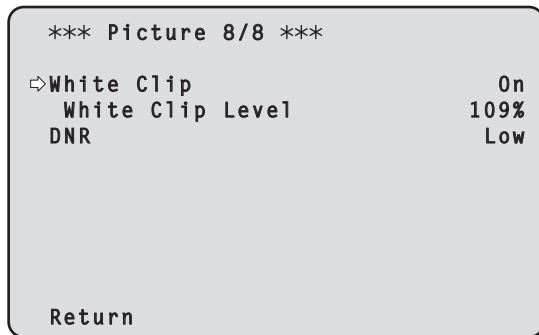

White Clip [Off, On]

Turn the white clip function off/on.
 This is only enabled when [Gamma Mode] is set to other than [HLG].
 This cannot be set when the [Color Setting] is [V-Log].
 All of the following White Clip items also cannot be set when [Color Setting] is [V-Log].

White Clip Level [90% to 109%]

Set the white clip level.
 This is only enabled when [Gamma Mode] is set to other than [HLG].
 This is only enabled when [White Clip] is set to [On].

<NOTE>

- When [Knee Mode] is set to [Auto] and the value of [White Clip Level] is changed, the knee value will also change.

DNR [Off, Low, High]

Set the digital noise reduction level for outputting bright, clear images without noise, even at night and low-light conditions.
 When [Low] or [High] is selected, noise can be eliminated.
 However, image lag may increase.

Return

Return to the previous menu level.

Matrix 1/5 screen

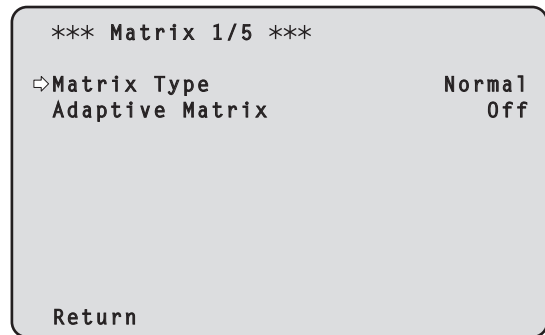

Matrix Type [Normal, EBU, NTSC, User]

Select the type of color matrix.

Normal	This item is used to load the preset color matrix data and compensate for the saturation and color phase.
EBU	
NTSC	
User	On the [Matrix 2/5] screen, the [Linear Matrix] value can be adjusted by the user. On the [Matrix 3/5] screen, [Matrix 4/5] screen or [Matrix 5/5] screen, the [Color Correction] value can be adjusted by the user.

This cannot be set when the [Color Setting] is [V-Log].

Adaptive Matrix [Off, On]

Set Off/On the function that suppresses the linear matrix to suit the shooting conditions.
 This cannot be set when the [Color Setting] is [V-Log].

Return

Return to the previous menu level.

Matrix 2/5 screen

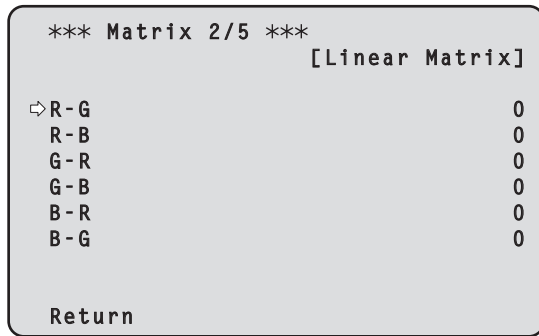

Linear Matrix

This can be set when [User] has been selected as the [Matrix Type] setting.

R-G	Adjust the color to between -63 and +63 for each axis direction.
R-B	
G-R	
G-B	
B-R	
B-G	

This cannot be set when the [Color Setting] is [V-Log].

Return

Return to the previous menu level.

Matrix 3/5 screen

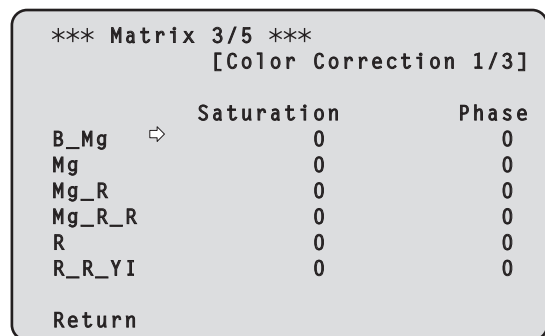

Color Correction 1/3

This can be set when [User] has been selected as the [Matrix Type] setting.

Adjust the saturation and hue.

This cannot be set when the [Color Setting] is [V-Log].

All of the following Color Correction items also cannot be set when [Color Setting] is [V-Log].

Saturation [-63 to +63]

Adjust the saturation for each color.

Phase [-63 to +63]

Adjust the hue for each color.

B_Mg	Color between blue and magenta
Mg	Magenta
Mg_R	Color between magenta and red
Mg_R_R	Color with a 1:3 magenta to red ratio
R	Red
R_R_YI	Color with a 3:1 red to yellow ratio

Return

Return to the previous menu level.

Matrix 4/5 screen

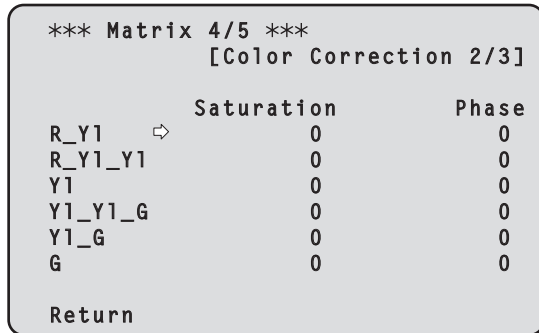

Color Correction 2/3

This can be set when [User] has been selected as the [Matrix Type] setting.

Adjust the saturation and hue.

This cannot be set when the [Color Setting] is [V-Log].

All of the following Color Correction items also cannot be set when [Color Setting] is [V-Log].

Saturation [-63 to +63]

Adjust the saturation for each color.

Phase [-63 to +63]

Adjust the hue for each color.

R_Y1	Color between red and yellow
R_Y1_Y1	Color with a 1:3 red to yellow ratio
Y1	Yellow
Y1_Y1_G	Color with a 3:1 yellow to green ratio
Y1_G	Color between yellow and green
G	Green

Return

Return to the previous menu level.

Matrix 5/5 screen

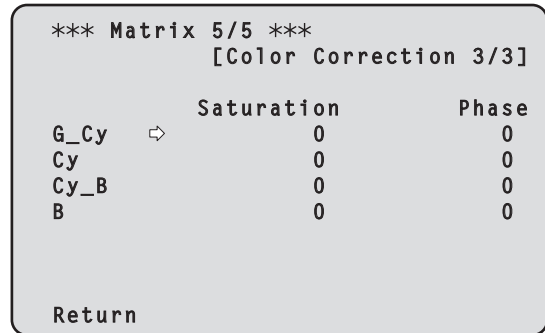

Color Correction 3/3

This can be set when [User] has been selected as the [Matrix Type] setting.

Adjust the saturation and hue.

This cannot be set when the [Color Setting] is [V-Log].

All of the following Color Correction items also cannot be set when [Color Setting] is [V-Log].

Saturation [-63 to +63]

Adjust the saturation for each color.

Phase [-63 to +63]

Adjust the hue for each color.

G_Cy	Color between green and cyan
Cy	Cyan
Cy_B	Color between cyan and blue
B	Blue

Return

Return to the previous menu level.

Lens screen

### Lens ###	
⇨ Focus Mode	Auto
Zoom Mode	Opt.Zoom
Max Digital Zoom	x10
Digital Extender	Off
OIS	Off
Return	

Focus Mode [Auto, Manual]

Select auto or manual mode for the focus adjustment function.

Auto	Always adjust focus automatically.
Manual	Adjust focus manually.

Zoom Mode [Opt.Zoom, i.Zoom, D.Zoom]

Set the maximum magnification rate for zoom.

Opt.Zoom	Use only optical zoom. Optical zoom up to 20× is possible.
i.Zoom	Enable the i.Zoom function. When this function is enabled, digital zoom is used while reducing image degradation. When [Format] in the [System 1/2] screen is 2160/59.94p, 2160/29.97p, 2160/50p, 2160/25p, 2160/24p, 2160/23.98p Up to 24× zoom is possible combining optical zoom and digital zoom. • When [Format] in the [System 1/2] screen is other than one of these, up to 32× zoom is possible combining optical zoom and digital zoom.
D.Zoom	Enable the digital zoom function. Higher digital zoom magnifications will result in coarser images.

Max Digital Zoom

[x2, x3, x4, x5, x6, x7, x8, x9, x10]

Set the maximum digital zoom magnification.

This is only enabled when [Zoom Mode] is set to [D.Zoom].

<NOTE>

- Higher digital zoom magnifications will result in coarser images.

Digital Extender [Off, x1.4, x2.0]

Make settings for the digital extender function.

Off	Turn the digital extender function off.
x1.4	The digital zoom will be fixed at 1.4×.
x2.0	The digital zoom will be fixed at 2.0×.

This is only enabled when [Zoom Mode] is set to [Opt.Zoom].

OIS [Off, On]

Turn the optical image stabilization (OIS) function off/on.

<NOTE>

- The optical image stabilization (OIS) function's level of correction is reduced during pan/tilt operations.

Return

Return to the previous menu level.

System 1/2 screen

## System 1/2 ##	
⇨ Frequency	59.94Hz
Format	2160/59.94p
Shooting Mode	Normal
Color Setting	Normal
Genlock	
Horizontal Phase	0
Return	

Frequency [59.94Hz, 50Hz, 24Hz, 23.98Hz]

This item is selected to switch the frame frequency.

- For details on how to change the frequency, refer to "Changing the frequency" (→ page 60).

Format

For [59.94Hz]

2160/59.94p, 2160/29.97p, 1080/59.94p, 1080/59.94i, 1080/29.97p, 1080/29.97PsF, 1080/23.98p(59.94i) *1, 720/59.94p

For [50Hz]

2160/50p, 2160/25p, 1080/50p, 1080/50i, 1080/25p, 1080/25PsF, 720/50p

For [24Hz]

2160/24p, 1080/24p

For [23.98Hz]

2160/23.98p, 1080/23.98p, 1080/23.98PsF

*1 It denotes "1080/23.98p over 59.94i".

<NOTE>

- Streaming stops when changing the system format.
- For details on how to change the format, refer to "Changing the format" (→ page 60).

Shooting Mode [Normal, High Sens.]

Select the shooting mode according to the shooting environment.

Normal	Select when shooting in an environment with a normal level of brightness.
High Sens.	Select high sensitivity shooting. (Suited to shooting in a dark environment)

Color Setting [Normal, V-Log]

Set the color (gamma and gamut) for the system as a whole.

Normal	This setting allows detailed picture quality adjustments on the camera.
V-Log	Set a gamma curve that provides tones and a wide range of latitude (exposure range).

<NOTE>

- Functions to adjust picture quality are limited when [Color Setting] is [V-Log]. Grading will be necessary after shooting.

Genlock

This item is selected to perform the phase adjustments.

Horizontal Phase [-206 to +49]

This is used to adjust the horizontal phase during genlock.

Return

Return to the previous menu level.

System 2/2 screen

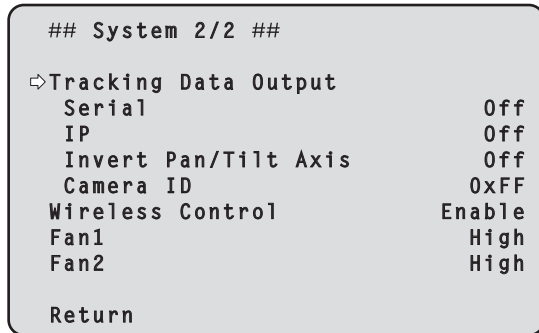

Tracking Data Output

Settings for the output of tracking data to be used in a virtual studio system or elsewhere. (→ page 61)

Serial [Off, On]

Sets the function [On] or [Off] to output the tracking data, such as Pan/Tilt/Zoom or other information from Serial Output (RS-422), synchronized with the Genlock signal. (→ page 61)

<NOTE>

- The serial connection of the remote controller (AW-RP150, etc.) cannot be made if [Serial] is already [On].
- In the following cases, the tracking data output may be delayed or the value may not be updated.
 - While viewing the OSD menu
 - While recalling the preset value during an ongoing preset recall
 - When executing AWB/ABB
 - When a red or a green tally signal input has been changed between Off and On
 - When deleting a preset memory
 - When an output image is flipped (turned upside down or left-right reversed)
 - After switching [Scene]
 - After switching [Iris Mode]
 - After switching [Super Gain]
 - After switching [White Balance Mode]
 - After switching each item of [Color TEMP. Setting]
 - After switching [Gamma Mode]
 - After switching [Matrix Type]
 - After switching [Focus Mode]
 - After switching [Zoom Mode]
 - After switching [Max Digital Zoom]
 - After switching [Digital Extender]
 - After switching between [Fan1] and [Fan2]
 - After switching [OSD Mix]
 - After switching [Tally]
 - After moving the crop frame of [UHD Crop]
 - After switching [Install Position]
 - After switching [Preset Speed Unit]
 - When executing [Initialize] of [Maintenance]

IP [Off, On]

Sets the UDP output function [On] or [Off] to output tracking data, such as Pan/Tilt/Zoom or other information from the IP output, synchronized with the Genlock signal. (→ page 62)

<NOTE>

- When [IP] is [On], video transmission via IP may be delayed or the video may suffer frame loss.
 - We recommend setting [IP] to [Off] to avoid the delay or frame loss due to the video transmission via IP.
- In the following cases, the tracking data output may be delayed or the value may not be updated.
 - When performing video transmission via IP (M-JPEG/H.264/H.265/RTMP/RTMPS/NDI|HX/SRT)
 - When opening the web screen (live screen [Live] or the web setting screen [Setup])
 - While viewing the OSD menu
 - While recalling the preset value during an ongoing preset recall
 - When executing AWB/ABB
 - When a red or a green tally signal input has been changed between Off and On
 - When deleting a preset memory
 - When an output image is flipped (turned upside down or left-right reversed)
 - After switching [Scene]
 - After switching [Iris Mode]
 - After switching [Super Gain]
 - After switching [White Balance Mode]
 - After switching each item of [Color TEMP. Setting]
 - After switching [Gamma Mode]
 - After switching [Matrix Type]
 - After switching [Focus Mode]
 - After switching [Zoom Mode]
 - After switching [Max Digital Zoom]
 - After switching [Digital Extender]
 - After switching between [Fan1] and [Fan2]
 - After switching [OSD Mix]
 - After switching [Tally]
 - After moving the crop frame of [UHD Crop]
 - After switching [Install Position]
 - After switching [Preset Speed Unit]
 - When executing [Initialize] of [Maintenance]

Invert Pan/Tilt Axis [Off, On]

Sets whether to invert the Pan/Tilt data for output in the tracking data.

Off	Pan/Tilt data is not inverted.
On	Pan/Tilt data is inverted for output.

Camera ID [0x00 to 0xFF]

Sets the Camera ID for tracking data.

Camera menu items (continued)

Wireless Control [Enable, Disable]

[Enable] or [Disable] is set here for operations conducted from the wireless remote control.

<NOTE>

- When the power is turned on with the wireless remote control, then operations from the wireless remote control are possible irrespective of this setting value.

Fan1 [Auto, Low, Mid, High]

Set the operation of the cooling fan near the lens.

Auto	Enable automatic control of the cooling fan.
Low	Operate the cooling fan at low speed.
Mid	Operate the cooling fan at medium speed.
High	Operate the cooling fan at high speed.

<NOTE>

- Even if this is set to [Low], [Mid], or [High], the cooling fan may be forcibly stopped when the temperature is low.
- Even if this is set to [Low] or [Mid], the cooling fan may be forcibly operated at [High] when the temperature is high.

Fan2 [Auto, Low, Mid, High]

Set the operation of the cooling fan near the pan-tilt head.

Auto	Enable automatic control of the cooling fan.
Low	Operate the cooling fan at low speed.
Mid	Operate the cooling fan at medium speed.
High	Operate the cooling fan at high speed.

<NOTE>

- Even if this is set to [Low], [Mid], or [High], the cooling fan may be forcibly stopped when the temperature is low.
- Even if this is set to [Low] or [Mid], the cooling fan may be forcibly operated at [High] when the temperature is high.

Return

Return to the previous menu level.

■ Changing the frequency

When the currently selected frequency is changed in the [System 1/2] screen, the pre-frequency-change confirmation screen appears.

Pre-frequency-change confirmation screen

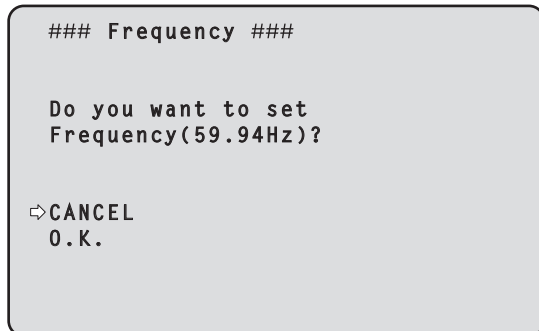

- The frequency to be set is displayed within the parentheses on the screen.
- When you move the cursor to [O.K.] on the pre-frequency-change confirmation screen and confirm, the frequency is changed.

<NOTE>

- When using a monitor that does not support 59.94Hz/50Hz/24Hz/23.98Hz frequencies, images may not be displayed after the frequency is changed. Before changing the frequency, verify that your monitor supports the frequency.
- When Frequency is changed, the unit restarts.

■ Changing the format

When the currently selected format is changed in the [System 1/2] screen, the pre-format-change confirmation screen appears.

Pre-format-change confirmation screen

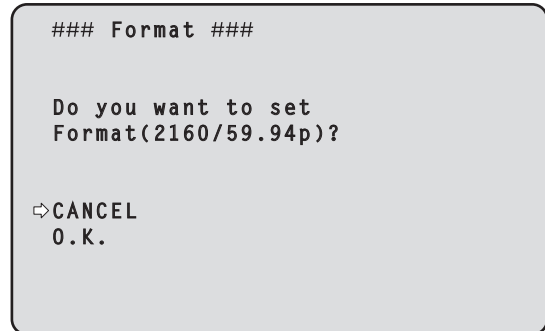

- The format to be set is displayed within the parentheses on the screen.
- When you move the cursor to [O.K.] on the pre-format-change confirmation screen and confirm, the post-format-change confirmation screen appears.

Post-format-change confirmation screen

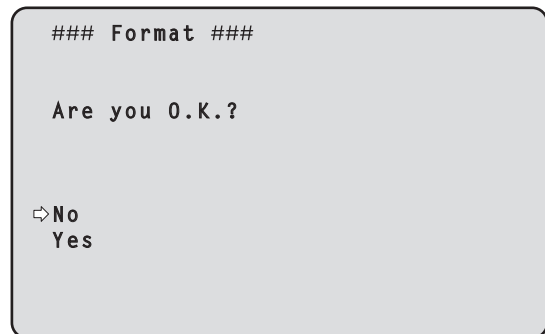

- If you move the cursor to [Yes] and confirm, the display returns to the [System 1/2] screen in the post-change format.
- If you move the cursor to [No] and confirm, the display returns to the [System 1/2] screen in the pre-change format. The same occurs if an operation is not performed within 10 seconds.
- When Format is changed, IP video transmission is stopped.
- When Format is changed, the Format for each output terminal (12G SDI/OPTICAL, 3G SDI, MONI, HDMI) is reset to its predefined value.

■ Tracking data output

When [Serial] or [IP] of [Tracking Data Output] on the [System 2/2] screen is set to [On], outputs the tracking data for Pan/Tilt/Zoom or other information to link with a virtual studio system or elsewhere via serial (RS-422) or IP output.

● Serial (RS-422) output

- When [Serial] of [Tracking Data Output] on the [System 2/2] screen is set to [On], the tracking data for Pan/Tilt/Zoom or other information is synchronized with the Genlock signal and output via the serial output (RS-422).
- The tracking data is output in stream mode in a format conforming to the free-d protocol. The message type is Type D1 (camera position/orientation data) only.

Advanced stored data

This unit stores and outputs the following data according to the packet structure specified in Type D1 of the free-d protocol.

Camera ID

An ID between 00h and FFh can be selected.

Camera Pan Angle

Stores the Pan angle of the unit (–175° to +175°) with the format provided by the free-d protocol.

Camera Tilt Angle

Stores the Tilt angle of the unit (–30° to +210°) with the format provided by the free-d protocol.

<NOTE>

- The range of the angle is limited to between –90° and +90° in the free-d protocol. However, this unit can store greater angles than +90° (up to +210°).

Camera Roll Angle

Stores the rotation angle (0° or 180°) corresponding to the flip state (turned upside down or left-right reversed) of the unit with the format provided by the free-d protocol.

Stores an angle of 180° in the flipped state (turned upside down or left-right reversed) (exceeding the angle specified when [Smart Picture Flip] is [On]), and stores 0° other than in this condition.

Camera X-Position

Always stores 000000h.

Camera Y-Position

Always stores 000000h.

Camera Height (Z-Position)

Always stores 000000h.

Camera Zoom

Stores the magnification of optical zoom of this unit between 000555h (WIDE) and 000FFFh (TELE).

<NOTE>

- The magnification of digital zoom is not stored.

Camera Focus

Stores the value of focus position of this unit between 000555h (NEAR) and 000FFFh (FAR).

Spare / User Defined (16bits)

Stores the value of iris position of this unit between 0555h (CLOSE) and 0FFFh (OPEN).

Checksum

Stores the checksum value provided by the free-d protocol.

<NOTE>

- The serial connection of the remote controller (AW-RP150, etc.) cannot be made if [Serial] is already [On].
- In the following cases, the tracking data output may be delayed or the value may not be updated.
 - While viewing the OSD menu
 - While recalling the preset value during an ongoing preset recall
 - When executing AWB/ABB
 - When a red or a green tally signal input has been changed between Off and On
 - When deleting a preset memory
 - When an output image is flipped (turned upside down or left-right reversed)
 - After switching [Scene]
 - After switching [Iris Mode]
 - After switching [Super Gain]
 - After switching [White Balance Mode]
 - After switching each item of [Color TEMP. Setting]
 - After switching [Gamma Mode]
 - After switching [Matrix Type]
 - After switching [Focus Mode]
 - After switching [Zoom Mode]
 - After switching [Max Digital Zoom]
 - After switching [Digital Extender]
 - After switching between [Fan1] and [Fan2]
 - After switching [OSD Mix]
 - After switching [Tally]
 - After moving the crop frame of [UHD Crop]
 - After switching [Install Position]
 - After switching [Preset Speed Unit]
 - When executing [Initialize] of [Maintenance]

● IP output

- When [IP] of [Tracking Data Output] on the [System 2/2] screen is set to [On], the tracking data for Pan/Tilt/Zoom or other information is synchronized with the Genlock signal and outputs UDP packets via IP.
- Outputs simultaneously up to four clients (IP addresses) that have been specified on the designated web screen (→ page 128).
- The tracking data is output in a format conforming to the free-d protocol. The output specification (mode, command type, advanced stored data) of this unit is equivalent to serial (RS-422) output.

<NOTE>

- When forwarding to more than one client, the timing of transmitting the UDP packet to the second and subsequent client will always be delayed relative to the Genlock signal.
(Approximately 200 to 300 μ s delay will occur for each client. The latency may be increased depending on the system status or the network environment of the unit.)
- When [IP] is [On], video transmission via IP may be delayed or the video may suffer frame loss.
We recommend setting [IP] to [Off] to avoid the delay or frame loss due to the video transmission via IP.
- In the following cases, the tracking data output may be delayed or the value may not be updated.
 - When performing video transmission via IP (M-JPEG/H.264/H.265/RTMP/RTMPS/NDI|HX/SRT)
 - When opening the web screen (live screen [Live] or the web setting screen [Setup])
 - While viewing the OSD menu
 - While recalling the preset value during an ongoing preset recall
 - When executing AWB/ABB
 - When a red or a green tally signal input has been changed between Off and On
 - When deleting a preset memory
 - When an output image is flipped (turned upside down or left-right reversed)
 - After switching [Scene]
 - After switching [Iris Mode]
 - After switching [Super Gain]
 - After switching [White Balance Mode]
 - After switching each item of [Color TEMP. Setting]
 - After switching [Gamma Mode]
 - After switching [Matrix Type]
 - After switching [Focus Mode]
 - After switching [Zoom Mode]
 - After switching [Max Digital Zoom]
 - After switching [Digital Extender]
 - After switching between [Fan1] and [Fan2]
 - After switching [OSD Mix]
 - After switching [Tally]
 - After moving the crop frame of [UHD Crop]
 - After switching [Install Position]
 - After switching [Preset Speed Unit]
 - When executing [Initialize] of [Maintenance]

Output 1/9 screen

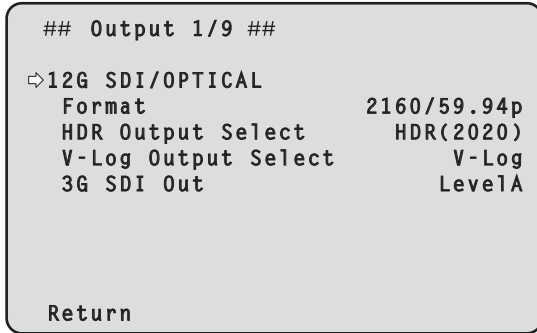

12G SDI/OPTICAL

Make the settings for output from the 12G SDI OUT connector and Optical connector.

Format

Set the output format.

The following format settings are possible depending on the [Format] setting in the [System 1/2] screen.

Frequency	System Format	Format (12G SDI/OPTICAL)
59.94Hz	2160/59.94p	2160/59.94p 1080/59.94p *2
	2160/29.97p	2160/29.97p 1080/29.97p 1080/29.97PsF
	1080/59.94p	1080/59.94p
	1080/59.94i	1080/59.94i
	1080/29.97p	1080/29.97p
	1080/29.97PsF	1080/29.97PsF
	1080/23.98p(59.94i) *1	1080/23.98p(59.94i) *1
	720/59.94p	720/59.94p
50Hz	2160/50p	2160/50p 1080/50p *3
	2160/25p	2160/25p 1080/25p 1080/25PsF
	1080/50p	1080/50p
	1080/50i	1080/50i
	1080/25p	1080/25p
	1080/25PsF	1080/25PsF
	720/50p	720/50p
24Hz	2160/24p	2160/24p 1080/24p
	1080/24p	1080/24p
23.98Hz	2160/23.98p	2160/23.98p 1080/23.98p 1080/23.98PsF
	1080/23.98p	1080/23.98p
	1080/23.98PsF	1080/23.98PsF

*1 It denotes "1080/23.98p over 59.94i".

*2 When [UHD Crop] is [Crop(720)], output is 720/59.94p.

*3 When [UHD Crop] is [Crop(720)], output is 720/50p.

HDR Output Select [SDR, HDR(2020), HDR(709)]

Select the signal to be output when [Gamma Mode] is [HLG].

SDR	SDR output
HDR(2020)	HDR output (BT.2020 equivalent color gamut)
HDR(709)	HDR output (BT.709 equivalent color gamut)

<NOTE>

- [HDR Output Select] cannot be changed when [Gamma Mode] is other than [HLG] and [Color Setting] is other than [Normal]. (→ page 52, page 57)

V-Log Output Select [V-Log, V-709]

Select the signal to be output when [Color Setting] is [V-Log].

V-Log	Output with a gamma curve that has a wide range of tones and latitude (exposure range).
V-709	Converted for output to images suited to previewing.

<NOTE>

- [V-Log Output Select] cannot be changed when [Color Setting] is not [V-Log]. (→ page 57)

3G SDI Out [LevelA, LevelB]

When [Format] (12G SDI/OPTICAL) is [1080/59.94p] or [1080/50p], select the format for outputting 3G SDI signals.

LevelA	Level A format
LevelB	Level B format

<NOTE>

- [3G SDI Out] cannot be changed if [Format] (12G SDI/OPTICAL) is other than [1080/59.94p] or [1080/50p].

Return

Return to the previous menu level.

Output 2/9 screen

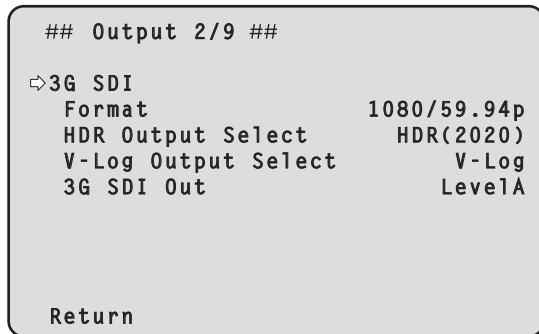

3G SDI

Make the settings for output from the 3G SDI OUT connector.

Format

Set the output format.

The following format settings are possible depending on the [Format] setting in the [System 1/2] screen.

Frequency	System Format	Format (3G SDI)
59.94Hz	2160/59.94p	1080/59.94p *2 1080/59.94i *2
	2160/29.97p	1080/29.97p 1080/29.97PsF
	1080/59.94p	1080/59.94p 1080/59.94i
	1080/59.94i	1080/59.94i
	1080/29.97p	1080/29.97p
	1080/29.97PsF	1080/29.97PsF
	1080/23.98p(59.94i) *1	1080/23.98p(59.94i) *1
	720/59.94p	720/59.94p
50Hz	2160/50p	1080/50p *3 1080/50i *3
	2160/25p	1080/25p 1080/25PsF
	1080/50p	1080/50p 1080/50i
	1080/50i	1080/50i
	1080/25p	1080/25p
	1080/25PsF	1080/25PsF
	720/50p	720/50p
	24Hz	2160/24p 1080/24p
23.98Hz	2160/23.98p	1080/23.98p 1080/23.98PsF
	1080/23.98p	1080/23.98p
	1080/23.98PsF	1080/23.98PsF

*1 It denotes "1080/23.98p over 59.94i".

*2 When [UHD Crop] is [Crop(720)], output is 720/59.94p.

*3 When [UHD Crop] is [Crop(720)], output is 720/50p.

HDR Output Select [SDR, HDR(2020), HDR(709)]

Select the signal to be output when [Gamma Mode] is [HLG].

SDR	SDR output
HDR(2020)	HDR output (BT.2020 equivalent color gamut)
HDR(709)	HDR output (BT.709 equivalent color gamut)

<NOTE>

- [HDR Output Select] cannot be changed when [Gamma Mode] is other than [HLG] and [Color Setting] is other than [Normal]. (→ page 52, page 57)

V-Log Output Select [V-Log, V-709]

Select the signal to be output when [Color Setting] is [V-Log].

V-Log	Output with a gamma curve that has a wide range of tones and latitude (exposure range).
V-709	Converted for output to images suited to previewing.

<NOTE>

- [V-Log Output Select] cannot be changed when [Color Setting] is not [V-Log]. (→ page 57)

3G SDI Out [LevelA, LevelB]

When [Format] (3G SDI) is [1080/59.94p] or [1080/50p], select the format for outputting 3G SDI signals.

LevelA	Level A format
LevelB	Level B format

<NOTE>

- [3G SDI Out] cannot be changed if [Format] (3G SDI) is other than [1080/59.94p] or [1080/50p].

Return

Return to the previous menu level.

Output 3/9 screen

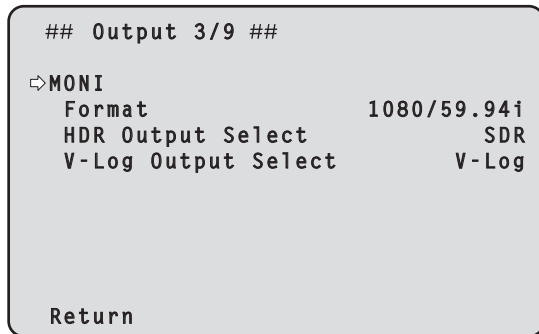

MONI

Make the settings for output from the MONITOR OUT connector <MONI OUT>.

Format

Set the output format.

The following format settings are possible depending on the [Format] setting in the [System 1/2] screen.

Frequency	System Format	Format (MONI)
59.94Hz	2160/59.94p	1080/59.94i *2
	2160/29.97p	1080/29.97p 1080/29.97PsF
	1080/59.94p	1080/59.94i
	1080/59.94i	1080/59.94i
	1080/29.97p	1080/29.97p
	1080/29.97PsF	1080/29.97PsF
	1080/23.98p(59.94i) *1	1080/23.98p(59.94i) *1
	720/59.94p	720/59.94p
50Hz	2160/50p	1080/50i *3
	2160/25p	1080/25p 1080/25PsF
	1080/50p	1080/50i
	1080/50i	1080/50i
	1080/25p	1080/25p
	1080/25PsF	1080/25PsF
	720/50p	720/50p
24Hz	2160/24p	1080/24p
	1080/24p	1080/24p
23.98Hz	2160/23.98p	1080/23.98p 1080/23.98PsF
	1080/23.98p	1080/23.98p
	1080/23.98PsF	1080/23.98PsF

*1 It denotes "1080/23.98p over 59.94i".

*2 When [UHD Crop] is [Crop(720)], output is 720/59.94p.

*3 When [UHD Crop] is [Crop(720)], output is 720/50p.

HDR Output Select [SDR, HDR(2020), HDR(709)]

Select the signal to be output when [Gamma Mode] is [HLG].

SDR	SDR output
HDR(2020)	HDR output (BT.2020 equivalent color gamut)
HDR(709)	HDR output (BT.709 equivalent color gamut)

<NOTE>

- [HDR Output Select] cannot be changed when [Gamma Mode] is other than [HLG] and [Color Setting] is other than [Normal]. (→ page 52, page 57)

V-Log Output Select [V-Log, V-709]

Select the signal to be output when [Color Setting] is [V-Log].

V-Log	Output with a gamma curve that has a wide range of tones and latitude (exposure range).
V-709	Converted for output to images suited to previewing.

<NOTE>

- [V-Log Output Select] cannot be changed when [Color Setting] is not [V-Log]. (→ page 57)

Return

Return to the previous menu level.

Output 4/9 screen

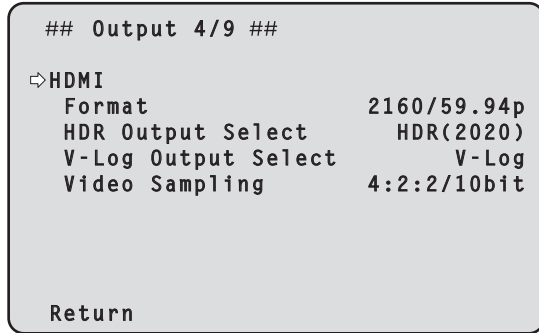

HDMI

Make the settings for output from the HDMI connector.

Format

Set the output format.

The following format settings are possible depending on the [Format] setting in the [System 1/2] screen.

Frequency	System Format	Format (HDMI)
59.94Hz	2160/59.94p	2160/59.94p 1080/59.94p *2
	2160/29.97p	2160/29.97p 1080/29.97p
	1080/59.94p	1080/59.94p
	1080/59.94i	1080/59.94i
	1080/29.97p	1080/29.97p
	1080/29.97PsF	1080/29.97p
	1080/23.98p(59.94i) *1	1080/23.98p(59.94p) *3
	720/59.94p	720/59.94p
50Hz	2160/50p	2160/50p 1080/50p *4
	2160/25p	2160/25p 1080/25p
	1080/50p	1080/50p
	1080/50i	1080/50i
	1080/25p	1080/25p
	1080/25PsF	1080/25p
	720/50p	720/50p
24Hz	2160/24p	2160/24p 1080/24p
	1080/24p	1080/24p
23.98Hz	2160/23.98p	2160/23.98p 1080/23.98p
	1080/23.98p	1080/23.98p
	1080/23.98PsF	1080/23.98p

*1 It denotes "1080/23.98p over 59.94i".

*2 When [UHD Crop] is [Crop(720)], output is 720/59.94p.

*3 It denotes "1080/23.98p over 59.94p".

*4 When [UHD Crop] is [Crop(720)], output is 720/50p.

HDR Output Select [SDR, HDR(2020), HDR(709)]

Select the signal to be output when [Gamma Mode] is [HLG].

SDR	SDR output
HDR(2020)	HDR output (BT.2020 equivalent color gamut)
HDR(709)	HDR output (BT.709 equivalent color gamut)

<NOTE>

- Other than when [Gamma Mode] is [HLG], [Color Setting] is [Normal], and [Video Sampling] is [4:2:2/10bit], [HDR Output Select] cannot be changed. (→ page 52, page 57)

V-Log Output Select [V-Log, V-709]

Select the signal to be output when [Color Setting] is [V-Log].

V-Log	Output with a gamma curve that has a wide range of tones and latitude (exposure range).
V-709	Converted for output to images suited to previewing.

<NOTE>

- [V-Log Output Select] cannot be changed when [Color Setting] is not [V-Log]. (→ page 57)

Video Sampling [4:2:2/10bit, 4:2:0/8bit]

When [Format] in [HDMI] is [2160/59.94p] or [2160/50p], select the video sampling output from the HDMI connector.

4:2:2/10bit	Output in 4:2:2/10bit mode.
4:2:0/8bit	Output in 4:2:0/8bit mode.

<NOTE>

- When [Format] in [HDMI] is other than [2160/59.94p] or [2160/50p], [Video Sampling] cannot be changed and is fixed at [4:2:2/10bit].

Return

Return to the previous menu level.

Camera menu items (continued)

Output 5/9 screen

## Output 5/9 ##	
↪ Bar	Camera
Color Bar Type	Type2
Tone	Normal
Audio	Off
Input Type	Line
Volume Level	0dB
Plugin Power	Off
Return	

Bar [Camera, Colorbar]

Switch between camera images and color bars.

Camera	Camera images
Colorbar	Color bar

Color Bar Type [Type1, Type2]

Select the type of color bar to display.

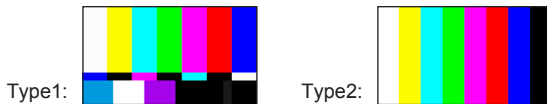

This is only enabled when [Bar] is set to [Colorbar].

<NOTE>

- Even if the [HDR Output Select] for each of the outputs is either [HDR(2020)] or [HDR(709)], the color bar for SDR is output.

Tone [Off, Low, Normal]

Make the settings for the test tone signal (1 kHz) output while the color bar is displayed.

Off	Test tone is not output.
Low	Test tone is output at low volume.
Normal	Test tone is output at normal volume.

This is only enabled when [Bar] is set to [Colorbar].

Audio [Off, On]

Turn audio input off/on.

Input Type [Mic, Line]

Mic	Set the microphone input.
Line	Set the line input.

This is only enabled when [Audio] is set to [On].

Volume Level [-36dB to +12dB]

Set the volume of audio output.

This is only enabled when [Audio] is set to [On].

Plugin Power [Off, On]

Turn the plugin power for the audio off/on.

This is only enabled when [Audio] is set to [On].

This is only enabled when [Input Type] is set to [Mic].

Return

Return to the previous menu level.

Output 6/9 screen

## Output 6/9 ##	
↪ OSD Mix	
12G SDI/OPTICAL	Off
3G SDI	Off
MONI	On
HDMI	Off
IP	On
Return	

OSD Mix

Select whether to turn off/on camera menu, status, and other displays for each output image.

12G SDI/OPTICAL [Off, On]

3G SDI [Off, On]

MONI [Off, On]

HDMI [Off, On]

IP [Off, On]

Off	The camera menus and statuses are not displayed on the output pictures covered by the setting items listed above.
On	The camera menus and statuses are displayed for the output pictures covered by the setting items listed above.

<NOTE>

- When this is set to [Off], the camera menu can be displayed for about 1 minute after the unit is turned on.

Return

Return to the previous menu level.

Output 7/9 screen

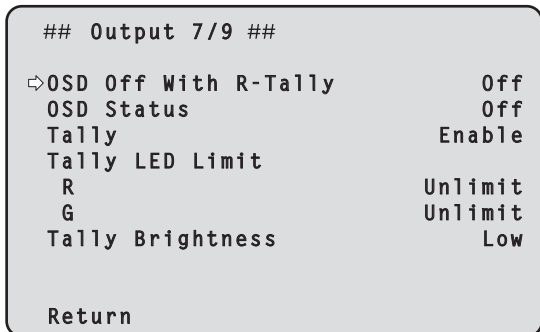

OSD Off With R-Tally [Off, On]

Off or on the function that turns off camera menu, status, and other displays when red tally signals are received via commands or contacts.

When the red tally signal releases, the camera menu display will return.

OSD Status [Off, On]

Turn the status display during AWB and ABB off/on, or error display when an error occurs.

Tally

[Enable, Disable]

[Disable] or [Enable] is set here for the function which turns on or turns off the tally lamp using the tally control signal.

Tally LED Limit

Sets whether to limit the lighting of the tally lamp for each of the tally control signal colors (R/G).

R [Limit, Unlimit]

G [Limit, Unlimit]

Limit	Limit the lighting of the tally lamp.
Unlimit	Light the tally lamp.

<NOTE>

- If [Limit] is selected for [Tally LED Limit], only the tally lamp of this unit is limited. The tally status display on external devices (the AW-RP150, AW-RP60 controller, etc.) remains enabled.

Tally Brightness [Low, Mid, High]

Adjust the brightness of the tally LED.

Return

Return to the previous menu level.

Output 8/9 screen

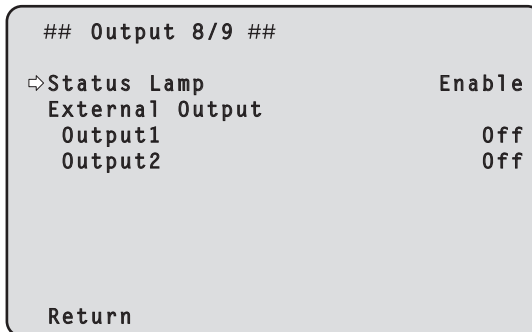

Status Lamp

[Enable, Disable]

[Disable] or [Enable] is set here for the status display lamp.

When you want the status display lamp to stay off while this unit is in operation, set to [Disable].

<NOTE>

- Even when set to [Disable], the status display lamp may light up when this unit is starting up, updating firmware, or trouble is occurring.

External Output

Select the signal type output from the External Output signal lines (Output1, Output2) of the RS-422 connector. (→ page 16)

Output1 [Off, R-Tally, G-Tally]

Output2 [Off, R-Tally, G-Tally]

Off	Signal is not output.
R-Tally	The reception status of the red tally signal is output.
G-Tally	The reception status of the green tally signal is output.

Return

Return to the previous menu level.

Output 9/9 screen

## Output 9/9 ##	
UHD Crop	Off
3G SDI Out	Crop
IP Out	Crop
Crop Out	YL
Crop Marker	YL+G+MG
Crop Adjust	YL
Crop H Position	960
Crop V Position	540
Return	

UHD Crop [Off, Crop(1080), Crop(720)]

Set the Crop function which crops UHD (3840×2160) images to 1920×1080 images or 1280×720 images.

Off	Disable the Crop function.
Crop(1080)	Crop UHD (3840×2160) images to 1920×1080 images. This is enabled only when [Format] in [System 1/2] screen is the following. 2160/59.94p, 2160/29.97p 2160/50p, 2160/25p 2160/24p, 2160/23.98p
Crop(720)	Crop UHD (3840×2160) images to 1280×720 images. This is enabled only when [Format] in [System 1/2] screen is the following. 2160/59.94p, 2160/50p

<NOTE>

- When [UHD Crop] is changed, IP video transmission is temporarily stopped.
- When [UHD Crop] is [Crop(1080)] or [Crop(720)], the following values cannot be set in [Streaming mode].
H.264(UHD), U.265(UHD), JPEG(UHD), SRT(H.264 UHD), SRT(H.265 UHD)
(→ page 105)
- When H.264(UHD), U.265(UHD), JPEG(UHD), SRT(H.264 UHD) or SRT(H.265 UHD) is selected in [Streaming mode] and [UHD Crop] is switched to [Crop(1080)] or [Crop(720)], the [Streaming mode] setting changes to [H.264].

3G SDI Out [Full, Crop]

IP Out [Full, Crop]

Make the settings for Full/Crop for images output to the 3G SDI OUT connector and IP.

Full	FHD down-converted images are output as is without cropping UHD images.
Crop	Images with FHD cropped from UHD images are output. The images output in this case are those with the crop frame specified in [Crop Out].

This is only enabled when [UHD Crop] is set to [Crop(1080)] or [Crop(720)].

Crop Out [YL, G, MG]

Make the settings for the crop frame for images output to the 3G SDI OUT connector and IP.

YL	Output the yellow crop frame images.
G	Output the green crop frame images.
MG	Output the magenta crop frame images.

This is only enabled when [UHD Crop] is set to [Crop(1080)] or [Crop(720)].

<NOTE>

- The color frame specified in [Crop Out] will be a deeper shade when compared to other colors used for frames.

Crop Marker [Off, YL, G, MG, YL+G, YL+MG, G+MG, YL+G+MG]

Make the settings for the crop frame displayed for images output to the MONITOR OUT connector <MONI OUT>.

Off	Crop frame is not displayed.
YL	Only a yellow crop frame is displayed.
G	Only a green crop frame is displayed.
MG	Only a magenta crop frame is displayed.
YL+G	Yellow and green crop frames are displayed.
YL+MG	Yellow and magenta crop frames are displayed.
G+MG	Green and magenta crop frames are displayed.
YL+G+MG	Yellow, green, and magenta crop frames are displayed.

This is only enabled when [UHD Crop] is set to [Crop(1080)] or [Crop(720)].

Crop Adjust [YL, G, MG]

Make selections for the crop frame to adjust positioning.

YL	Make position adjustments for the yellow crop frame.
G	Make position adjustments for the green crop frame.
MG	Make position adjustments for the magenta crop frame.

This is only enabled when [UHD Crop] is set to [Crop(1080)] or [Crop(720)].

<NOTE>

- The color frame specified in [Crop Adjust] will be thicker when compared to other color frames.

Crop H Position [0 to 2560]

Make settings for the position in the horizontal direction for the crop frame specified in [Crop Adjust].

The variable range is 0 to 1920 when [UHD Crop] is [Crop(1080)], with 0 as the left edge and 1920 as the right edge, and only even numbers can be set.

The variable range is 0 to 2560 when [UHD Crop] is [Crop(720)], with 0 as the left edge and 2560 as the right edge, and only even numbers can be set.

This is only enabled when [UHD Crop] is set to [Crop(1080)] or [Crop(720)].

Crop V Position [0 to 1440]

Make settings for the position in the vertical direction for the crop frame specified in [Crop Adjust].

The variable range is 0 to 1080 when [UHD Crop] is [Crop(1080)], with 0 as the upper edge and 1080 as the lower edge.

The variable range is 0 to 1440 when [UHD Crop] is [Crop(720)], with 0 as the upper edge and 1440 as the lower edge.

This is only enabled when [UHD Crop] is set to [Crop(1080)] or [Crop(720)].

Return

Return to the previous menu level.

■ The CROP function

When [UHD Crop] is set to [Crop(1080)] or [Crop(720)], it is possible to output images with FHD cropped from UHD signals from the 3G SDI OUT connector and IP. (Image 2)

Video signals of UHD videos down-converted to FHD are output to the MONITOR OUT connector <MONI OUT> at this time, and the crop frame according to the [Crop Marker] menu setting is displayed. (Image 1)

Furthermore, UHD images are output from the 12G SDI OUT connector, Optical connector, and HDMI connector, and the crop frame is not displayed.

Crop frame



Depending on the [3G SDI/IP Out] and [Crop Out] settings, images output from the 3G SDI OUT connector and IP will be as shown below.

3G SDI/IP Out	Crop Out	Images output from 3G SDI OUT connector and IP
Full	–	UHD images down-converted to FHD
Crop	YL	Yellow frame FHD crop images
	G	Green frame FHD crop images
	MG	Magenta frame FHD crop images

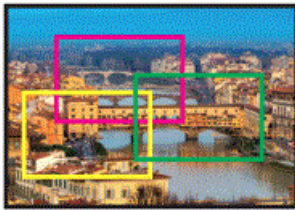

Depending on the [Crop Marker] setting, it is possible to select the crop frame output to the MONITOR OUT connector <MONI OUT>.

Crop Marker	Crop frame display
Off	Crop frame is not displayed.
YL	Only a yellow crop frame is displayed.
G	Only a green crop frame is displayed.
MG	Only a magenta crop frame is displayed.
YL+G	Yellow and green crop frames are displayed.
YL+MG	Yellow and magenta crop frames are displayed.
G+MG	Green and magenta crop frames are displayed.
YL+G+MG	Yellow, green, and magenta crop frames are displayed.

Pan/Tilt screen

```

## Pan/Tilt ##
◁ Install Position          Desktop
Smart Picture Flip         Off
Flip Detect Angle         90deg
P/T Speed Mode            Normal(60deg/s)
Speed With Zoom Position   On
Focus Adjust With PTZ.    Off
Power On Position         None
Preset Number             001

Return
    
```

Install Position

[Desktop, Hanging]

[Desktop] or [Hanging] is selected here as the method used to install the unit.

Desktop	Stand-alone installation
Hanging	Suspended installation

<NOTE>

- When [Hanging] has been selected, the top, bottom, left and right of the images will be reversed, and up/down/left/right control for panning and tilting will also be reversed.

Smart Picture Flip [Off, Auto]

When the tilt becomes the angle set for [Flip Detect Angle], the image will be flipped in the vertical direction automatically.

Off	The picture is not turned upside down.
Auto	The picture is automatically turned upside down.

Flip Detect Angle [60deg to 120deg]

Set the tilt angle at which the image will be flipped in the vertical direction automatically when [Smart Picture Flip] is set to [Auto].

P/T Speed Mode [Normal(60deg/s), Fast(180deg/s), Quick(60deg/s)]

Set the speed of pan/tilt operation.

Normal (60deg/s)	Pan/tilt operates at normal speed (maximum about 60° per second).
Fast (180deg/s)	Pan/tilt operates at fast speed (maximum about 180° per second).
Quick (60deg/s)	Pan/tilt operates at normal speed (maximum about 60° per second) and acceleration and deceleration (rise time and fall time) are faster.

<NOTE>

- The pan/tilt operation noise may increase when [Fast(180deg/s)] is selected.
- Even when [Fast(180deg/s)] is selected, the pan/tilt speed during preset playback will be the same speed as when [Normal(60deg/s)] is selected.

Speed With Zoom Position [Off, On]

[Off] or [On] is set here for the function used to adjust the pan-tilt adjustment speed in conjunction with the zoom magnification.

When [On] is set, the panning and tilting operations will become slower in the zoom status.

This function has no effect during preset operations.

Focus Adjust With PTZ. [Off, On]

[Off] or [On] is set here for the function which compensates for out-of-focusing when it occurs during panning, tilting or zooming operations. When [Off] is set, adjust the focus as required after zooming or set [Focus Mode] to [Auto].

This is only enabled when [Manual] has been selected as the [Focus Mode] setting.

Power On Position [None, Standby, Home, Preset]

Select the initial positions for Pan/Tilt/Zoom when the power is turned on.

None	Keep the positions of Pan/Tilt when the power was last on, with Zoom being at the Wide end.
Standby	Move to the Pan/Tilt/Zoom positions they were in the last time the camera was switched to Standby mode.
Home	Pan/Tilt move to their home positions (front) and Zoom goes to the Wide end.
Preset	Preset playback is performed at the preset position specified with [Preset Number].

Preset Number [001 to 100]

Specify a number for preset playback when the power turns ON when [Preset] is set in [Power On Position].

<NOTE>

- If an unregistered preset number is set, preset playback is not performed and the operation is the same as [None].

Return

Return to the previous menu level.

Preset 1/2 screen

## Preset 1/2 ##	
⊣ Preset Speed Unit	Speed Table
Preset Speed Table	Fast
Preset Speed	20
Preset Acceleration	Auto
Acceleration	3
Preset Scope	Mode A
Preset Digital Extender	Off
Preset Crop	Off
Return	

Preset Speed Unit [Speed Table, Time]

When reproducing the information such as camera direction registered in the preset memory, you can select whether to specify the playback time by speed or by time.

Speed Table	Specify the speed when playing during preset playback.
Time	Specify the time when playing during preset playback.

Preset Speed Table [Slow, Fast]

Set the preset speed table (Slow, Fast). During preset playback, presets are performed at [Preset Speed] (1 to 30) values that are based on the table set here.

This is only enabled when [Preset Speed Unit] is set to [Speed Table].

Preset Speed [1 to 30/1s to 99s]

When [Preset Speed Unit] is [Speed Table]: [1 to 30]

Set the pan/tilt operation speed in 30 steps when playing back the preset memory.

<NOTE>

- When you set large [Preset Speed] values, the image may sway when the movement stops.

When [Preset Speed Unit] is [Time]: [1s to 99s]

Set the pan/tilt operation time between 1 and 99 seconds when playing back the preset memory.

<NOTE>

- Depending on the movement distance of pan/tilt, there may be a difference compared to the specified time.

Preset Acceleration [Manual, Auto]

Sets whether to set the acceleration and deceleration when starting or stopping preset playback.

Manual	Make settings for acceleration when starting or stopping preset playback.
Auto	Acceleration is automatic when starting or stopping preset playback.

<NOTE>

- This is enabled only when [Preset Speed Unit] is [Speed Table].

Acceleration [1 to 6]

Sets the acceleration speed for pan/tilt acceleration operation in 6 steps. (The acceleration speed increases as the number increases)

<NOTE>

- This is enabled only when [Preset Speed Unit] is [Speed Table] and [Preset Acceleration] is [Manual].

Preset Scope [Mode A, Mode B, Mode C]

Selected here are the setting items to be recalled when the contents of the preset memory are regenerated.

Mode A	Pan, Tilt, Zoom (including digital zoom), Focus, Iris, Gain, white balance adjustment value
Mode B	Pan, Tilt, Zoom (including digital zoom), Focus, Iris
Mode C	Pan, Tilt, Zoom (including digital zoom), Focus

Preset Digital Extender [Off, On]

Turns the preset digital extender function off/on.

When set to [On], the digital extender function configuration will be recalled when regenerating the preset memory.

When set to [Off], the digital extender function configuration will not be recalled when storing the preset memory.

Preset Crop [Off, On]

When the preset memory is played back, set whether the reproduction of content set in the various [UHD Crop] menus is off/on. When set to [On], the content set in the various [UHD Crop] menus is reproduced when preset memory is played back.

When set to [Off], the content set in the various [UHD Crop] menus is not reproduced when preset memory is played back, with the current values being kept.

<NOTE>

- This is enabled only when [Format] in [System 1/2] screen is the following.
2160/59.94p, 2160/29.97p
2160/50p, 2160/25p
2160/24p, 2160/23.98p
- This is only enabled when [UHD Crop] is set to [Crop(1080)] or [Crop(720)].
- When [UHD Crop] is [Off] or [Crop(1080)] and preset memory is registered and preset playback is executed when [UHD Crop] is [Crop(720)], then, even if [Preset Crop] is [On], the content set in each menu of [UHD Crop] is not recalled.
- When [UHD Crop] is [Crop(720)] and preset memory is registered and preset playback is executed when [UHD Crop] is [Crop(1080)], then, even if [Preset Crop] is [On], the content set in each menu of [UHD Crop] is not recalled.

Return

Return to the previous menu level.

Preset 2/2 screen

```

## Preset 2/2 ##
⇨ Preset Thumbnail Update      On
Preset Name                    Reset
Preset Iris                     Off
Preset Zoom Mode                Mode A
Freeze During Preset           Off

Return
    
```

Preset Thumbnail Update [Off, On]

Turn off/on the function for registering the still image (thumbnail) for the images being output when a preset memory is registered. When set to [On], the still image (thumbnail) for the images being output is registered when registering a preset memory. When set to [Off], the still image (thumbnail) for the images being output is not registered when registering a preset memory, but rather the still image (thumbnail) previously registered is maintained.

<NOTE>

- When the IP for [OSD Mix] is [On], the menu screen is included in the thumbnails.
- When [UHD Crop] is [Crop(1080)] or [Crop(720)], the cropped still image is registered rather than the Full image.
- When uploading Camera(ALL) or Camera(SYSTEM) on the web screen or other access, the still image (thumbnail) that has been registered in preset memory will be erased. (→ page 151)

Preset Name [Reset, Hold]

When registering a preset memory, set whether to reset the previously registered preset name or keep it.

Reset	When registering a preset memory, reset the previously registered preset name. The preset name after resetting will be [Preset***]. (*** is a 3 digit preset number: 001 to 100)
Hold	When registering a preset memory, keep the previously registered preset name.

<NOTE>

- The factory default setting for the preset name is [Preset***]. (***) is a 3 digit preset number: 001 to 100)
- The registration of preset names can be done in the web browser. 0 to 9, A to Z, a to z, _ , and space

Preset Iris [Off, On]

When the preset memory is played back, set whether the reproduction of the values in the various menus related to Iris is off/on.

When set to [On], the values set in the various menus below are reproduced when preset memory is played back.

- Picture Level
- Iris Mode
- Auto Iris Speed
- Auto Iris Window
- Auto Iris Close Limit

<NOTE>

- Its setting takes effect when [Mode A] or [Mode B] has been selected as the [Preset Scope] setting.

Preset Zoom Mode [Mode A, Mode B]

Select the zoom operation for when preset memory is recalled.

Mode A	Perform the zoom operation in line with the pan/tilt operation.
Mode B	Perform the zoom operation quicker than the pan/tilt operation.

Freeze During Preset [Off, On]

Turn the function for freezing images during preset playback off/on.

When this is set to [On], preset playback is performed with a still of the image immediately preceding the start of preset playback being output. The image freeze is released when preset playback is finished.

Return

Return to the previous menu level.

Maintenance screen

```
## Maintenance ##  
⇨ Firmware Version  
IP Network  
Initialize  
Hour Meter  
HDMI Status  
Error Status  
  
Return
```

Firmware Version

This is selected to display the [Firmware Version] screen on which the user can check the version of the firmware which is currently installed in the unit.

IP Network

This is selected to display the [IP Network] screen on which the user can check and make settings for the [IP Address], [Subnet Mask] and [Default Gateway] settings which have been set in the unit.

Initialize

This is selected to display the [Initialize] screen on which the user can initialize the camera settings.
For details on operation, refer to “Concerning initialization” (→ page 76).

Hour Meter

This is selected to display the [Hour Meter] screen on which the operation history is displayed.

HDMI Status

Display the [HDMI Status] screen that displays the status of HDMI output.

Error Status

Display the [Error Status] screen that displays the status of errors.

Return

Return to the previous menu level.

Firmware Version 1/2 screen

```
### Firmware Version 1/2 ###  
System Version          V01.00  
  
CPU Software  
Main/Network           V01.00  
Camera                 V01.00  
Lens                  V01.00  
Servo                 V01.00  
Interface              V01.00  
  
⇨ Return
```

System Version

Display the version for overall system of the unit.

CPU Software

Main/Network

Display the main/network software version.

Camera

Display the software version of the camera.

Lens

Display the software version of the lens.

Servo

Display the software version of the servo.

Interface

Display the software version of the interface.

Return

Return to the previous menu level.

Firmware Version 2/2 screen

```

### Firmware Version 2/2 ###
EEPROM
Main/Network          V01.00
Interface             V01.00

FPGA
COM                  V01.00
AVIO                 V01.00

⇨ Return
    
```

EEPROM

Main/Network

Display the EEPROM version of the main/network.

Interface

Display the EEPROM version of the interface.

FPGA

COM

Display the FPGA version for communications.

AVIO

Display the FPGA version for image processing.

Return

Return to the previous menu level.

IP Network screen

```

### IP Network ###
IP Address              192.168.0.10
Subnet Mask            255.255.255.0
Default Gateway        192.168.0.1

Set Execute

⇨ Return
    
```

IP Address

Set the IP address for this unit.

The set value is applied to this unit when [Set Execute] is executed.

Subnet Mask

Set the subnet mask for this unit.

The set value is applied to this unit when [Set Execute] is executed.

Default Gateway

Set the default gateway for this unit.

The set value is applied to this unit when [Set Execute] is executed.

Set Execute

Apply the values set in [IP Address], [Subnet Mask], and [Default Gateway] to this unit.

Return

Return to the previous menu level.

<NOTE>

- The IP Network cannot be changed while the DHCP function is On.
- If the DHCP function is not to be used, change the setting for [DHCP] to [Off] in the network settings screen of your web browser. (→ page 132)

Camera menu items (continued)

■ Concerning initialization

When [Initialize] is selected on the [Maintenance] screen, the [Initialize] screen appears.

Initialize screen

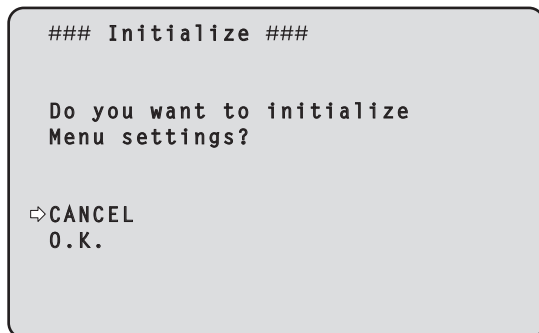

- When the cursor is moved to [O.K.] on the [Initialize] screen and the setting is entered, the [Menu settings initialized] screen is displayed for 5 seconds, and the camera settings are restored to the settings which were established when the camera was purchased.

<NOTE>

- The [Format] and [Frequency] settings (→ page 57) are not initialized.
- The network settings are not initialized.
- The [AWB] and [ABB] adjustment values are not initialized.

Menu settings initialized screen

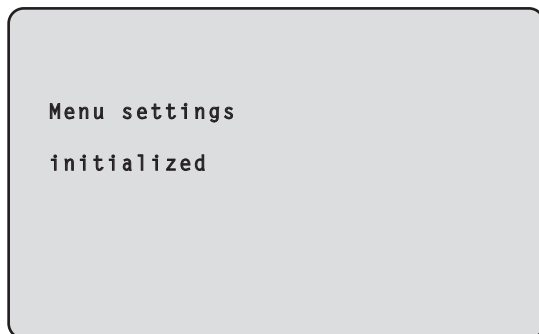

- When the cursor is moved to [CANCEL] on the [Initialize] screen and the setting is entered, the [Menu settings unchanged] screen is displayed for 5 seconds, the initialization operation is not performed, and the [Maintenance] screen returns to the display.

Menu settings unchanged screen

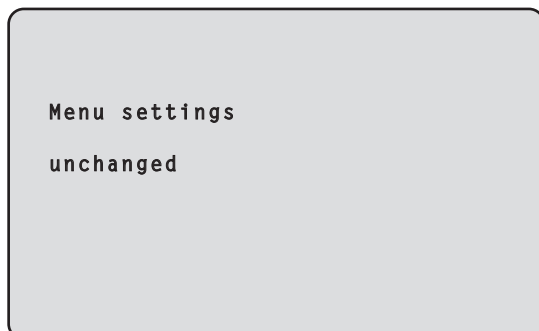

Hour Meter screen

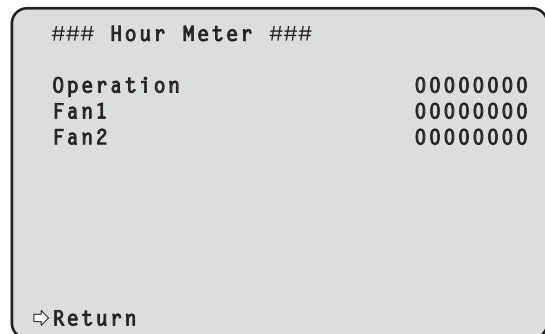

Operation

Displays the cumulative time that power has been supplied to the unit. (8-digit numerical value)

Fan1

Display the cumulative hours of operation of the cooling fan near the lens. (8-digit numerical value)

Fan2

Display the cumulative hours of operation of the cooling fan near the pan-tilt head. (8-digit numerical value)

Return

Return to the previous menu level.

Camera menu items (continued)

HDMI Status screen

### HDMI Status ###	
Connect	HDMI
Format	2160/59.94p
Video Sampling	YPbPr 4:2:2/10bit
HDR Output	HLG(2020)
Monitor	Available
⏪ Return	

Connect

Displays the connection status of the HDMI connector.
One of the following is displayed according to the product specifications of the device or monitor connected.

Unconnect	Not connected.
HDMI	Connected via HDMI.
DVI	Connected via DVI.

Format

Displays the format of the images being output via the HDMI connector.
The same format is displayed as is specified in [Format] in [HDMI] in the [Output 4/9] screen.

Video Sampling

The video sampling of the images being output via the HDMI connector is displayed.
One of the following is displayed according to the menu settings and the product specifications of the device or monitor connected.

---	Displayed when [Connect] is other than HDMI.
RGB 8bit	Displayed when [Connect] is HDMI and output is RGB 8bit.
YPbPr 4:2:2/10bit	Displayed when [Connect] is HDMI and output is YPbPr 4:2:2/10bit.
YPbPr 4:2:0/8bit	Displayed when [Connect] is HDMI and output is YPbPr 4:2:0/8bit.

<NOTE>

- Even if the video sampling is set in [Video Sampling] in [HDMI] in the [Output 4/9] screen, it may not be possible to output using the specified format due to the product specifications of the HDMI connected device or monitor.
This item displays the status of the video sampling actually being output.

HDR Output

The HDR signal status of the images being output via the HDMI connector is displayed.
One of the following is displayed according to the product specifications of the device or monitor connected.

---	Displayed when [Connect] is other than HDMI.
SDR(709)	Displayed when [Connect] is HDMI and output is SDR(709).
HLG(2020)	Displayed when [Connect] is HDMI and output is HLG(2020).
HLG(709)	Displayed when [Connect] is HDMI and output is HLG(709).

Monitor

Displays the status of the device or monitor connected to the HDMI connector.
One of the following is displayed according to the product specifications of the device or monitor connected.

---	Displayed when [Connect] is other than HDMI.
Available	This indicates that [Connect] is HDMI and the device or monitor connected supports the format output by this unit.
Unsupport UHD	This indicates that [Connect] is HDMI and the device or monitor connected does not support the format output by this unit.
Unsupport UHD 60p/50p	
Unsupport UHD 60p 4:2:2	
Unsupport UHD 50p 4:2:2	
Unsupport UHD 60p 4:2:0	
Unsupport UHD 50p 4:2:0	
Unsupport HLG/2020	
Unsupport HLG	
Unsupport 2020	
Unsupport Format	

Return

Return to the previous menu level.

Error Status screen

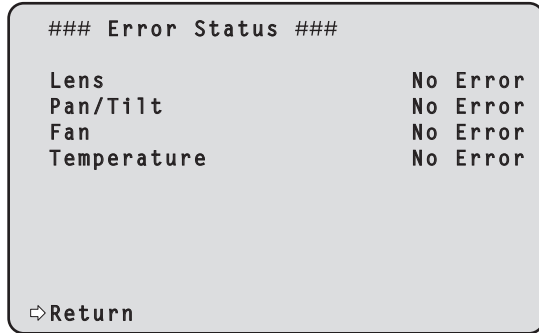

Lens [No Error, Error]

This displays the error status of the lens.

No Error	The lens is operating normally.
Error	A lens error has occurred.

Pan/Tilt [No Error, Error]

This displays the error status of the pan-tilt drive section.

No Error	The pan-tilt drive section is operating normally.
Error	A pan-tilt drive section error has occurred.

Fan [No Error, Error]

This displays the error status of the fan.

No Error	The fan is operating normally.
Error	A fan error has occurred.

Temperature [No Error, High Temperature, Sensor Error]

This displays the status of temperature related errors.

No Error	Within normal operating temperature range.
High Temperature	Temperature is high.
Sensor Error	The temperature sensor may have malfunctioned.

<NOTE>

- When the above errors occur, notification of the errors are sent via IP/serial to the external device (AW-RP150, etc.), so these errors can be displayed on the external device.

Return

Return to the previous menu level.

Camera menu item table

Camera menu			Item	Factory setting	Selection items			
Top Menu	Camera	Scene	Scene	Scene1	Scene1, Scene2, Scene3, Scene4			
			Brightness 1/2	Brightness	Picture Level	0	-50 to +50 (step: 1)	
				Brightness 1/2	Iris Mode	Auto	Manual, Auto	
					Auto Iris Speed	Normal	Slow, Normal, Fast	
					Auto Iris Window	Normal1	Normal1, Normal2, Center	
					Auto Iris Close Limit	Normal	Normal, F8, F7, F5.6	
					Shutter Mode	Off	Off, Step, Synchro, ELC	
					Step/Synchro (When [Shutter Mode] is set to [Step])	[59.94Hz] 1/100 [50Hz] 1/120	<ul style="list-style-type: none"> • 59.94p/59.94i mode 1/60, 1/100, 1/120, 1/250, 1/500, 1/1000, 1/2000, 1/4000, 1/8000, 1/10000 • 29.97p mode 1/30, 1/60, 1/100, 1/120, 1/250, 1/500, 1/1000, 1/2000, 1/4000, 1/8000, 1/10000 • 23.98p/24p mode 1/24, 1/48, 1/60, 1/100, 1/120, 1/250, 1/500, 1/1000, 1/2000, 1/4000, 1/8000, 1/10000 • 50p/50i mode 1/60, 1/100, 1/120, 1/250, 1/500, 1/1000, 1/2000, 1/4000, 1/8000, 1/10000 • 25p mode 1/25, 1/50, 1/60, 1/100, 1/120, 1/250, 1/500, 1/1000, 1/2000, 1/4000, 1/8000, 1/10000 	
				Step/Synchro (When [Shutter Mode] is set to [Synchro])	[59.94Hz] 60.0Hz [50Hz] 50.0Hz	<ul style="list-style-type: none"> • 59.94p/59.94i mode 60.0 Hz to 7200 Hz • 29.97p mode 30.0 Hz to 7200 Hz • 23.98p/24p mode 24.0 Hz to 7200 Hz • 50p/50i mode 50.0 Hz to 7200 Hz • 25p mode 25.0 Hz to 7200 Hz 		
				ELC Limit (When [Shutter Mode] is set to [ELC])	1/250	1/100, 1/120, 1/250		
				Brightness 2/2	Gain	0dB	(When [Super Gain] is set to [On]) Auto, -3dB to 42dB (step: 1dB) (When [Super Gain] is set to [Off]) Auto, -3dB to 36dB (step: 1dB)	
			Super Gain		Off	Off, On		
			AGC Max Gain		18dB	6dB, 12dB, 18dB		
			Frame Mix		Off	Off, 6dB, 12dB, 18dB, 24dB		
			ND Filter		Through	Through, 1/4, 1/16, 1/64		
			Day/Night		Day	Day, Night		
			Picture 1/8	Picture 1/8	White Balance Mode	AWB A	AWB A, AWB B, ATW, 3200K, 5600K, VAR	
					Color Temperature	3200K	2000K to 15000K	
					R Gain	0	-200 to +200	
					B Gain	0	-200 to +200	
					Color TEMP. Setting			
					White Balance Mode			
					Color Temperature	3200K	2000K to 15000K	
					R Gain	0	-400 to +400	
					B Gain	0	-400 to +400	
					G Axis	0	-400 to +400	
					AWB Gain Offset	Off	Off, On	
					ATW Speed	Normal	Normal, Slow, Fast	
					ATW Target R	0	-10 to +10	
			ATW Target B	0	-10 to +10			

Camera menu item table (continued)

Camera menu				Item	Factory setting	Selection items					
Top Menu	Camera	Scene	Picture	Picture 2/8	Chroma Level	0%	Off, -99% to 99% (step: 1%)				
					Chroma Phase	0	-31 to +31				
					Master Pedestal	0	-200 to +200 (step: 1)				
					R Pedestal	0	-100 to +100 (step: 1)				
					G Pedestal	0	-100 to +100 (step: 1)				
					B Pedestal	0	-100 to +100 (step: 1)				
					Pedestal Offset	Off	Off, On				
				Picture 3/8	Detail	On	Off, On				
					Master Detail	0	-31 to +31				
					Detail Coring	15	0 to 60				
					V Detail Level	0	-7 to +7				
					Detail Frequency	0	-7 to +7				
					Level Depend.	0	-7 to +7				
					Knee Aperture Level	2	0 to 5				
					Detail Gain(+)	0	-31 to +31				
					Detail Gain(-)	0	-31 to +31				
				Picture 4/8	Skin Detail	Off	Off, On				
					Skin Detail Effect	16	0 to 31				
				Picture 5/8	DownCon Detail	On	Off, On				
					DC. Master Detail	-20	-31 to +31				
					DC. Detail Coring	15	0 to 60				
					DC. V Detail Level	7	-7 to +7				
					DC. Detail Frequency	0	-2 to +2				
					DC. Level Depend.	0	-7 to +7				
				Picture 6/8	Gamma Mode	HD	HD, FILMLIKE1, FILMLIKE2, FILMLIKE3, FILM REC, VIDEO REC, HLG				
					Gamma	0.45	0.30 to 0.75 (Step: 0.01)				
					F-REC Dynamic Level	500%	200%, 300%, 400%, 500%, 600%				
					F-REC Black STR. Level	0%	0% to 30% (Step: 1%)				
					V-REC Knee Slope	150%	150%, 200%, 250%, 300%, 350%, 400%, 450%, 500%				
					V-REC Knee Point	30%	30% to 107% (Step: 1%)				
					Black Gamma	0	-8 to +8				
					Black Gamma Range	1	1 to 3				
					DRS	Off	Off, Low, Mid, High				
				Picture 7/8	Knee Mode	Auto	Off, Auto, Manual				
					Auto Knee Response	4	1 to 8				
					Knee Point	93.0%	70.0% to 107.0% (Step: 0.5%)				
					Knee Slope	99	0 to 99				
					HLG Knee	Off	Off, On				
					HLG Knee Point	55%	55% to 100% (Step: 1%)				
				Picture 8/8	White Clip	On	Off, On				
					White Clip Level	109%	90% to 109% (Step: 1%)				
					DNR	Low	Off, Low, High				
				Matrix	Matrix 1/5	Matrix Type	Normal	Normal, EBU, NTSC, User			
						Adaptive Matrix	Off	Off, On			
					Matrix 2/5	[Linear Matrix]	Normal	EBU	NTSC	User	
						R-G	0	3	-21	0	-63 to +63
						R-B	0	3	-18	0	-63 to +63
						G-R	16	4	21	0	-63 to +63
						G-B	19	12	20	0	-63 to +63
						B-R	0	-16	-15	0	-63 to +63
						B-G	18	16	14	0	-63 to +63

Camera menu item table (continued)

Camera menu				Item	Factory setting				Selection items		
Top Menu	Camera	Scene	Matrix	Matrix 3/5	[Color Correction 1/3]	Normal	EBU	NTSC	User		
					B_Mg Saturation	15	0	0	0	-63 to +63	
					B_Mg Phase	6	0	0	0	-63 to +63	
					Mg Saturation	13	0	0	0	-63 to +63	
					Mg Phase	10	0	0	0	-63 to +63	
					Mg_R Saturation	4	3	0	0	-63 to +63	
					Mg_R Phase	10	0	-9	0	-63 to +63	
					Mg_R_R Saturation	2	-3	-5	0	-63 to +63	
					Mg_R_R Phase	6	-7	-19	0	-63 to +63	
					R Saturation	0	-7	8	0	-63 to +63	
					R Phase	1	-4	-9	0	-63 to +63	
					R_R_YI Saturation	4	7	13	0	-63 to +63	
					R_R_YI Phase	6	1	0	0	-63 to +63	
					Matrix 4/5	[Color Correction 2/3]	Normal	EBU	NTSC	User	
						R_YI Saturation	5	5	20	0	-63 to +63
				R_YI Phase		11	2	6	0	-63 to +63	
				R_YI_YI Saturation		10	12	22	0	-63 to +63	
				R_YI_YI Phase		3	0	6	0	-63 to +63	
				YI Saturation		8	12	24	0	-63 to +63	
				YI Phase		0	0	6	0	-63 to +63	
				YI_YI_G Saturation		3	9	8	0	-63 to +63	
				YI_YI_G Phase		2	0	4	0	-63 to +63	
				YI_G Saturation		18	16	15	0	-63 to +63	
				YI_G Phase		8	6	7	0	-63 to +63	
				G Saturation		20	13	11	0	-63 to +63	
				G Phase		16	0	6	0	-63 to +63	
				Matrix 5/5		[Color Correction 3/3]	Normal	EBU	NTSC	User	
						G_Cy Saturation	15	14	16	0	-63 to +63
					G_Cy Phase	8	6	8	0	-63 to +63	
					Cy Saturation	9	7	0	0	-63 to +63	
					Cy Phase	8	14	17	0	-63 to +63	
					Cy_B Saturation	1	0	0	0	-63 to +63	
					Cy_B Phase	11	0	18	0	-63 to +63	
					B Saturation	5	0	0	0	-63 to +63	
				B Phase	-10	0	5	0	-63 to +63		
	Lens	Focus Mode	Auto			Manual, Auto					
		Zoom Mode	Opt.Zoom			Opt.Zoom, i.Zoom, D.Zoom					
		Max Digital Zoom	x10			x2 to x10 (Step: 1)					
		Digital Extender	Off			Off, x1.4, x2.0					
		OIS	Off			Off, On					
	System	System 1/2	Frequency	AW-UE150WP/AW-UE150KP: 59.94Hz AW-UE150WE/AW-UE150KE: 50Hz			59.94Hz, 50Hz, 24Hz, 23.98Hz				
			Format	AW-UE150WP/AW-UE150KP: 2160/59.94p AW-UE150WE/AW-UE150KE: 2160/50p			(When [Frequency] is set to [59.94Hz]) 2160/59.94p, 2160/29.97p, 1080/59.94p, 1080/59.94i, 1080/29.97p, 1080/29.97PsF, 1080/23.98p(59.94i)*1, 720/59.94p (When [Frequency] is set to [50Hz]) 2160/50p, 2160/25p, 1080/50p, 1080/50i, 1080/25p, 1080/25PsF, 720/50p (When [Frequency] is set to [24Hz]) 2160/24p, 1080/24p (When [Frequency] is set to [23.98Hz]) 2160/23.98p, 1080/23.98p, 1080/23.98PsF				
			Shooting Mode	Normal			Normal, High Sens.				
			Color Setting	Normal			Normal, V-Log				
			Genlock								
			Horizontal Phase	0			-206 to +49				
			System 2/2	Tracking Data Output							
				Serial	Off			Off, On			
				IP	Off			Off, On			
				Invert Pan/Tilt Axis	Off			Off, On			
				Camera ID	0xFF			0x00 to 0xFF			
			Wireless Control	Enable			Enable, Disable				
			Fan1	High			Auto, Low, Mid, High				
			Fan2	High			Auto, Low, Mid, High				

*1 It denotes "1080/23.98p over 59.94i".

Camera menu item table (continued)

Camera menu		Item	Factory setting	Selection items			
Top Menu	Output	Output 1/9	12G SDI/OPTICAL				
			Format	AW-UE150WP/AW-UE150KP: 2160/59.94p AW-UE150WE/AW-UE150KE: 2160/50p	[System Format] 2160/59.94p 2160/29.97p 1080/59.94p 1080/59.94i 1080/29.97p 1080/29.97PsF 1080/23.98p(59.94i)*1 720/59.94p 2160/50p 2160/25p 1080/50p 1080/50i 1080/25p 1080/25PsF 720/50p 2160/24p 1080/24p 2160/23.98p 1080/23.98p 1080/23.98PsF	[12G SDI/OPTICAL] 2160/59.94p 1080/59.94p*2 2160/29.97p 1080/29.97p 1080/29.97PsF 1080/59.94i 1080/29.97p 1080/29.97PsF 1080/23.98p(59.94i)*1 720/59.94p 2160/50p 1080/50p*3 2160/25p 1080/25p 1080/25PsF 1080/50p 1080/50i 1080/25p 1080/25PsF 720/50p 2160/24p 1080/24p 1080/24p 2160/23.98p 1080/23.98p 1080/23.98PsF 1080/23.98p 1080/23.98PsF	
			HDR Output Select	HDR(2020)	SDR, HDR(2020), HDR(709)		
			V-Log Output Select	V-Log	V-Log, V-709		
			3G SDI Out	LevelA	LevelA, LevelB		
			Output 2/9	3G SDI			
				Format	AW-UE150WP/AW-UE150KP: 1080/59.94p AW-UE150WE/AW-UE150KE: 1080/50p	[System Format] 2160/59.94p 2160/29.97p 1080/59.94p 1080/59.94i 1080/29.97p 1080/29.97PsF 1080/23.98p(59.94i)*1 720/59.94p 2160/50p 2160/25p 1080/50p 1080/50i 1080/25p 1080/25PsF 720/50p 2160/24p 1080/24p 2160/23.98p 1080/23.98p 1080/23.98PsF	[3G SDI] 1080/59.94p*2 1080/59.94i*2 1080/29.97p 1080/29.97PsF 1080/59.94p 1080/59.94i 1080/29.97p 1080/29.97PsF 1080/23.98p(59.94i)*1 720/59.94p 1080/50p*3 1080/50i*3 1080/25p 1080/25PsF 1080/50p 1080/50i 1080/25p 1080/25PsF 720/50p 1080/24p 1080/24p 1080/23.98p 1080/23.98PsF 1080/23.98p 1080/23.98PsF
				HDR Output Select	HDR(2020)	SDR, HDR(2020), HDR(709)	
				V-Log Output Select	V-Log	V-Log, V-709	
			3G SDI Out	LevelA	LevelA, LevelB		

*1 It denotes "1080/23.98p over 59.94i".

*2 When [UHD Crop] is [Crop(720)], output is 720/59.94p.

*3 When [UHD Crop] is [Crop(720)], output is 720/50p.

Camera menu item table (continued)

Camera menu		Item	Factory setting	Selection items	
Top Menu	Output	Output 3/9	MONI		
		Format	AW-UE150WP/AW-UE150KP: 1080/59.94i AW-UE150WE/AW-UE150KE: 1080/50i	[System Format] 2160/59.94p 2160/29.97p 1080/59.94p 1080/59.94i 1080/29.97p 1080/29.97PsF 1080/23.98p(59.94i)*1 720/59.94p 2160/50p 2160/25p 1080/50p 1080/50i 1080/25p 1080/25PsF 720/50p 2160/24p 1080/24p 2160/23.98p 1080/23.98p 1080/23.98PsF	[MONI] 1080/59.94i*2 1080/29.97p 1080/29.97PsF 1080/59.94i 1080/59.94i 1080/29.97p 1080/29.97PsF 1080/23.98p(59.94i)*1 720/59.94p 1080/50i*3 1080/25p 1080/25PsF 1080/50i 1080/50i 1080/25p 1080/25PsF 720/50p 1080/24p 1080/24p 1080/23.98p 1080/23.98PsF 1080/23.98p 1080/23.98PsF
		HDR Output Select	SDR	SDR, HDR(2020), HDR(709)	
		V-Log Output Select	V-Log	V-Log, V-709	
		Output 4/9	HDMI		
		Format	AW-UE150WP/AW-UE150KP: 2160/59.94p AW-UE150WE/AW-UE150KE: 2160/50p	[System Format] 2160/59.94p 2160/29.97p 1080/59.94p 1080/59.94i 1080/29.97p 1080/29.97PsF 1080/23.98p(59.94i)*1 720/59.94p 2160/50p 2160/25p 1080/50p 1080/50i 1080/25p 1080/25PsF 720/50p 2160/24p 1080/24p 2160/23.98p 1080/23.98p 1080/23.98PsF	[HDMI] 2160/59.94p 1080/59.94p*2 2160/29.97p 1080/29.97p 1080/59.94p 1080/59.94i 1080/29.97p 1080/29.97p 1080/29.97PsF 1080/23.98p(59.94p)*4 720/59.94p 2160/50p 1080/50p*3 2160/25p 1080/25p 1080/50p 1080/50i 1080/25p 1080/25p 1080/25p 720/50p 2160/24p 1080/24p 1080/24p 2160/23.98p 1080/23.98p 1080/23.98p 1080/23.98p 1080/23.98p
		HDR Output Select	HDR(2020)	SDR, HDR(2020), HDR(709)	
		V-Log Output Select	V-Log	V-Log, V-709	
		Video Sampling	4:2:2/10bit	4:2:2/10bit, 4:2:0/8bit	
	Output 5/9	Bar	Camera	Camera, Colorbar	
	Color Bar Type	Type2	Type1, Type2		
	Tone	Normal	Off, Low, Normal		
	Audio	Off	Off, On		
	Input Type	Line	Mic, Line		
	Volume Level	0dB	-36dB to +12dB (Step: 3dB)		
	Plugin Power	Off	Off, On		

*1 It denotes "1080/23.98p over 59.94i".

*2 When [UHD Crop] is [Crop(720)], output is 720/59.94p.

*3 When [UHD Crop] is [Crop(720)], output is 720/50p.

*4 It denotes "1080/23.98p over 59.94p".

Camera menu item table (continued)

Camera menu		Item	Factory setting	Selection items	
Top Menu	Output	Output 6/9	OSD Mix		
			12G SDI/OPTICAL	Off	Off, On
			3G SDI	Off	Off, On
			MONI	On	Off, On
			HDMI	Off	Off, On
		IP	On	Off, On	
		Output 7/9	OSD Off With R-Tally	Off	Off, On
			OSD Status	Off	Off, On
			Tally	Enable	Enable, Disable
			Tally LED Limit		
			R	Unlimit	Limit, Unlimit
			G	Unlimit	Limit, Unlimit
		Tally Brightness	Low	Low, Mid, High	
		Output 8/9	Status Lamp	Enable	Enable, Disable
			External Output		
			Output1	Off	Off, R-Tally, G-Tally
		Output 9/9	Output2	Off	Off, R-Tally, G-Tally
			UHD Crop	Off	Off, Crop(1080), Crop(720)
			3G SDI Out	Crop	Full, Crop
			IP Out	Crop	Full, Crop
			Crop Out	YL	YL, G, MG
			Crop Marker	YL+G+MG	Off, YL, G, MG, YL+G, YL+MG, G+MG, YL+G+MG
			Crop Adjust	YL	YL, G, MG
		Crop H Position	960	0 to 2560 (Step: 2)	
		Crop V Position	540	0 to 1440	
		Pan/Tilt	Install Position	Desktop	Desktop, Hanging
			Smart Picture Flip	Off	Off, Auto
	Flip Detect Angle		90deg	60deg to 120deg (Step: 1deg)	
	P/T Speed Mode		Normal(60deg/s)	Normal(60deg/s), Fast(180deg/s), Quick(60deg/s)	
	Speed With Zoom Position		On	Off, On	
	Focus Adjust With PTZ.		Off	Off, On	
	Power On Position		None	None, Standby, Home, Preset	
	Preset Number		001	001 to 100	
	Preset		Preset 1/2	Preset Speed Unit	Speed Table
		Preset Speed Table		Fast	Slow, Fast
		Preset Speed (When [Preset Speed Unit] is set to [Speed Table])		20	1 to 30
		Preset Speed (When [Preset Speed Unit] is set to [Time])		20s	1s to 99s
Preset Acceleration		Auto		Manual, Auto	
Acceleration		3		1 to 6	
Preset Scope		Mode A		Mode A, Mode B, Mode C	
Preset Digital Extender		Off		Off, On	
Preset Crop		Off		Off, On	
Preset 2/2		Preset Thumbnail Update	On	Off, On	
		Preset Name	Reset	Reset, Hold	
		Preset Iris	Off	Off, On	
		Preset Zoom Mode	Mode A	Mode A, Mode B	
		Freeze During Preset	Off	Off, On	

Camera menu item table (continued)

Camera menu				Item	Factory setting	Selection items			
Top Menu	Maintenance	Firmware Version	Firmware Version 1/2	System Version	Version at shipping	---			
				CPU Software					
				Main/Network	Version at shipping	---			
				Camera	Version at shipping	---			
				Lens	Version at shipping	---			
				Servo	Version at shipping	---			
			Interface	Version at shipping	---				
			Firmware Version 2/2	EEPROM					
				Main/Network	Version at shipping	---			
				Interface	Version at shipping	---			
				FPGA					
				COM	Version at shipping	---			
		AVIO		Version at shipping	---				
		IP Network			IP Address	192.168.0.10	---		
					Subnet Mask	255.255.255.0	---		
					Default Gateway	192.168.0.1	---		
		Initialize			---	CANCEL	CANCEL, OK		
		Hour Meter			Operation	00000000	---		
					Fan1	00000000	---		
					Fan2	00000000	---		
		HDMI Status			Connect	---	---		
					Format	---	---		
					Video Sampling	---	---		
					HDR Output	---	---		
					Monitor	---	---		
		Error Status			Lens	No Error	No Error, Error		
					Pan/Tilt	No Error	No Error, Error		
					Fan	No Error	No Error, Error		
					Temperature	No Error	No Error, High Temperature, Sensor Error		

Displaying the web screen

With a personal computer connected to the unit, it is possible to view the camera's IP videos or select various settings from the web browser.

The LAN crossover cable is used when connecting a personal computer directly to the unit's LAN connector for IP control, and the LAN straight cable is used when making the connection through a switching hub.

Select an IP address for the personal computer within the private address range while ensuring that it is different from the address of the unit. Set the subnet mask to the same address as the unit.

<NOTE>

- If you need to change the IP address and subnet mask, be sure to ask your dealer to make these changes for you.

Unit's IP address and subnet mask (factory settings)*1

IP address: 192.168.0.10
 Subnet mask: 255.255.255.0

*1 The factory default for the private address range is between 192.168.0.1 and 192.168.0.255.

- If the controller and web browser are being used at the same time, the content selected using the controller may not be reflected on the web browser display. When using both the controller and web browser, be absolutely sure to check the settings using the controller or camera menu.

For details of the required personal computer environment, refer to page 8.

<NOTE>

- Some functions on the web setting screen can be used only from Windows Internet Explorer 11. Functions which can be used by Windows Internet Explorer 11 only are indicated using the **Windows I.E.11** mark.
- The "Network Camera View 4S" plug-in viewer software must have already been installed in order to display the unit's IP videos using Windows Internet Explorer 11. This is not necessary when using web browsers other than Windows Internet Explorer 11. For details, refer to "Installing the plug-in viewer software" (→ page 29).
- When [IP(UDP)] of [Tracking Data Output] is set to [On] and opening the web screen, a warning message will be displayed. Click the [Continue] button to leave the web screen open.
- While the web screen is displayed, the tracking data that is output when [IP(UDP)] of [Tracking Data Output] is [On] may be delayed or the data value may not be updated. (→ page 128)

Displaying the web screen using a personal computer

The procedure is explained here using Windows screens (Internet Explorer). When using other browsers, some screen displays will be different, but the procedure is similar.

1. Start the web browser of the personal computer.

Use one of the web browsers below depending on the operating system installed in the personal computer.

Operating system installed	Web browser
Windows	Windows 7 64/32-bit/Internet Explorer 11 Windows 10/Internet Explorer 11 Windows 10/Microsoft Edge Windows 10/Google Chrome
macOS	OS X 10.11/Safari 11 macOS 10.12/Safari 11 macOS 10.13/Safari 11 macOS 10.13/Google Chrome

2. Enter the IP address you configured on the Easy IP Setup Software in the address bar of the web browser.

IPv4 address entry example:

http://URL registered with IPv4 address
 http://192.168.0.10/

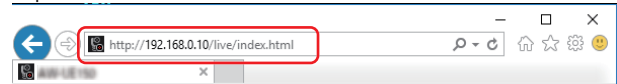

IPv6 address entry example:

http://[URL registered with IPv6 address]
 http://[2001:db8::10]/

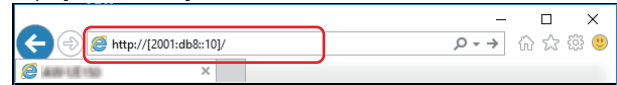

<NOTE>

- If the HTTP port number has been changed from "80", enter "http://<camera IP address>:<port number>" in the address bar. Example: When the port number is set to 8080: http://192.168.0.11:8080
- If the unit is located on the local network, configure proxy server settings on the web browser ([Tools] - [Internet Options] in the menu bar) so that a proxy server is not used for the local address.
- For details on when [HTTPS] - [Connection] (→ page 137) is set to [HTTPS] in the [Advanced] of the network setup screen [Network], see "Accessing the Camera by HTTPS" (→ page 145).

Displaying the web screen (continued)

3. Set the initial account.

In the initial state, the initial account setting screen is displayed when the web screen is displayed.

Set a user name and password.

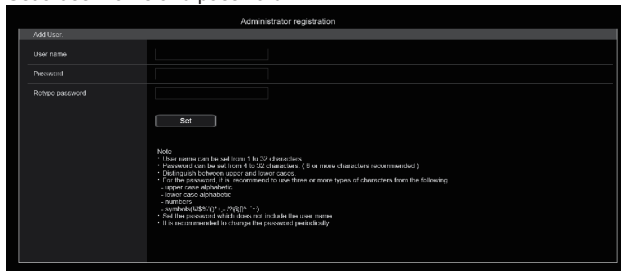

<NOTE>

- Do not set character strings that can be easily guessed by third parties.
- Change the password at regular intervals.
- The password must use at least 3 of the following 4 character types and be 8 characters or longer.
 - Alphabet upper cases
 - Alphabet lower cases
 - Numerals
 - Symbols (! # \$ % ' () * + , - . / ? @ [] ^ _ ` ~)
- When a password is set that does not adhere to the above policy, take responsibility for use of the device with due consideration for the security risks in the installation environment, etc.
- A warning is displayed if the set password goes against the recommended setting policy. When changing the password, click the [Back] button and set the password again. When continuing with the setting with full understanding of the security risks, click [Continue] to complete the setting.
- If you forget the account information that was set, use the switches for initialization of service switches to reset the user information used for connecting to the network. (→ page 16)

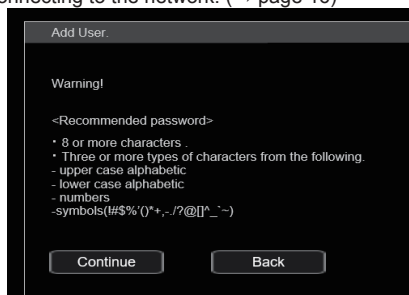

4. Completing registration of the initial account

After completing registration of the initial account, the following registration completed screen is displayed.

The live screen [Live] is automatically displayed after about 10 seconds elapse after the completed screen is displayed.

If the live screen [Live] is not displayed after 10 seconds elapse, manually move to the live screen [Live] by clicking the “please click here” link.

This completes the process of registering the initial account.

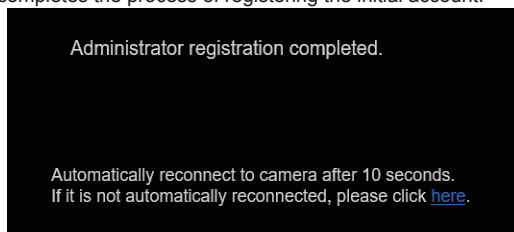

<NOTE>

- Network connection with AW-RP150 requires setup of an initial account. (→ page 29)
When an initial account is not set up, AW-RP150 can detect but cannot control this unit.

5. Display the live screen [Live].

The web screen appears.



The live screen [Live] (→ page 89) is displayed initially. You can switch to the web setup screen [Setup] (→ page 94) when necessary. (→ page 88)





<NOTE>

- Standby mode is the factory default setting, so switch to Power ON mode.
- If the personal computer does not have the plug-in viewer software already installed, an installation confirmation message is displayed before the live screen [Live] is displayed. In a case like this, follow the on-screen instructions to install the software. [Windows I.E.11](#)
For details, refer to “Installing the plug-in viewer software” (→ page 29).
- Depending on the firewall settings on your personal computer, transmitted images may not be displayed. If this occurs, change the firewall settings and change the settings to permit communications with your web browser.
- When an attempt is made to display multiple IP images on one personal computer, IP videos may not be displayed depending on the performance of the personal computer concerned.
- A maximum of 14 users, including users receiving IP video, can access the unit simultaneously. However, the number of users that can access the unit may be restricted to less than 14 depending on the network communication bandwidth used by the unit. A message indicating the access limit will appear if the number of users exceeds 14. When [Transmission type] is set to [Multicast port] for [H.264] or [H.265], the second and subsequent users receiving H.264 or H.265 images will not be counted toward the total access count.
- When [H.264 transmission] (→ page 107) is set to [On], H.264 images are displayed. When it is set to [Off], JPEG images will be displayed. JPEG images can be displayed even when [H.264 transmission] is set to [On]. [Windows I.E.11](#)
- The JPEG image frame rate may be slower depending on the network environment, performance of your personal computer, subject of the video, and access volume.

Switching between the Live screen [Live] and Web setup screen [Setup]

When the live screen [Live]  is displayed, click the [Setup] button  at the top of the live screen [Live].

For details on the web setup screen [Setup], see “Web setup screen [Setup]” (→ page 94).

When the web setup screen [Setup]  is displayed, click the [Live] button  at the top of the web setup screen [Setup].

For details on the live screen [Live], see “Live screen [Live]” (→ page 89).

<NOTE>

- During Standby mode, the [Setup] button is disabled, and you cannot switch to the web setup screen [Setup].
- If the unit is switched to Standby mode from another terminal while the web setup screen [Setup] is displayed, the display will switch to the live screen [Live] after a few seconds.

Logging into the Web screen

When user authentication is enabled

When displaying the live screen [Live]

You need to enter account information for a user with Camera control or Administrator privileges.

When displaying the web setup screen [Setup]

You need to enter account information for a user with Administrator privileges.

When user authentication is disabled

When displaying the live screen [Live]

It is not necessary to enter account information.

When displaying the web setup screen [Setup]

You need to enter account information for a user with Administrator privileges.

<NOTE>

- The account input screen is displayed in a pop up screen from your web browser.
- Correctly enter the user name and password that has already been registered.
- It is recommended that the password be changed at regular intervals.
- During Standby mode, the [Setup] button is disabled, and you cannot switch to the web setup screen [Setup].

Web screen operations

Live screen [Live]

You can display images from the camera on a personal computer and perform camera operations, such as pan, tilt, zoom, and focus control. The items displayed on the screen will differ depending on whether the [H.264] or [JPEG] button is selected under [Compression].

When [H.264] is selected Windows I.E.11



Operation screen display buttons (for touch panels)

Displays screen with larger operation buttons for touch panels. For details, refer to "Displaying the web screen using a personal computer equipped with a touch panel" (→ page 152).



Expansion panel display button
(→ page 92, page 93)

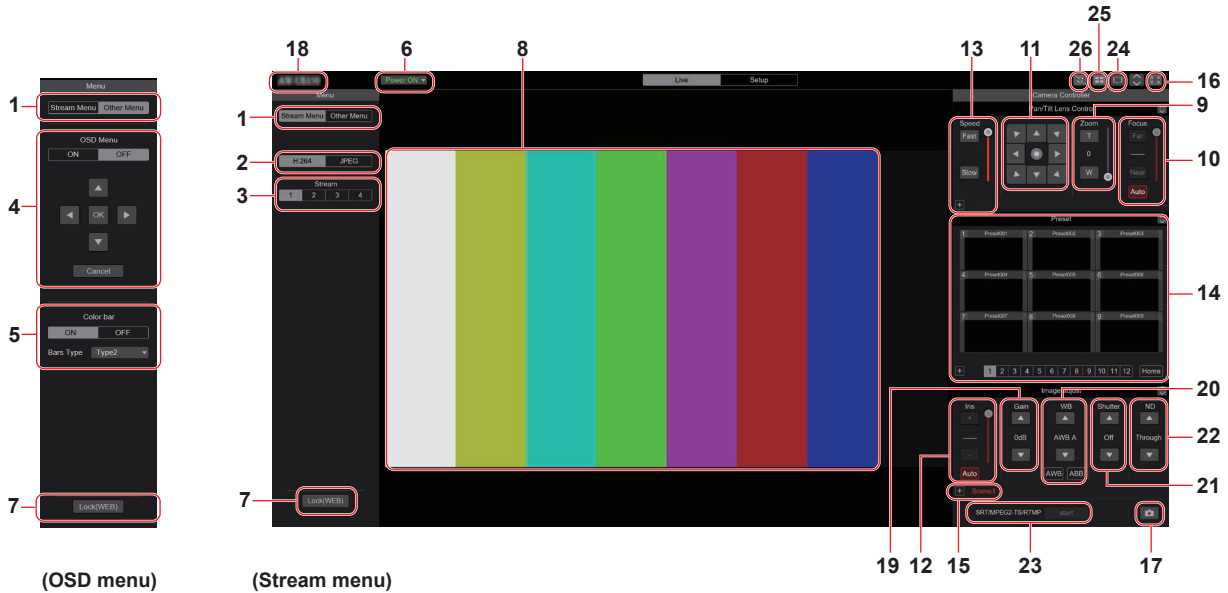

When [JPEG] is selected



Operation screen display buttons (for touch panels)

Displays screen with larger operation buttons for touch panels. For details, refer to "Displaying the web screen using a personal computer equipped with a touch panel" (→ page 152).



Expansion panel display button
(→ page 92, page 93)

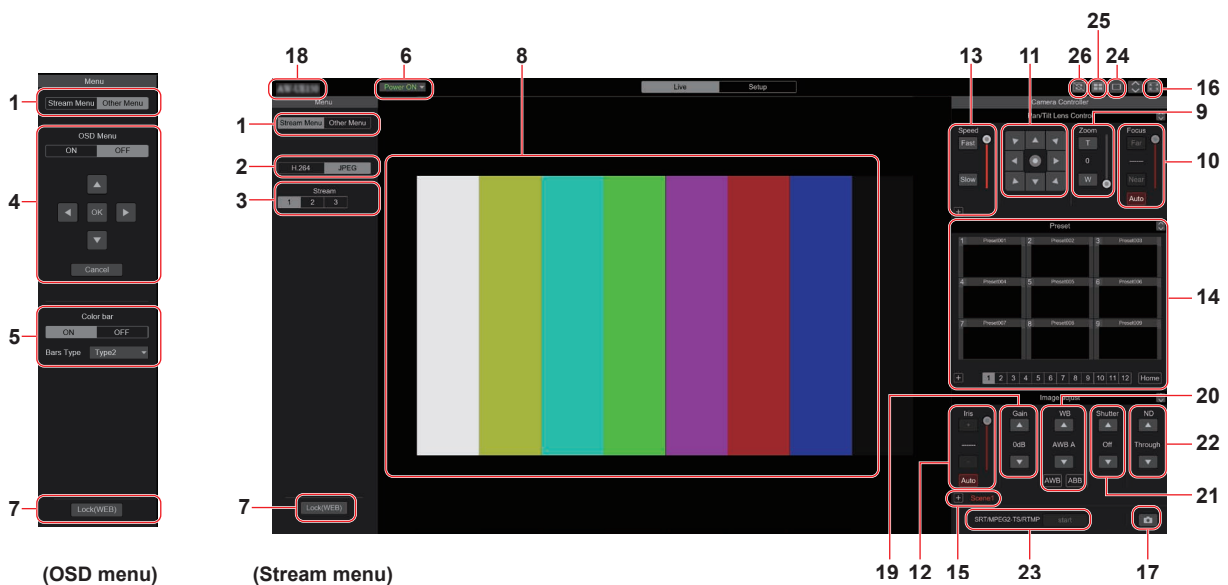



1. Menu switching [Stream Menu]/[Other Menu]

Switch between menu displays.

Clicking [Other Menu] when the Stream menu is displayed displays the Other menu.

Clicking [Stream Menu] when the Other menu is displayed displays the Stream menu.

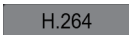
2. Compression button [Compression]

 H.264 [H.264]	The [H.264] button turns gray, and H.264 images are displayed. Windows I.E. 11 The [H.264] button is enabled when the [H.264 transmission] setting of [H.264(1)] to [H.264(4)] on the Video over IP is [On]. (→ page 107)
 JPEG [JPEG]	The [JPEG] button turns gray, and JPEG images are displayed.

<NOTE>





- In the following cases, the selection status of the [Compression] buttons will return to the setting configured in the [Video over IP] - [Initial display setting] - [Stream] (→ page 105).
 - When returning from another screen
 - When the screen is updated

3. Stream buttons [Stream]

When H.264 is selected

These buttons appear only when H.264 images are displayed.

[Windows I.E. 11](#)



 1 [1]	When selected, the button turns gray, and the images in the main area appear according to the settings configured for [H.264(1)]. (→ page 107)
 2 [2]	When selected, the button turns gray, and the images in the main area appear according to the settings configured for [H.264(2)]. (→ page 107)
 3 [3]	When selected, the button turns gray, and the images in the main area appear according to the settings configured for [H.264(3)]. (→ page 107)
 4 [4]	When selected, the button turns gray, and the images in the main area appear according to the settings configured for [H.264(4)]. (→ page 107)

<NOTE>

- In the following cases, the selection status of the [Stream] buttons will return to the setting configured in the [Video over IP] - [Initial display setting] - [Stream] (→ page 105).
 - When returning from another screen
 - When the screen is updated
- If the H.264 image resolution is set to [1920x1080] or [1280x720], the image may be compressed depending on the size of the web browser window.

When JPEG is selected



These buttons appear only when JPEG images are displayed.

 1 [1]	When selected, the button turns gray, and the images in the main area appear according to the settings configured for [JPEG(1)]. (→ page 106)
 2 [2]	When selected, the button turns gray, and the images in the main area appear according to the settings configured for [JPEG(2)]. (→ page 106)
 3 [3]	When selected, the button turns gray, and the images in the main area appear according to the settings configured for [JPEG(3)]. (→ page 106)



<NOTE>

- The resolution selected with [JPEG(1)], [JPEG(2)], and [JPEG(3)] (→ page 106) under [JPEG] in the [Video over IP] will be used.
- If the resolution is set to [1920x1080] or [1280x720], the image may be compressed depending on the size of the web browser window.
- In the following cases, the selection status of the [Image Capture Size] buttons will return to the setting configured in the [Video over IP] - [Initial display setting] - [Stream] (→ page 105).
 - When returning from another screen
 - When the screen is updated

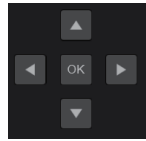

4. OSD Menu Operation [OSD Menu]

 [ON] [OFF]	Use this to select whether the camera's on-screen displays are to be shown.
 [Cancel]	It cancels the selection of the setting which is being changed. It restores the pre-change setting.
 [▲] [▼] [◀] [▶] [OK]	Use these to perform the menu operations. The items are selected using the [▲][▼][◀][▶] buttons. If a selected item has a sub menu, this sub menu is displayed by pressing the [OK] button. When the cursor is moved to any item on the bottom-level setting screen and the [OK] button is pressed, the setting of the selected item starts flashing. A setting for a regular menu item is reflected immediately if it is changed while it is still flashing. However, there are a number of menu items whose setting is reflected only after the [OK] button has been pressed, causing the setting to stop flashing and the new setting to be entered.

5. Color bar button [Color bar]

 [ON] [OFF]	Switch the color bar signal displayed or hide.
 [Type1] [Type2]	Switch the color bar displayed between Type1 and Type2. This is only enabled when [Color bar] is set to [ON].

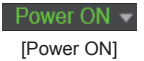
6. Power ON button [Power ON]/Standby button [Standby]

 [Power ON]	Turn the unit on.
 [Standby]	Set the unit to Standby mode.

In the Standby mode, all the buttons on the live screen [Live] except for the [Power ON] button and [Standby] button are disabled.

<NOTE>

- If [Power ON] or [Standby] is selected too quickly, the status selected and the display shown may not correspond. In a case like this, follow the steps below to restore the correct status display:

For Windows:

Press the [F5] key on the keyboard of the personal computer.

For Mac:

Press the [Command] + [R] keys on the keyboard of the personal computer.



• **When operation is transferred to the Standby mode:**

The current Pan/Tilt/Zoom positions are stored. When [Standby] is selected in the [Power ON Position] menu, the information about the stored positions is used.

• **When operation is transferred to the Power ON mode:**

Pan/Tilt/Zoom are moved to the positions selected in the [Power ON Position] menu.

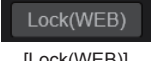
7. Operation lock button [Lock]

 [Lock(WEB)]	<p>This prevents erroneous operation by locking operations such as pan/tilt, zoom, focus, iris, gain, white balance, shutter, ND filter, and preset in the live screen [Live].</p> <p>The button turns red while locked, and the lock is released when the button is clicked again.</p>
 [Lock(CAM)]	<p>This is displayed when the unit is locked with the camera lock function on a Panasonic controller (AW-RP150), and you can unlock the camera by clicking this.</p>

<NOTE>

- When locked using a [Lock(WEB)] function, the status is maintained by the web browser, so the lock is released by redisplaying the web browser.
- The lock status using the [Lock(CAM)] function is maintained by the camera itself, so you need to either release the camera lock function using a Panasonic controller (AW-RP150) or release [Lock(CAM)] from the web browser while the camera is locked.
- It is not possible to enable the [Lock(CAM)] function from the web browser.

8. Main area (IP video display area)



The IP video of the connected camera will be displayed.

When the tally lamp of the camera is on, a red and a green lines are displayed at the top of the videos. A red line is displayed when receiving the red tally signal and a green line is displayed when receiving the green tally signal.

When the tally lamp is off, the display area will return to normal.



When you click inside the area, the camera moves so the clicked position becomes the center of the area.

Operating the mouse wheel inside the display area allows you to use the plug-in viewer software's digital zoom. [Windows I.E.11](#)

<NOTE>

- When the shooting scenes vary significantly, restrictions imposed by the graphics processing (GDI) of the operating system installed may give rise to a phenomenon called "screen tearing" (where parts of the picture are not displayed in synchronization) although this will depend on the personal computer used.
- On Windows Internet Explorer 11, if [H.264 transmission] (→ page 107) is set to [On], H.264 images can be displayed.
- On browsers other than Windows Internet Explorer 11, regardless of the [H.264 transmission] settings, only JPEG images can be displayed. (H.264 images will not appear.)
- The speed at which the JPEG images are refreshed may be reduced depending on the network environment, performance of the personal computer used, subjects and number of access users.
- A total of 14 users, including users receiving IP video, can access the unit simultaneously. However, when the IP video transmission bandwidth reaches its upper limit, access may be restricted to less than 14 users.
- When [Disable] is selected for [Tally] (→ page 68, page 102), the camera's tally lamp will not light even when the tally signal is input. However, a red and a green lines are displayed at the top of the main area (IP video display area).
- The camera may not move so the clicked position becomes the center of the area when you click inside the area within a tilt range of ±15° of the vertical of the unit.
- When [IP(UDP)] of [Tracking Data Output] is set to [On], video transmission via IP may be delayed or the video may suffer frame loss. (→ page 128)
We recommend setting [IP(UDP)] of [Tracking Data Output] to [Off] to avoid the delay or frame loss due to the video transmission via IP.

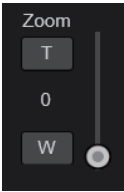

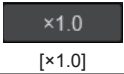
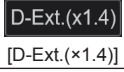
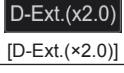
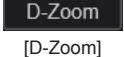
9. Zoom [Zoom]

	[T]: Use this to adjust the zoom (magnification) in the "Tele" direction. [W]: Use this to adjust the zoom (magnification) in the "Wide" direction. The optical zoom position is displayed in the center as a value. Value range: 000 (Wide end) to 999 (optical Tele end)
	Display button for PTZ expansion panel The [D-Zoom], [D-Ext.(×1.4)], [D-Ext.(×2.0)], and [×1.0] buttons for zoom and [O.T.AF] and [Touch AF] buttons for focus (→ page 92) are displayed. The display changes to [-] while these are displayed, and they stop being displayed when this is pressed again.
	Use this to adjust the zoom (magnification) to 1.0x.
	Use this to enable or disable digital extender x1.4.
	Use this to enable or disable digital extender x2.0.
	Use this to enable or disable the digital zoom.

<NOTE>

- The values indicating the optical zoom position do not change while zoom is still being operated within the digital zoom region.
- When digital zoom is enabled, it is possible to zoom in with the digital zoom by clicking the [T] button, even if the optical zoom position is optical Tele end 999.
- The [D-Zoom], [D-Ext.(×1.4)], [D-Ext.(×2.0)] and [×1.0] buttons are not displayed immediately after the live screen [Live] is displayed. They are displayed when the [Display button for PTZ expansion panel] is pressed.

10.Focus [Focus]

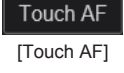
	[Far]: Use this to adjust the focus in the "Far" direction. It does not work during automatic adjustments. [Near]: Use this to adjust the focus in the "Near" direction. It does not work during automatic adjustments. The focal distance is displayed in the center as a value. Value range: 00 (Near) to 99 (Far)
	Use this to switch between auto and manual focusing. When Auto is selected, the focus is adjusted automatically.
	When this is pressed while the focus is being adjusted manually, the focus will be adjusted automatically once only. It does not work during automatic adjustments. It is displayed when the [Display button for PTZ expansion panel] (→ page 92) is pressed.
	When this is pressed while the focus is being adjusted manually, the focus will be adjusted automatically in the area touched. It does not work during automatic adjustments. It is displayed when the [Display button for PTZ expansion panel] (→ page 92) is pressed.



<NOTE>

- The [O.T.AF] and [Touch AF] buttons are not displayed immediately after the live screen [Live] is displayed. They are displayed when the [Display button for PTZ expansion panel] is pressed.

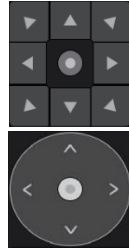
11.Control pad and its buttons

	To adjust the image in the horizontal or vertical direction (panning or tilting), left-click the pad and the buttons. It is possible to operate with the central grid pattern in the dragged state, with the speed of the pan/tilt increasing as it approaches the outside of the pad.
--	---







12.Brightness [Iris]

	[+]: Operates in stages in the direction of iris opening. It does not work during automatic adjustments. [-]: Operates in stages in the direction of iris closing. It does not work during automatic adjustments. The F value is displayed in the center.
	Use this to switch the iris adjustment between auto and manual. When Auto is selected, the picture brightness is adjusted automatically.

13.Speed [Speed]

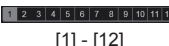
	Use this to select the speed at which the pan, tilt, zoom, and focus operations are to be performed. The speed of pan/tilt operation is reflected in control pad operations. It is not reflected in grip button operations.
--	--

14.Preset [Preset]

	When a preset thumbnail is clicked, the camera moves to face towards a preset position that was registered beforehand. You can select Home and Preset1 to Preset100. Preset numbers are displayed in green when they have had a preset position registered in them.
	Preset names are displayed. During the preset registration mode, you can select a preset name and change the display name. You can enter between 1 to 15 characters. The characters available are 0 to 9, A to Z, a to z, spaces, and underscores (_).
	Switches the page of the displayed preset thumbnails.
	Move to home position.
	Display button for preset expansion panel The [SET] and [DEL] buttons for presetting are displayed. The display changes to [-] while these are displayed, and they stop being displayed when this is pressed again.
	The unit moves to the preset registration mode. When a preset thumbnail is clicked in the preset registration mode, it is registered in the preset position specified by the current condition.
	The unit moves to the preset delete mode. When a preset thumbnail is clicked in the preset delete mode, the specified preset position settings are deleted.

<NOTE>

- If the [Preset Thumbnail Update] menu is [Off] when registering presets, the previously registered preset thumbnail is maintained.
- If the [Preset Name] menu is [Reset] when registering presets, the previously registered preset name is reset.
- The [SET] and [DEL] buttons are not displayed immediately after the live screen [Live] is displayed. They are displayed when the [Display button for preset expansion panel] is pressed.

15.Scene [Scene]

	Click Scene1-Scene4 to switch the shooting mode.
	Display button for scene expansion panel The [Scene1], [Scene2], [Scene3], and [Scene4] buttons for scene files are displayed. The display changes to [-] while these are displayed, and they stop being displayed when this is pressed again.

<NOTE>

- The [Scene1], [Scene2], [Scene3] and [Scene4] buttons are not displayed immediately after the live screen [Live] is displayed. They are displayed when the [Display button for scene expansion panel] is pressed.

16.Full-screen display button

	Display the image in full-screen mode. To return to the live screen [Live], press the [Esc] key on the personal computer while the image is displayed in full-screen mode. The aspect ratio of the displayed image will be adjusted according to the monitor size.
--	--

17.Snapshot button

	Capture a snapshot (single still image), and display it in a separate window.
--	---

<NOTE>

- The following settings may be necessary. In the Internet Explorer menu bar, click [Tools] - [Internet Options] - [Security] tab, select [Trusted Sites], and then click [Sites]. Register the camera's address under [Websites] in the window that appears.
- Depending on the network environment, for example, if snapshot capture takes longer than a certain amount of time, the image may not appear.
- If [JPEG transmission(1)] - [JPEG transmission(3)] (→ page 106) are all set to [Off], the image captured with the snapshot button will be black.

18.Camera title display area

The name for the unit configured in [Camera title] in [Live page] in the Basic screen [Basic] (→ page 104) appears.

19.Gain [Gain]

	Increase the gain of the images.
	Decrease the gain of the images.

<NOTE>

- The current setting is displayed in the middle of the button.

20.White balance [WB]

	Switch the white balance in the order [AWB A], [AWB B], [3200K], [5600K], [VAR], [ATW].
	Switch the white balance in the order [AWB A], [ATW], [VAR], [5600K], [3200K], [AWB B].
	Automatic white balance (AWB) is executed and the white balance is reset.
	Automatic black balance (ABB) is executed and the black balance is reset.

<NOTE>

- The current setting is displayed in the middle of the button.

21.Shutter [Shutter]

	Switch the shutter mode in the order [Off], [Step], [Synchro], [ELC].
	Switch the shutter mode in the order [ELC], [Synchro], [Step], [Off].

<NOTE>

- The current setting is displayed in the middle of the button.

22.ND filter [ND]

	Switch the transmittance of the ND filter in the order [Through], [1/4 ND], [1/16 ND], [1/64 ND].
	Switch the transmittance of the ND filter in the order [1/64 ND], [1/16 ND], [1/4 ND], [Through].

<NOTE>

- The current setting is displayed in the middle of the button.
- ND filter switching is not possible in night mode.

23.SRT/MPEG2-TS/RTMP

	Starts streaming to the transmission destination that was pre-registered. The button turns red during transmission, and transmission stops when the button is clicked again.
	(Streaming)

<NOTE>

- This button can be used only when [Streaming mode] is [RTMP], [SRT(H.264)], [SRT(H.264 UHD)], [SRT(H.265)], [SRT(H.265 UHD)], or [MPEG2-TS over UDP].
- When [Streaming mode] is [SRT(H.264)], [SRT(H.264 UHD)], [SRT(H.265)], or [SRT(H.265 UHD)], transmission can be started by clicking this button only when the Client(Caller) mode is set.

24.Button for switching the personal computer screen

	Display the screen for mobile terminals. For details, refer to "Displaying the web screen using a mobile terminal" (→ page 154).
--	--

<NOTE>

- This button is displayed only when displaying on a mobile terminal.

25.Preset thumbnail list display button

	Display a list of Preset thumbnails on the live screen [Live].
--	--

26.Button for switching real time updating

	Frame dropping in images may be observed depending on the operating performance of the personal computer running the web browser. You can improve this problem by pressing this button to disable the real time updating function. Data items subject to real time updating are as follows. - Zoom - Focus - Iris - Gain - WB - Shutter - ND
--	---

<NOTE>

- The middle-click function is disabled if the button is enabled.

Web screen configurations

Web setup screen [Setup]

The settings for the unit are selected on this screen.

<NOTE>

- The setting menu operations can be performed only by users whose access level is “1.Administrator”. For the procedure used to set the access level, refer to page 130.
- If the value of a setting is changed using the OSD menu or a different web browser, the setting value and the displayed value may not match. In that case, update the setup menu display screen of that web browser.



1. Setting status [Setting status]

The setting status screen [Setting status] is displayed when the button is clicked.

→ “Setting status screen [Setting status]” (→ page 95)

2. Basic settings [Basic]

System button [System]

The system screen [System] is displayed when the button is clicked.

→ “System screen [System]” (→ page 96)

Date&Time button [Date&Time]

The Date & time screen [Date&Time] is displayed when the button is clicked.

→ “Date & time screen [Date&Time]” (→ page 103)

Live page button [Live page]

The live page screen [Live page] is displayed when the button is clicked.

→ “Live page screen [Live page]” (→ page 104)

3. Image screen [Image/Audio]

IP video settings button [Video over IP]

The IP video settings screen [Video over IP] is displayed when the button is clicked.

→ “IP video settings screen [Video over IP]” (→ page 104)

Audio button [Audio]

The audio setting screen [Audio] is displayed when the button is clicked.

→ “Audio setting screen [Audio]” (→ page 114)

Image adjust button [Image adjust]

The image adjust screen [Image adjust] is displayed when the button is clicked.

→ “Image adjust screen [Image adjust]” (→ page 115)

Lens button [Lens]

The Lens setting screen [Lens] is displayed when the button is clicked.

→ “Lens setting screen [Lens]” (→ page 123)

UHD crop button [UHD Crop]

The UHD crop setting screen [UHD Crop] is displayed when the button is clicked.

→ “UHD crop setting screen [UHD Crop]” (→ page 123)

Preset position button [Preset position]

The preset position screen [Preset position] is displayed when the button is clicked.

→ “Preset position screen [Preset position]” (→ page 125)

4. Collaboration capability [Linkage]

Tracking data output setting button [Tracking Data Output]

The tracking data output setting screen [Tracking Data Output] is displayed when the button is clicked.

→ “Tracking data output settings screen [Tracking Data Output]”
 (→ page 127)

P2 Cast connection setting button [P2 Cast]

P2 Cast connection setting screen [P2 Cast] is displayed when the button is clicked.

→ “P2 Cast connection setting screen [P2 Cast]” (→ page 129)

5. User management settings [User mng.]

User authentication button [User auth.]

The user authentication screen [User auth.] is displayed when the button is clicked.

→ “User authentication screen [User auth.]” (→ page 130)

Host authentication button [Host auth.]

The host authentication screen [Host auth.] is displayed when the button is clicked.

→ “Host authentication screen [Host auth.]” (→ page 131)

6. Network settings [Network]

Network setup button [Network]

The network setup screen [Network] is displayed when the button is clicked.

→ “Network setup screen [Network]” (→ page 132)

Advanced network setting button [Advanced]

The advanced network setting screen [Advanced] is displayed when the button is clicked.

→ “Advanced network setting screen [Advanced]” (→ page 135)

7. Maintenance [Maintenance]

System log button [System log]

The system log screen [System log] is displayed when the button is clicked.

→ “System log screen [System log]” (→ page 148)

Product information button [Product Info.]

The product information screen [Product info.] is displayed when the button is clicked.

→ “Product information screen [Product info.]” (→ page 149)

Reset settings button [Default reset]

The reset settings screen [Default reset] is displayed when the button is clicked.

→ “Reset settings screen [Default reset]” (→ page 150)

Back up button [Backup]

The back up screen [Backup] is displayed when the button is clicked.

→ “Back up screen [Backup]” (→ page 151)

8. Power ON button [Power ON]/Standby button [Standby]

<div style="background-color: #333; color: white; padding: 2px; display: inline-block;">Power ON ▾</div> [Power ON]	Turn the unit on.
<div style="background-color: #333; color: white; padding: 2px; display: inline-block;">Standby ▾</div> [Standby]	Set the unit to Standby mode.

When you enter Standby mode, the display will automatically switch to the live screen [Live]. In addition, the [Setup] button in the live screen [Live] will be disabled, and you cannot operate the web setup screen [Setup].

9. Main area

The menu screen is displayed.

Setting status screen [Setting status]

Setting status
Model no.
V01.00
Firmware Version
V01.00
System Frequency
59.94Hz
System Format
2160/59.94p
Streaming mode
H.264

Model no.

The model number of the unit is displayed.

Firmware Version

The firmware version of the unit is displayed.

Refer to the product information screen [Product info.] for detailed version information.

System Frequency

The frame frequency of the unit is displayed.

System Format

The video format of the unit is displayed.

Streaming mode

The streaming mode of the unit is displayed.

Basic screen [Basic]

System screen [System]

System status



Frequency

The frame frequency setting is displayed.

Format

The video format setting is displayed.

Shooting Mode

The shooting mode setting is displayed.

Color Setting

Displays the color (gamma and gamut) setting for the system as a whole.

Genlock

Horizontal Phase

The horizontal phase setting during genlock is displayed.

Wireless Control

The wireless remote control setting is displayed.

Fan

Fan1

The setting for the cooling fan near the lens is displayed.

Fan2

The setting for the cooling fan near the pan-tilt head is displayed.

Output

12G SDI/OPTICAL

The output setting for the 12G SDI OUT connector <12G SDI OUT> is displayed.

3G SDI

The output setting for the 3G SDI OUT connector <3G SDI OUT> is displayed.

MONI

The output setting for the MONITOR OUT connector <MONI OUT> is displayed.

HDMI

The output setting for the HDMI connector <HDMI> is displayed.

Pan/Tilt

Install Position

The install position setting is displayed.

Smart Picture Flip

The smart picture flip setting is displayed.

P/T Speed Mode

The P/T speed mode setting is displayed.

Speed With Zoom Position

The settings for the function to adjust the speed of pan/tilt adjustment are displayed in conjunction with the zoom magnification.

Focus Adjust With PTZ.

The settings for the function to compensate for poor focus when using pan/tilt/zoom are displayed.

Frequency

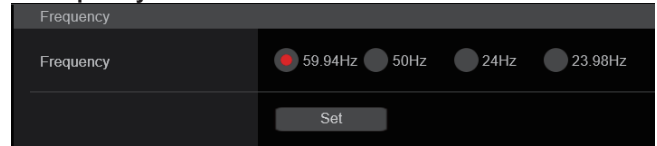

Frequency [59.94Hz, 50Hz, 24Hz, 23.98Hz]

This item is selected to switch the frame frequency. The setting is confirmed with the [Set] button.

Factory settings: 59.94Hz (AW-UE150WP/AW-UE150KP)
50Hz (AW-UE150WE/AW-UE150KE)

<NOTE>

- When the frame frequency is switched, the unit automatically restarts.

Format

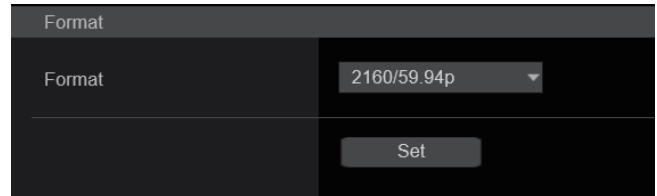

Format

For [59.94Hz]

2160/59.94p, 2160/29.97p, 1080/59.94p, 1080/59.94i, 1080/29.97p, 1080/29.97PsF, 1080/23.98p(59.94i) *1, 720/59.94p

For [50Hz]

2160/50p, 2160/25p, 1080/50p, 1080/50i, 1080/25p, 1080/25PsF, 720/50p

For [24Hz]

2160/24p, 1080/24p

For [23.98Hz]

2160/23.98p, 1080/23.98p, 1080/23.98PsF

The video format is changed on this screen. The setting is confirmed with the [Set] button.

*1 It denotes "1080/23.98p over 59.94i".

<NOTE>

- In order to select [H.264(UHD)], [H.265(UHD)], [JPEG(UHD)], [SRT(H.264 UHD)], and [SRT(H.265 UHD)] in [Streaming mode] for [Video over IP], you need to select the 4K format here.

● Shooting Mode

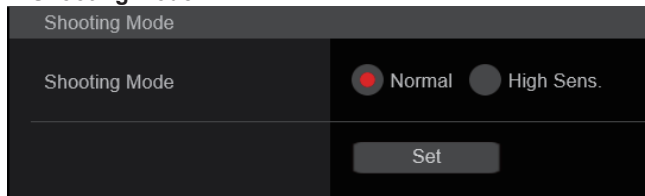

Shooting Mode [Normal, High Sens.]

Select the shooting mode according to the shooting environment. The setting is confirmed with the [Set] button.

Normal	Select when shooting in an environment with a normal level of brightness.
High Sens.	Select high sensitivity shooting. (Suited to shooting in a dark environment)

Factory settings: Normal

● Color Setting

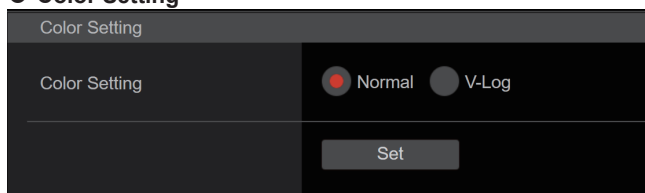

Color Setting [Normal, V-Log]

Set the color (gamma and gamut) for the system as a whole. The setting is confirmed with the [Set] button.

Normal	This setting allows detailed picture quality adjustments on the camera.
V-Log	Set a gamma curve that provides tones and a wide range of latitude (exposure range).

Factory settings: Normal

<NOTE>

- Functions to adjust picture quality are limited when [Color Setting] is [V-Log]. Grading will be necessary after shooting.

● Genlock

This item is selected to perform the phase adjustments. This item's setting is reflected immediately.

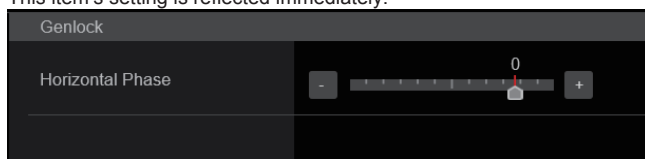

Horizontal Phase [-206 to +49]

This is used to adjust the horizontal phase during genlock.

Factory settings: 0

● Wireless Control

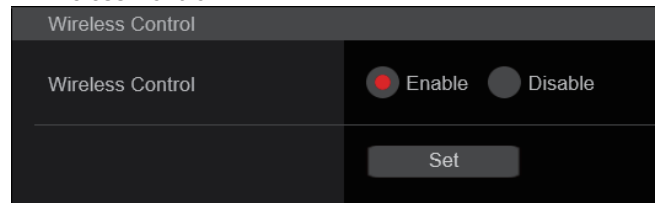

Wireless Control [Enable, Disable]

[Enable] or [Disable] is set here for operations conducted from the wireless remote control.

<NOTE>

When the power is turned on with the wireless remote control, then operations from the wireless remote control are possible irrespective of this setting value.

The setting is confirmed with the [Set] button.

Factory settings: Enable

● Fan

Set the cooling fan operation.

The setting is confirmed with the [Set] button.

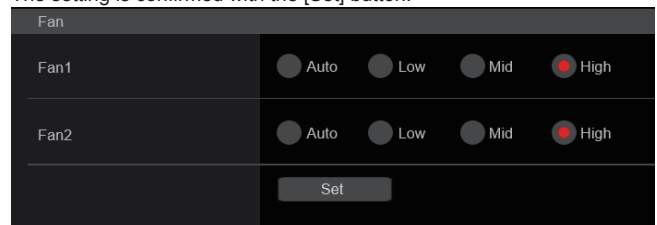

<NOTE>

- Even if this is set to [Low], [Mid], or [High], the cooling fan may be forcibly stopped when the temperature is low.
- Even if this is set to [Low] or [Mid], the cooling fan may be forcibly operated at [High] when the temperature is high.

Fan1 [Auto, Low, Mid, High]

Set the operation of the cooling fan near the lens.

Auto	Enable automatic control of the cooling fan.
Low	Operate the cooling fan at low speed.
Mid	Operate the cooling fan at medium speed.
High	Operate the cooling fan at high speed.

Factory settings: High

Fan2 [Auto, Low, Mid, High]

Set the operation of the cooling fan near the pan-tilt head.

Auto	Enable automatic control of the cooling fan.
Low	Operate the cooling fan at low speed.
Mid	Operate the cooling fan at medium speed.
High	Operate the cooling fan at high speed.

Factory settings: High

● Output

Output

12G SDI/OPTICAL

Format

HDR Output Select SDR HDR(2020) HDR(709)

V-Log Output Select V-Log V-709

3G SDI Out LevelA LevelB

3G SDI

Format

HDR Output Select SDR HDR(2020) HDR(709)

V-Log Output Select V-Log V-709

3G SDI Out LevelA LevelB

MONI

Format

HDR Output Select SDR HDR(2020) HDR(709)

V-Log Output Select V-Log V-709

HDMI

Format

HDR Output Select SDR HDR(2020) HDR(709)

V-Log Output Select V-Log V-709

Video Sampling 4:2:2/10bit 4:2:0/8bit

Bar Camera Colorbar

Color Bar Type Type1 Type2

Tone Off Low Normal

OSD Mix

12G SDI/OPTICAL Off On

3G SDI Off On

MONI Off On

HDMI Off On

IP Off On

OSD Off With R-Tally Off On

OSD Status Off On

Tally Disable Enable

Tally LED Limit

R Unlimit Limit

G Unlimit Limit

Tally Brightness Low Mid High

Status Lamp Disable Enable

External Output

Output1 Off R-Tally G-Tally

Output2 Off R-Tally G-Tally

12G SDI/OPTICAL

Make the settings for output from the 12G SDI OUT connector and Optical connector.

Format

Set the output format.

The following format settings are possible depending on the [Format] setting in the [System] screen.

Frequency	System Format	Format (12G SDI/OPTICAL)
59.94Hz	2160/59.94p	2160/59.94p 1080/59.94p *2
	2160/29.97p	2160/29.97p 1080/29.97p 1080/29.97PsF
	1080/59.94p	1080/59.94p
	1080/59.94i	1080/59.94i
	1080/29.97p	1080/29.97p
	1080/29.97PsF	1080/29.97PsF
	1080/23.98p(59.94i) *1	1080/23.98p(59.94i) *1
	720/59.94p	720/59.94p
50Hz	2160/50p	2160/50p 1080/50p *3
	2160/25p	2160/25p 1080/25p 1080/25PsF
	1080/50p	1080/50p
	1080/50i	1080/50i
	1080/25p	1080/25p
	1080/25PsF	1080/25PsF
	720/50p	720/50p
24Hz	2160/24p	2160/24p 1080/24p
	1080/24p	1080/24p
23.98Hz	2160/23.98p	2160/23.98p 1080/23.98p 1080/23.98PsF
	1080/23.98p	1080/23.98p
	1080/23.98PsF	1080/23.98PsF

*1 It denotes "1080/23.98p over 59.94i".

*2 When [Crop Mode] is [Crop(720)], output is 720/59.94p.

*3 When [Crop Mode] is [Crop(720)], output is 720/50p.

Factory settings: 2160/59.94p (AW-UE150WP/AW-UE150KP)
2160/50p (AW-UE150WE/AW-UE150KE)

Web screen configurations (continued)

HDR Output Select [SDR, HDR(2020), HDR(709)]

Select the signal to be output when [Gamma Mode] is [HLG].

SDR	SDR output
HDR(2020)	HDR output (BT.2020 equivalent color gamut)
HDR(709)	HDR output (BT.709 equivalent color gamut)

Factory settings: HDR(2020)

<NOTE>

- [HDR Output Select] cannot be changed when [Gamma Mode] is other than [HLG] and [Color Setting] is other than [Normal].
(→ page 97, page 120)

V-Log Output Select [V-Log, V-709]

Select the signal to be output when [Color Setting] is [V-Log].

V-Log	Output with a gamma curve that has a wide range of tones and latitude (exposure range).
V-709	Converted for output to images suited to previewing.

Factory settings: V-Log

<NOTE>

- [V-Log Output Select] cannot be changed when [Color Setting] is not [V-Log]. (→ page 97)

3G SDI Out [LevelA, LevelB]

When [Format] (12G SDI/OPTICAL) is [1080/59.94p] or [1080/50p], select the format for outputting 3G SDI signals.

LevelA	Level A format
LevelB	Level B format

Factory settings: LevelA

<NOTE>

- [3G SDI Out] cannot be changed if [Format] (12G SDI/OPTICAL) is other than [1080/59.94p] or [1080/50p].

3G SDI

Make the settings for output from the 3G SDI OUT connector.

Format

Set the output format.

The following format settings are possible depending on the [Format] setting in the [System] screen.

Frequency	System Format	Format (3G SDI)
59.94Hz	2160/59.94p	1080/59.94p *2 1080/59.94i *2
	2160/29.97p	1080/29.97p 1080/29.97PsF
	1080/59.94p	1080/59.94p 1080/59.94i
	1080/59.94i	1080/59.94i
	1080/29.97p	1080/29.97p
	1080/29.97PsF	1080/29.97PsF
	1080/23.98p(59.94i) *1	1080/23.98p(59.94i) *1
50Hz	720/59.94p	720/59.94p
	2160/50p	1080/50p *3 1080/50i *3
	2160/25p	1080/25p 1080/25PsF
	1080/50p	1080/50p 1080/50i
	1080/50i	1080/50i
	1080/25p	1080/25p
	1080/25PsF	1080/25PsF
24Hz	720/50p	720/50p
	2160/24p	1080/24p
23.98Hz	1080/24p	1080/24p
	2160/23.98p	1080/23.98p 1080/23.98PsF
	1080/23.98p	1080/23.98p 1080/23.98PsF

*1 It denotes "1080/23.98p over 59.94i".

*2 When [Crop Mode] is [Crop(720)], output is 720/59.94p.

*3 When [Crop Mode] is [Crop(720)], output is 720/50p.

Factory settings: 1080/59.94p (AW-UE150WP/AW-UE150KP)
1080/50p (AW-UE150WE/AW-UE150KE)

HDR Output Select [SDR, HDR(2020), HDR(709)]

Select the signal to be output when [Gamma Mode] is [HLG].

SDR	SDR output
HDR(2020)	HDR output (BT.2020 equivalent color gamut)
HDR(709)	HDR output (BT.709 equivalent color gamut)

Factory settings: HDR(2020)

<NOTE>

- [HDR Output Select] cannot be changed when [Gamma Mode] is other than [HLG] and [Color Setting] is other than [Normal].
(→ page 97, page 120)

Web screen configurations (continued)

V-Log Output Select [V-Log, V-709]

Select the signal to be output when [Color Setting] is [V-Log].

V-Log	Output with a gamma curve that has a wide range of tones and latitude (exposure range).
V-709	Converted for output to images suited to previewing.

Factory settings: V-Log

<NOTE>

- [V-Log Output Select] cannot be changed when [Color Setting] is not [V-Log]. (→ page 97)

3G SDI Out [LevelA, LevelB]

When [Format] (3G SDI) is [1080/59.94p] or [1080/50p], select the format for outputting 3G SDI signals.

LevelA	Level A format
LevelB	Level B format

Factory settings: LevelA

<NOTE>

- [3G SDI Out] cannot be changed if [Format] (3G SDI) is other than [1080/59.94p] or [1080/50p].

MONI

Make the settings for output from the MONITOR OUT connector <MONI OUT>.

Format

Set the output format.

The following format settings are possible depending on the [Format] setting in the [System] screen.

Frequency	System Format	Format (MONI)
59.94Hz	2160/59.94p	1080/59.94i *2
	2160/29.97p	1080/29.97p 1080/29.97PsF
	1080/59.94p	1080/59.94i
	1080/59.94i	1080/59.94i
	1080/29.97p	1080/29.97p
	1080/29.97PsF	1080/29.97PsF
	1080/23.98p(59.94i) *1	1080/23.98p(59.94i) *1
	720/59.94p	720/59.94p
50Hz	2160/50p	1080/50i *3
	2160/25p	1080/25p 1080/25PsF
	1080/50p	1080/50i
	1080/50i	1080/50i
	1080/25p	1080/25p
	1080/25PsF	1080/25PsF
	720/50p	720/50p
24Hz	2160/24p	1080/24p
	1080/24p	1080/24p
23.98Hz	2160/23.98p	1080/23.98p 1080/23.98PsF
	1080/23.98p	1080/23.98p
	1080/23.98PsF	1080/23.98PsF

*1 It denotes "1080/23.98p over 59.94i".

*2 When [Crop Mode] is [Crop(720)], output is 720/59.94p.

*3 When [Crop Mode] is [Crop(720)], output is 720/50p.

Factory settings: 1080/59.94i (AW-UE150WP/AW-UE150KP)
1080/50i (AW-UE150WE/AW-UE150KE)

HDR Output Select [SDR, HDR(2020), HDR(709)]

Select the signal to be output when [Gamma Mode] is [HLG].

SDR	SDR output
HDR(2020)	HDR output (BT.2020 equivalent color gamut)
HDR(709)	HDR output (BT.709 equivalent color gamut)

Factory settings: SDR

<NOTE>

- [HDR Output Select] cannot be changed when [Gamma Mode] is other than [HLG] and [Color Setting] is other than [Normal]. (→ page 97, page 120)

V-Log Output Select [V-Log, V-709]

Select the signal to be output when [Color Setting] is [V-Log].

V-Log	Output with a gamma curve that has a wide range of tones and latitude (exposure range).
V-709	Converted for output to images suited to previewing.

Factory settings: V-Log

<NOTE>

- [V-Log Output Select] cannot be changed when [Color Setting] is not [V-Log]. (→ page 97)

Web screen configurations (continued)

HDMI

Make the settings for output from the HDMI connector.

Format

Set the output format.

The following format settings are possible depending on the [Format] setting in the [System] screen.

Frequency	System Format	Format (HDMI)
59.94Hz	2160/59.94p	2160/59.94p 1080/59.94p *2
	2160/29.97p	2160/29.97p 1080/29.97p
	1080/59.94p	1080/59.94p
	1080/59.94i	1080/59.94i
	1080/29.97p	1080/29.97p
	1080/29.97PsF	1080/29.97p
	1080/23.98p(59.94i) *1	1080/23.98p(59.94p) *3
50Hz	720/59.94p	720/59.94p
	2160/50p	2160/50p 1080/50p *4
	2160/25p	2160/25p 1080/25p
	1080/50p	1080/50p
	1080/50i	1080/50i
	1080/25p	1080/25p
	1080/25PsF	1080/25p
24Hz	720/50p	720/50p
	2160/24p	2160/24p 1080/24p
23.98Hz	1080/24p	1080/24p
	2160/23.98p	2160/23.98p 1080/23.98p
	1080/23.98p	1080/23.98p
	1080/23.98PsF	1080/23.98p

*1 It denotes "1080/23.98p over 59.94i".

*2 When [Crop Mode] is [Crop(720)], output is 720/59.94p.

*3 It denotes "1080/23.98p over 59.94p".

*4 When [Crop Mode] is [Crop(720)], output is 720/50p.

Factory settings: 2160/59.94p (AW-UE150WP/AW-UE150KP)
2160/50p (AW-UE150WE/AW-UE150KE)

HDR Output Select [SDR, HDR(2020), HDR(709)]

Select the signal to be output when [Gamma Mode] is [HLG].

SDR	SDR output
HDR(2020)	HDR output (BT.2020 equivalent color gamut)
HDR(709)	HDR output (BT.709 equivalent color gamut)

Factory settings: HDR(2020)

<NOTE>

- Other than when [Gamma Mode] is [HLG], [Color Setting] is [Normal], and [Video Sampling] is [4:2:2/10bit], [HDR Output Select] cannot be changed. (→ page 97, page 120)

V-Log Output Select [V-Log, V-709]

Select the signal to be output when [Color Setting] is [V-Log].

V-Log	Output with a gamma curve that has a wide range of tones and latitude (exposure range).
V-709	Converted for output to images suited to previewing.

Factory settings: V-Log

<NOTE>

- [V-Log Output Select] cannot be changed when [Color Setting] is not [V-Log]. (→ page 97)

Video Sampling [4:2:2/10bit, 4:2:0/8bit]

When [Format] in [HDMI] is [2160/59.94p] or [2160/50p], select the video sampling output from the HDMI connector.

4:2:2/10bit	Output in 4:2:2/10bit mode.
4:2:0/8bit	Output in 4:2:0/8bit mode.

Factory settings: 4:2:2/10bit

<NOTE>

- When [Format] in [HDMI] is other than [2160/59.94p] or [2160/50p], [Video Sampling] cannot be changed and is fixed at [4:2:2/10bit].

Bar [Camera, Colorbar]

Switch between camera images and color bars.

Camera	Camera images
Colorbar	Color bar

Factory settings: Camera

Color Bar Type [Type1, Type2]

Select the type of color bar to display.

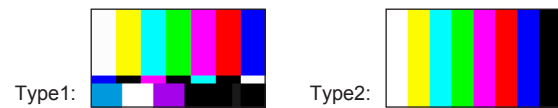

This is only enabled when [Bar] is set to [Colorbar].

Factory settings: Type2

<NOTE>

- Even if the [HDR Output Select] for each of the outputs is either [HDR(2020)] or [HDR(709)], the color bar for SDR is output.

Tone [Off, Low, Normal]

Make the settings for the test tone signal (1 kHz) output while the color bar is displayed.

Off	Test tone is not output.
Low	Test tone is output at low volume.
Normal	Test tone is output at normal volume.

This is only enabled when [Bar] is set to [Colorbar].

Factory settings: Normal

OSD Mix

Select whether to turn off/on camera menu, status, and other displays for each output image.

12G SDI/OPTICAL [Off*, On]

3G SDI [Off*, On]

MONI [Off, On*]

HDMI [Off*, On]

IP [Off, On*]

Off	The camera menus and statuses are not displayed on the output pictures covered by the setting items listed above.
On	The camera menus and statuses are displayed for the output pictures covered by the setting items listed above.

*: **Factory settings**

<NOTE>

- When this is set to [Off], the camera menu can be displayed for about 1 minute after the unit is turned on.

Web screen configurations (continued)

OSD Off With R-Tally [Off, On]

Off or on the function that turns off camera menu, status, and other displays when red tally signals are received via commands or contacts.

When the red tally signal releases, the camera menu display will return.

Factory settings: Off

OSD Status [Off, On]

Turn the status display during AWB and ABB off/on, or error display when an error occurs.

Factory settings: Off

Tally

[Disable, Enable]

[Disable] or [Enable] is set here for the function which turns on or turns off the tally lamp using the tally control signal.

Factory settings: Enable

Tally LED Limit

Sets whether to limit the lighting of the tally lamp for each of the tally control signal colors (R/G).

R [Limit, Unlimit*]

G [Limit, Unlimit*]

Limit	Limit the lighting of the tally lamp.
Unlimit	Light the tally lamp.

*: **Factory settings**

<NOTE>

- If [Disable] is selected for [Tally], the tally status display on external devices (the web screen, controllers such as AW-RP150 and AW-RP60) is also disabled along with the limiting of the tally lamp lighting on this unit.
- If [Limit] is selected for [Tally LED Limit], only lighting of the tally lamp of this unit is limited. The tally status display on external devices (the web screen, controllers such as AW-RP150 and AW-RP60) remains enabled.

Tally Brightness [Low, Mid, High]

Adjust the brightness of the tally LED.

Factory settings: Low

Status Lamp

[Disable, Enable]

[Disable] or [Enable] is set here for the status display lamp.

When you want the status display lamp to stay off while this unit is in operation, set to [Disable].

Factory settings: Enable

<NOTE>

- Even when set to [Disable], the status display lamp may light up when this unit is starting up, updating firmware, or trouble is occurring.

External Output

Select the signal type output from the External Output signal lines (Output1, Output2) of the RS-422 connector. (→ page 16)

Output1 [Off*, R-Tally, G-Tally]

Output2 [Off*, R-Tally, G-Tally]

Off	Signal is not output.
R-Tally	The reception status of the red tally signal is output.
G-Tally	The reception status of the green tally signal is output.

*: **Factory settings**

● Pan/Tilt

The setting is confirmed with the [Set] button.

Install Position

[Desktop, Hanging]

[Desktop] or [Hanging] is selected here as the method used to install the unit.

Desktop	Stand-alone installation
Hanging	Suspended installation

Factory settings: Desktop

<NOTE>

- When [Hanging] has been selected, the top, bottom, left and right of the images will be reversed, and up/down/left/right control for panning and tilting will also be reversed.

Smart Picture Flip

Mode [Off, Auto]

When the tilt becomes the angle set for [Flip Detect Angle], the image will be flipped in the vertical direction automatically.

Off	The picture is not turned upside down.
Auto	The picture is automatically turned upside down.

Factory settings: Off

Flip Detect Angle [60deg to 120deg]

Set the tilt angle at which the image will be flipped in the vertical direction automatically when [Smart Picture Flip] is set to [Auto].

Factory settings: 90deg

P/T Speed Mode [Normal(60deg/s), Fast(180deg/s), Quick(60deg/s)]

Set the speed of pan/tilt operation.

Normal (60deg/s)	Pan/tilt operates at normal speed (maximum about 60° per second).
Fast (180deg/s)	Pan/tilt operates at fast speed (maximum about 180° per second).
Quick (60deg/s)	Pan/tilt operates at normal speed (maximum about 60° per second) and acceleration and deceleration (rise time and fall time) are faster.

Factory settings: Normal(60deg/s)

<NOTE>

- The pan/tilt operation noise may increase when [Fast(180deg/s)] is selected.
- Even when [Fast(180deg/s)] is selected, the pan/tilt speed during preset playback will be the same speed as when [Normal(60deg/s)] is selected.

Web screen configurations (continued)

Speed With Zoom Position [Off, On]

[Off] or [On] is set here for the function used to adjust the pan-tilt adjustment speed in conjunction with the zoom magnification. When [On] is set, the panning and tilting operations will become slower in the zoom status.

This function has no effect during preset operations.

Factory settings: On

Focus Adjust With PTZ. [Off, On]

[Off] or [On] is set here for the function which compensates for out-of-focusing when it occurs during panning, tilting or zooming operations. When [Off] is set, adjust the focus as required after zooming or set [Focus Mode] to [Auto].

This is only enabled when [Manual] has been selected as the [Focus Mode] setting.

Factory settings: Off

Power On Position [None, Standby, Home, Preset]

Select the initial positions for Pan/Tilt/Zoom when the power is turned on.

None	Keep the positions of Pan/Tilt when the power was last on, with Zoom being at the Wide end.
Standby	Move to the Pan/Tilt/Zoom positions they were in the last time the camera was switched to Standby mode.
Home	Pan/Tilt move to their home positions (front) and Zoom goes to the Wide end.
Preset	Preset playback is performed at the preset position specified with [Preset Number].

Factory settings: None

Preset Number [Preset001 to Preset100]

Specify a number for preset playback when the power turns ON when [Preset] is set in [Power On Position].

Factory settings: Preset001

<NOTE>

- If an unregistered preset number is set, preset playback is not performed and the operation is the same as [None].

■ Date & time screen [Date&Time]

Make clock settings.

You can set using one of three types [PC Synchronization], [NTP], or [Manual].

Auto

PC Synchronization

If you click the [Execute] button, the settings are configured by synchronizing the unit to the date and time of the connected personal computer.

<NOTE>

- The time zone of the personal computer is not reflected on the unit. Set the time zone on the unit.

NTP

If you click "NTP>>", the settings screen for the NTP server appears. (→ page 136)

Manual

Date/Time

Configure the settings for the month, day, and year and for the hour, minute, and second.

<NOTE>

- The time is in the 24-hour format.

Time Zone

Selects the time zone according to the region where the camera is being used.

Factory settings:

(GMT) Greenwich Mean Time : Dublin, Edinburgh, Lisbon, London

Live page screen [Live page]

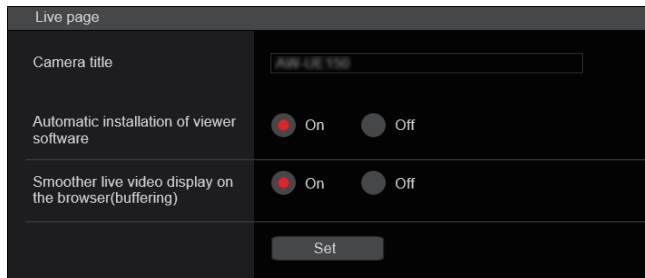

Camera title

Input the name of the camera here.

When the [Set] button is clicked, the input name appears in the camera title display area.

- The factory default setting is the model number of the unit.
- You can enter between 0 to 20 characters.
- The following characters can be displayed.

Numeric characters	0123456789
Alphabetical characters (upper and lower cases)	ABCDEFGHIJKLMNOPQRSTUVWXYZ abcdefghijklmnopqrstuvwxyz
Symbols	!#\$%&'()*+,-./:;<=>?@[]^_`{ }~

Automatic installation of viewer software [On, Off]

Windows I.E.11

One of the following settings is selected for the automatic installation of the plug-in viewer software.

Factory settings: On

Smoother live video display on the browser(buffering)

[On, Off] Windows I.E.11

Configure settings for displaying images from the unit on the plug-in viewer software.

On	Temporarily store images from the unit onto the personal computer for smoother display. However, the screen display images will be displayed later than the actual images.
Off	Do not temporarily store images from the unit onto the personal computer, and display them in real time. However, the motion of the screen display images may not be smooth.

Factory settings: On

Image screen [Image/Audio]

IP video settings screen [Video over IP]

The JPEG image and H.264 image settings as well as the settings related to image quality are selected on this screen.

<NOTE>

- IP control can be performed but if you do not want to perform IP image transmission, set [JPEG transmission], [H.264 transmission], [H.265 transmission], [RTMP transmission], [SRT transmission] and [Ts transmission] to [Off].
- When JPEG image transmission is set to [Off], IP images are not displayed in browsers other than Windows Internet Explorer 11. This includes mobile terminals.

Setting status

Setting status					
Streaming mode					
H.264					
Initial display setting					
H.264(1)					
JPEG(1)	Transmission	Image capture size	Refresh interval	Image quality	
	On	1280-720	30ps	Fine	
JPEG(2)	Transmission	Image capture size	Refresh interval	Image quality	
	On	640-360	30ps	Fine	
JPEG(3)	Transmission	Image capture size	Refresh interval	Image quality	
	On	320-180	30ps	Fine	
H.264(1)	Transmission	Image capture size	Transmission priority	Frame rate	Max. bitrate
	On	1920x1080		30ps	14339.0144Mbps
H.264(2)	Transmission	Image capture size	Transmission priority	Frame rate	Max. bitrate
	On	1280-720		30ps	8192.4096Mbps
H.264(3)	Transmission	Image capture size	Transmission priority	Frame rate	Max. bitrate
	On	640-360		30ps	4096.1024Mbps
H.264(4)	Transmission	Image capture size	Transmission priority	Frame rate	Max. bitrate
	On	640-360		30ps	4096.1024Mbps

Streaming mode

The streaming mode setting is displayed.

Initial display setting

The setting for the image displayed when the live screen [Live] is open.

JPEG

The JPEG transmission settings are displayed.

H.264

The H.264 transmission settings are displayed.

These are not displayed when the [Streaming mode] is [H.265], [H.265(UHD)], [SRT(H.265)] or [SRT(H.265 UHD)].

H.265

The H.265 transmission settings are displayed.

These are only displayed when the [Streaming mode] is [H.265], [H.265(UHD)], [SRT(H.265)] or [SRT(H.265 UHD)].

Web screen configurations (continued)

● Streaming mode

It is possible to perform IP transmission operations suited to the application by switching the [Streaming mode] on this unit. The setting is confirmed with the [Set] button.

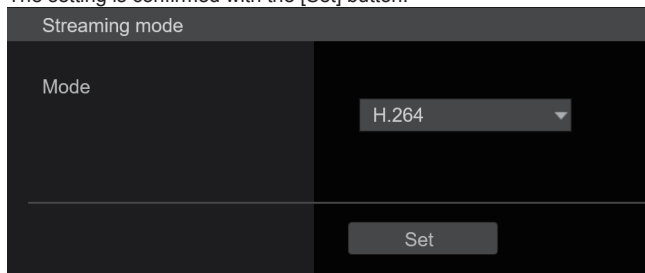

Mode [H.264(UHD), H.264, H.265(UHD), H.265, JPEG(UHD), RTMP, SRT(H.264), SRT(H.264 UHD), SRT(H.265), SRT(H.265 UHD), NDI|HX V2, MPEG2-TS over UDP]

H.264(UHD)	IP videos can be transmitted over multiple channels. 4K images are transmitted via IP in the H.264 format. • 4K images in H.264 format cannot be displayed in the live screen [Live] of the unit. Use external devices and software compatible with 4K images to display 4K images.
H.264	IP videos can be transmitted over multiple channels. Full HD images are transmitted via IP in the H.264 format.
H.265(UHD)	IP videos can be transmitted over multiple channels. 4K images are transmitted via IP in the H.265 format. • 4K images in H.265 format cannot be displayed in the live screen [Live] of the unit. Use external devices and software compatible with 4K images to display 4K images.
H.265	IP videos can be transmitted over multiple channels. Full HD images are transmitted via IP in the H.265 format.
JPEG(UHD)	IP videos can be transmitted over multiple channels. 4K images are transmitted via IP in the JPEG format.
RTMP	H.264 format is transmitted via IP to the RTMP/RTMPS server.
SRT(H.264)	Full HD images are transmitted via IP in the H.264 format to the SRT compatible decoder or service.
SRT(H.264 UHD)	4K images are transmitted via IP in the H.264 format to the SRT compatible decoder or service.
SRT(H.265)	Full HD images are transmitted via IP in the H.265 format to the SRT compatible decoder or service.
SRT(H.265 UHD)	4K images are transmitted via IP in the H.265 format to the SRT compatible decoder or service.
NDI HX V2	Videos are sent to software applications and hardware compatible with NewTek NDI HX over a network.
MPEG2-TS over UDP	IP videos can be transmitted over multiple channels. Full HD images are transmitted via IP in the H.264 format.

Factory settings: H.264

<NOTE>

- When [IP(UDP)] of [Tracking Data Output] is set to [On], video transmission via IP may be delayed or the video may suffer frame loss. (→ page 128)
We recommend setting [IP(UDP)] of [Tracking Data Output] to [Off] to avoid the delay or frame loss due to the video transmission via IP.

● Initial display setting

Set initial display settings for the Live screen [Live]. The setting is confirmed with the [Set] button.

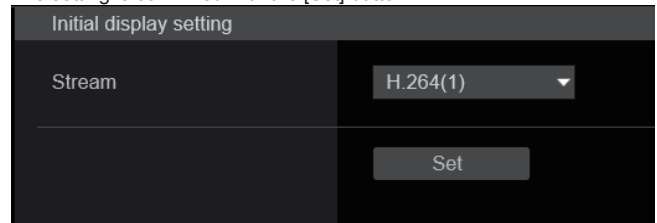

Stream [H.264(1), H.264(2), H.264(3), H.264(4), JPEG(1), JPEG(2), JPEG(3)]

Select the type of images to display in the Live screen [Live].

H.264(1) Windows I.E.11	Display videos (H.264(1)).
H.264(2) Windows I.E.11	Display videos (H.264(2)).
H.264(3) Windows I.E.11	Display videos (H.264(3)).
H.264(4) Windows I.E.11	Display videos (H.264(4)).
JPEG(1)	Display still images (JPEG(1)).
JPEG(2)	Display still images (JPEG(2)).
JPEG(3)	Display still images (JPEG(3)).

Factory settings: H.264(1)

<NOTE>

- This setting may switch automatically according to the [Streaming mode].

Web screen configurations (continued)

● JPEG

Set JPEG image settings.

The setting is confirmed with the [Set] button.

There are a total of 3 channels available for JPEG image setting.

JPEG(1)	
JPEG transmission	<input checked="" type="radio"/> On <input type="radio"/> Off
Image capture size	1280×720
Refresh interval	30fps
Image quality	<input checked="" type="radio"/> Fine <input type="radio"/> Normal
Set	

<NOTE>

- [JPEG(2)] and [JPEG(3)] cannot be set when the [Streaming mode] is [JPEG(UHD)] or [NDI|HX V2].

JPEG transmission [On, Off]

Set whether to transmit JPEG images.

Factory settings: On

Image capture size [3840×2160, 1920×1080, 1280×720, 640×360, 320×180]

When displaying JPEG images, select the resolution for image display from the following.

JPEG(1)	3840×2160, 1920×1080, 1280×720, 640×360, 320×180
JPEG(2)	640×360, 320×180
JPEG(3)	640×360, 320×180

Factory settings:

JPEG(1): 1280×720

JPEG(2): 640×360

JPEG(3): 320×180

<NOTE>

- [3840 x 2160] can be selected when the [Streaming mode] is [JPEG(UHD)].

Refresh interval [1fps, 4fps, 5fps, 12fps, 12.5fps, 15fps, 24fps, 25fps, 30fps]

Select the frame rate for JPEG images.

59.94Hz	1fps/5fps/15fps/30fps
50Hz	1fps/5fps/12.5fps/25fps
24/23.98Hz	1fps/4fps/12fps/24fps

Factory settings:

For 59.94Hz:

JPEG(1): 30fps

JPEG(2): 5fps

JPEG(3): 30fps

For 50Hz:

JPEG(1): 25fps

JPEG(2): 5fps

JPEG(3): 25fps

For 24/23.98Hz:

JPEG(1): 24fps

JPEG(2): 4fps

JPEG(3): 24fps

<NOTE>

- The frame rate may be slower depending on the network environment, resolution, image quality, access volume, etc.
- If images are not transmitted at the specified frame rate, lowering the resolution or image quality may result in transmissions closer to the specified value.

Image quality [Fine, Normal]

Specify the JPEG image quality for each resolution.

Factory settings: Fine

H.264

Set H.264 image settings.

The setting is confirmed with the [Set] button.

H.264(1)	
H.264 transmission	<input checked="" type="radio"/> On <input type="radio"/> Off
Internet mode(Over HTTP)	<input type="radio"/> On <input checked="" type="radio"/> Off
Image capture size	1920×1080
Transmission priority	Frame rate
Frame rate	30fps
Max bit rate(per client)	Max 14336kbps - Min 6144kbps
Image quality	Motion priority
Transmission type	Unicast port(AUTO)
Unicast port(Image)	32004 (1024 - 50000)
Unicast port(Audio)	33004 (1024 - 50000)
Multicast address	239.192.0.20
Multicast port	37004 (1024 - 50000)
Multicast TTL/HOPLimit	16 (1 - 254)
Set	

<NOTE>

- On browsers other than Internet Explorer 11, only JPEG images can be displayed.
- Only [H.264(1)] can be set when the [Streaming mode] is [H.264(UHD)].
- H.264 cannot be set when the [Streaming mode] is [H.265(UHD)], [H.265], [SRT(H.265)], [SRT(H.265 UHD)] or [NDI|HX V2].
- When starting RTSP/RTP transmissions, set the following URLs for the decoders and applications.
 - For H.264(1):
rtsp://[unit's IP address]/MediaInput/h264/stream_1
 - For H.264(2):
rtsp://[unit's IP address]/MediaInput/h264/stream_2
 - For H.264(3):
rtsp://[unit's IP address]/MediaInput/h264/stream_3
 - For H.264(4):
rtsp://[unit's IP address]/MediaInput/h264/stream_4

[/MediaInput/h264/stream_*] can be changed in [RTSP] of [Advanced]. (→ page 138)

H.264 transmission [On, Off]

Whether to transmit the H.264 images is set here.

Factory settings: On

Internet mode(Over HTTP)

[On, Off]

This setting is selected when transmitting H.264 images over the Internet.

H.264 images can be transmitted using the same broadband router settings as when transmitting JPEG images.

On	The H.264 images and audio are transmitted using the HTTP port. For details on setting the HTTP port number, refer to page 133.
Off	The H.264 images and audio are transmitted using the UDP port.

Factory settings: Off

<NOTE>

- When [On] is set, only [Unicast port(AUTO)] can be selected as the [Transmission type] setting.
- When [On] is set, it takes a few seconds before the H.264 images are displayed.
- When this is set to [On], access will be limited to IPv4.

Image capture size [3840×2160, 1920×1080, 1280×720, 640×360, 320×180]

Select the resolution for H.264 images.

Selectable options will vary depending on the selected resolution setting.

H.264(1)	3840×2160, 1920×1080, 1280×720
H.264(2)	1920×1080, 1280×720, 640×360, 320×180
H.264(3)	1280×720, 640×360, 320×180
H.264(4)	1280×720, 640×360, 320×180

Factory settings:

H.264(1): 1920×1080

H.264(2): 1280×720

H.264(3): 640×360

H.264(4): 640×360

<NOTE>

- [3840×2160] can be selected when the [Streaming mode] is [H.264(UHD)].

Transmission priority [Constant bit rate, Frame rate, Best effort]

Set the transmission mode for H.264 images.

Constant bit rate	Transmits H.264 images at the bit rate specified in [Max bit rate(per client)]. • The "Frame rate" value is automatically determined (as 5fps to 30fps or 5fps to 25fps) according to the selected bit rate. (→ page 108)
Frame rate	Transmit H.264 images at the frame rate specified in [Frame rate]. • Set the frame rate and bit rate and transmit. (→ page 107, page 108)
Best effort	Transmit H.264 images at a variable bit rate between the maximum and minimum specified in [Max bit rate(per client)], according to the network bandwidth. • Depending on how the bit rate is changed, the "Frame rate" value is automatically determined (as 5fps to 30fps or 5fps to 25fps). (→ page 108)

Factory settings: Frame rate

<NOTE>

- This cannot be set when the [Streaming mode] is [H.264(UHD)].
- This cannot be set when the frame frequency is 24/23.98Hz.

Frame rate [5fps, 12.5fps, 15fps, 24fps, 25fps, 30fps, 50fps, 60fps]

Set the frame rate for H.264 images.

59.94Hz	5fps/15fps/30fps/60fps
50Hz	5fps/12.5fps/25fps/50fps
24/23.98Hz	24fps

Factory settings:

For 59.94Hz: 30fps

For 50Hz: 25fps

For 24/23.98Hz: 24fps

<NOTE>

- [60fps(50fps)] cannot be selected when the video format is [29.97p(25p)].

Web screen configurations (continued)

Max bit rate(per client)

[512kbps, 768kbps, 1024kbps, 1536kbps, 2048kbps, 3072kbps, 4096kbps, 6144kbps, 8192kbps, 10240kbps, 12288kbps, 12800kbps, 14336kbps, 16384kbps, 20480kbps, 24576kbps, 25600kbps, 51200kbps, 76800kbps]

Specify the H.264 bit rate per client.

When [Transmission priority] is set to [Best effort], specify the maximum and minimum bit rate.

Factory settings:

H.264(1): 14336kbps
 H.264(2): 8192kbps
 H.264(3): 4096kbps
 H.264(4): 4096kbps

<NOTE>

- When the [Streaming mode] is set to [H.264(UHD)], the value is fixed according to the frame rate.
- The setting range depends on the resolution.

Image quality [Motion priority, Image quality priority]

Select the image quality for H.264 images.

Motion priority	Mode giving priority to image motion.
Image quality priority	Mode giving priority to image quality.

Factory settings: Motion priority

<NOTE>

- This setting is only enabled when [Transmission priority] is set to [Constant bit rate] or [Best effort].

Transmission type [Unicast port(AUTO), Unicast port(MANUAL), Multicast]

Select the transmission format for H.264 images.

Unicast port(AUTO)	Up to 14 users can access a single camera at the same time. [Unicast port(Image)] and [Unicast port(Audio)] will be configured automatically when images and audio are sent from the camera. We recommend selecting the [Unicast port(MANUAL)] setting when the port number transmitting the H.264 images does not need to be fixed (e.g., during use within a network).
Unicast port(MANUAL)	Up to 14 users can access a single camera at the same time. [Unicast port(Image)] and [Unicast port(Audio)] must be configured manually when images and audio are sent from the camera. When transmitting H.264 images via the Internet, configure a fixed transmission port for the broadband router (hereafter referred to as "router") (→ page 132). For details, refer to the operating instructions for the router.
Multicast	An unlimited number of users can access a single camera at the same time. When transmitting H.264 images via multicast, enter the [Multicast address], [Multicast port], and [Multicast TTL/HOPLimit].

Factory settings: Unicast port(AUTO)

<NOTE>

- For details on the maximum number for simultaneous access, see page 87.

Unicast port(Image) [1024 to 50000]

Enter the unicast port number (used when sending images from the unit).

Only even numbers can be specified.

The port number cannot be set to 10670.

Factory settings:

H.264(1): 32004
 H.264(2): 32014
 H.264(3): 32024
 H.264(4): 32034

Unicast port(Audio) [1024 to 50000]

Only even numbers can be specified.

The port number cannot be set to 10670.

Factory settings:

H.264(1): 33004
 H.264(2): 33014
 H.264(3): 33024
 H.264(4): 33034

<NOTE>

- The unicast port number must be configured when [Transmission type] is set to [Unicast port(MANUAL)].

Multicast address

[IPv4: 224.0.0.0 to 239.255.255.255]

IPv6: Multicast address starting with FF]

Enter the multicast IP address.

Images and audio will be sent to the specified IP address.

Factory settings:

H.264(1): 239.192.0.20
 H.264(2): 239.192.0.21
 H.264(3): 239.192.0.22
 H.264(4): 239.192.0.23

<NOTE>

- Verify usable multicast IP addresses before entering this setting.

Multicast port [1024 to 50000]

Enter the multicast port number (used when sending images from the unit).

Only even numbers can be specified.

The port number cannot be set to 10670.

Factory settings: 37004

<NOTE>

- When sending audio from the unit, a port number with "1000" added to the multicast port number will be used.

Multicast TTL/HOPLimit [1 to 254]

Enter the TTL/HOPLimit value for multicast.

Factory settings: 16

<NOTE>

- When transmitting H.264 images via the Internet, transmitted images may not appear depending on proxy server settings, firewall settings, etc. In such cases, consult your network administrator.
- When displaying multicast images on a personal computer with multiple LAN cards installed, disable the LAN cards that are not used for reception.

● H.265

Set H.265 image settings.

The setting is confirmed with the [Set] button.

H.265(1)	
H.265 transmission	<input checked="" type="radio"/> On <input type="radio"/> Off
Image capture size	3840x2160
Frame rate	30fps
Max bit rate(per client)	Max 51200kbps
Transmission type	Unicast port(AUTO)
Unicast port(Image)	32004 (1024 - 50000)
Unicast port(Audio)	33004 (1024 - 50000)
Multicast address	239.192.0.20
Multicast port	37004 (1024 - 50000)
Multicast TTL/HOPLimit	16 (1 - 254)
Set	

<NOTE>

- H.265 format images cannot be displayed in the live screen [Live] of the unit.
- Use external devices and software compatible with H.265 images to display H.265 images.
- When starting RTSP/RTP transmissions, set the following URLs for the decoders and applications.
 - For H.265(1):
rtsp://[unit's IP address]/MediaInput/h265/stream_1
 - For H.265(2):
rtsp://[unit's IP address]/MediaInput/h265/stream_2

[/MediaInput/h265/stream_*] can be changed in [RTSP] of [Advanced]. (→ page 138)

H.265 transmission [On, Off]

Whether to transmit the H.265 images is set here.

Factory settings: On

Image capture size [3840×2160, 1920×1080, 1270×720, 640×360]

Select the resolution for H.265 images.

Selectable options will vary depending on the selected resolution setting.

H.265(1)	3840×2160, 1920×1080, 1270×720
H.265(2)	1920×1080, 1270×720, 640×360

Factory settings:

H.265(1): 1920×1080

H.265(2): 1280×720

<NOTE>

- [3840×2160] can be selected when the [Streaming mode] is [H.265(UHD)].

Frame rate [24fps, 25fps, 30fps, 50fps, 60fps]

Set the frame rate for H.265 images.

59.94Hz	30fps, 60fps
50Hz	25fps, 50fps
24/23.98Hz	24fps

Factory settings:

For 59.94Hz: 30fps

For 50Hz: 25fps

For 24/23.98Hz: 24fps

<NOTE>

- [60fps(50fps)] cannot be selected when the video format is [29.97p(25p)].

Max bit rate(per client)

[512kbps, 768kbps, 1024kbps, 1536kbps, 2048kbps, 3072kbps, 4096kbps, 6144kbps, 8192kbps, 10240kbps, 12288kbps, 12800kbps, 14336kbps, 16384kbps, 20480kbps, 24576kbps, 25600kbps, 51200kbps, 76800kbps]

Specify the H.265 bit rate per client.

Factory settings:

H.265(1): 14336kbps

H.265(2): 8192kbps

Transmission type

The same as H.264 Transmission type (→ page 108).

Unicast port(Image)

The same as H.264 Unicast port(Image) (→ page 108).

Unicast port(Audio)

The same as H.264 Unicast port(Audio) (→ page 108).

Multicast address

The same as H.264 Multicast address (→ page 108).

Multicast port

The same as H.264 Multicast port (→ page 108).

Multicast TTL/HOPLimit

The same as H.264 Multicast TTL/HOPLimit (→ page 108).

Web screen configurations (continued)

● RTMP

Make RTMP/RTMPS transmission settings.

Server setup

The setting is confirmed with the [Set] button.

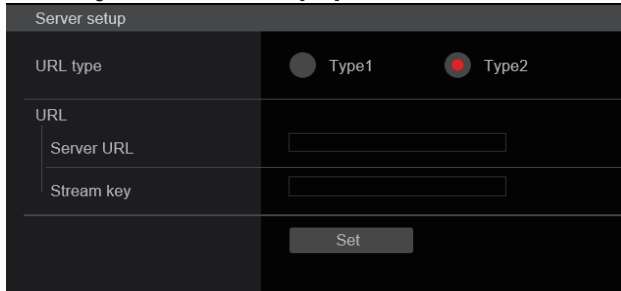

<NOTE>

- Switch to the appropriate method of registering RTMP/RTMPS transmission server information suited to the setting information notified from the RTMP/RTMPS transmission server you are using.
- The Stream Key setting field is displayed only when [Type2] is set.

URL type [Type1, Type2]

Select the method for registering the information for the RTMP/RTMPS transmission server.

Type1	Specify to set the server URL and RTMP/RTMPS stream key as a set in [Server URL].
Type2	Specify to individually set the server URL and RTMP/RTMPS stream key in [Server URL] and [Stream Key].

URL

Server URL

Set the URL for the RTMP/RTMPS server to be transmitted to.

Stream key

The stream key obtained from the RTMP/RTMPS server is set during streaming only when the service is set to [Type2].

Streaming format

Make settings for H.264 images for use in RTMP/RTMPS transmission.

The setting is confirmed with the [Set] button.

Refer to the explanation for H.264 (→ page 107) for information about Image capture size, Frame rate and Max bit rate(per client).

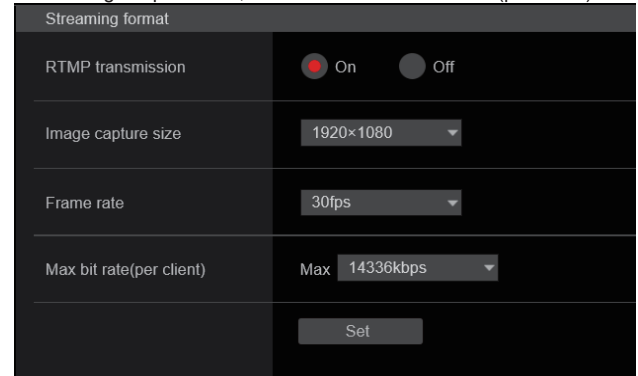

<NOTE>

- Streaming format settings cannot be changed during RTMP/RTMPS transmissions.
- Set the Streaming format to the settings recommended for the transmission destination server. Visit the publisher's website or contact them about the recommended values.
- When [IP(UDP)] of [Tracking Data Output] is set to [On], video transmission via IP may be delayed or the video may suffer frame loss. (→ page 128)
We recommend [IP(UDP)] of [Tracking Data Output] is set to [Off] during RTMP/RTMPS transmission.

Web screen configurations (continued)

● SRT

Make SRT transmission settings.

<NOTE>

- When starting SRT transmissions in the [Listener] mode, set the decoder and application to [Client(Caller)] mode and set the following URL:
srt://[unit's IP address]:[value set in Client(Caller) port]
- When performing SRT transmissions in the [Client(Caller)] mode, set the IP address and port number of the decoder and application to [Destination IP address(IPv4)] and [Destination port], and then click the [start] button for [SRT/MPEG2-TS/RTMP] in the live screen [Live].

Common setup

The setting is confirmed with the [Set] button.

Mode [Client(Caller), Listener]

Selects the method to connect to the SRT compatible decoder or service.

Client(Caller)	Specify the transmission destination IP address and port number when starting transmission from this unit.
Listener	Specify the listener port when awaiting the external request to start transmission.

Factory settings: Listener

Destination IP address(IPv4)

When [Client(Caller)] is set in [Mode], enter the IP address. Images and audio will be sent to the specified IP address.

Factory settings: 192.168.0.3

<NOTE>

- Only IPv4 can be set as the IP address.

Destination port [1024 to 50000]

When [Client(Caller)] is set in [Mode], enter the port number (used when transmitting images from this unit). Connection is to the specified port number.

Factory settings: 7002

Stream ID

When [Client(Caller)] is set in [Mode], enter the Stream ID.

The information entered is notified to the connection destination when SRT transmission is started.

If the [InsertTemplate] button is clicked, the following template is inserted in the input fields.

#!::m=publish,r=PanasonicStream

- The following characters can be displayed.

Numeric characters	0123456789
Alphabetical characters (upper and lower cases)	ABCDEFGHIJKLMNOPQRSTUVWXYZabcdefghijklmnopqrstuvwxyz
Symbols	!#\$%&'()*~^^\` @[]*:+;<>,.?^_

Factory settings: #!::m=publish,r=PanasonicStream

Client(Caller) port [1 to 65535]

When [Listener] is set in [Mode], enter the port number (used when this unit is waiting for a connection).

The following port numbers are used by the unit so they cannot be used.

20, 21, 23, 25, 42, 53, 67, 68, 69, 80, 110, 123, 161, 162, 443, 546, 547, 554, 995, 5960 to 5985, 7960 to 8060, 10669, 10670, 11900, 59000 to 61000

Factory settings: 2020

TTL/HOP Limit

The same as H.264 Multicast TTL/HOPLimit (→ page 108).

Latency

Sets the time between when images and audio are sent and when they are played on the receiving device in a range between 0 and 99999 (ms).

Factory settings: 120

<NOTE>

- In some cases, the set time is not guaranteed depending on the network band.

Encryption [Off, AES-128, AES-256]

Sets whether to encrypt the transmitted IP image. (10 to 24 characters)

Off	Transmits unencrypted IP images.
AES-128	Encrypts IP images in AES-128 before transmitting.
AES-256	Encrypts IP images in AES-256 before transmitting.

Factory settings: Off

- The following characters can be displayed.

Numeric characters	0123456789
Alphabetical characters (upper and lower cases)	ABCDEFGHIJKLMNOPQRSTUVWXYZabcdefghijklmnopqrstuvwxyz
Symbols	_-

Passphrase

Sets the phrase used for decoding the encrypted IP images.

Streaming format

Makes settings for H.264 or H.265 images for use in SRT transmission.

The setting is confirmed with the [Set] button.

Refer to the explanation for H.264 (→ page 107) or H.265 (→ page 109) for information about Image capture size, Frame rate and Max bit rate(per client).

<NOTE>

- Streaming format settings cannot be changed during SRT transmissions.
- When [IP(UDP)] of [Tracking Data Output] is set to [On], video transmission via IP may be delayed or the video may suffer frame loss. (→ page 128)
We recommend [IP(UDP)] of [Tracking Data Output] is set to [Off] during SRT transmission.
- When the frame frequency is 24/23.98Hz, you cannot set to the SRT(H.264), SRT(H.264 UHD), SRT(H.265), or SRT(H.265 UHD) modes.

Web screen configurations (continued)

● NDI|HX V2

Make NDI|HX V2 transmission settings.
The setting is confirmed with the [Set] button.

NDI|HX V2

<NOTE>

- This unit restarts when [Streaming mode] is changed to [NDI|HX V2], or when changed from [NDI|HX V2] to another mode.

Source name

Sets the device name displayed when this unit is detected by software applications and hardware compatible with NDI|HX.

Factory settings: NDI_Device-[serial number of this unit]

Maximum number of characters	1 to 32 characters
Characters that can be entered	Alphanumeric characters, symbols: - _

Protocol [TCP, UDP]

Sets the format of unicast transmission to be used.

Factory settings: TCP

Multicast Transmit [On, Off]

Sets whether to perform multicast transmissions of images for software applications and hardware that are compatible with NDI.

Factory settings: Off

Address(IPv4) [IPv4 : 244.0.0.0 to 239.255.255.255]

Enter the multicast IP address.

Images and audio are transmitted to the specified multicast address.

Factory settings: 239.192.0.30

<NOTE>

- Check the multicast IP addresses available for use before entering.

Subnet(IPv4)

Enter the subnet mask.

Factory settings: 244.0.0.0

<NOTE>

- [Address (IPv4)] and [Subnet (IPv4)] clarify the multicast address ranges randomly set during multicast transmissions.
- When [Address (IPv4)] is set to [239.255.0.0] and [Subnet (IPv4)] is set to [255.255.0.0], the selection is made randomly in the range between [239.255.0.0] and [239.255.255.255].
- To use the IP address set in [Address (IPv4)], set [Subnet (IPv4)] to [255.255.255.255].

TTL/HOP Limit

The same as the H.264 [Multicast TTL/HOPLimit] (→ page 108) .

Group [Enable, Disable]

Sets whether to use the grouping function when performing NDI transmission.

Factory settings: Disable

Name

Sets the group name for use when the grouping function is used.

Maximum number of characters	1 to 32 characters
Characters that can be entered	Alphanumeric characters

Use discovery server

Sets whether to use the discovery server when performing NDI transmission.

Server address(IPv4)

Sets the IPv4 address of the server when using the discovery server.

Streaming format

Make settings for H.264 images used for NDI|HX V2 transmission. Confirm the settings with the [Set] button.

Refer to the description of H.264 (→ page 107) for information about [Image capture size], [Frame rate], and [Max bit rate(per client)].

Web screen configurations (continued)

● MPEG2-TS over UDP

Make settings for MPEG2-TS over UDP transmission.

<NOTE>

- In order to receive the images being transmitted by the camera, enter the following URL in the application or service.
 - For Unicast
udp://@[unicast ipaddress]:[unicast port]
 - For Multicast
udp://@[multicast ipaddress]:[multicast port]

Common setup	
Transmission type	Unicast
Unicast address(IPv4)	
Unicast Port	0 (1024 - 50000)
Multicast address(IPv4)	
Multicast Port	0 (1024 - 50000)
Multicast TTL/HOPLimit	0 (1 - 254)
Push UDP	<input checked="" type="radio"/> Enable <input type="radio"/> Disable
<input type="button" value="Set"/>	

Transmission type [Unicast, Multicast]

Sets the transmission type for MPEG2-TS over UDP transmission as either Unicast or Multicast.

Factory settings: Unicast

Unicast address(IPv4)

Sets the Unicast address used for MPEG2-TS over UDP transmission.

Specify this IP address on the receiving application or service.

Factory settings: 192.168.0.3

Unicast Port [1024 to 50000]

Sets the Unicast port number used for MPEG2-TS over UDP transmission.

Specify this port number on the receiving application or service.

Factory settings: 7002

Multicast address(IPv4)

Sets the Multicast address used for MPEG2-TS over UDP transmission.

Specify this IP address on the receiving application or service.

Factory settings: 239.192.0.20

Multicast Port [1024 to 50000]

Sets the Multicast port number used for MPEG2-TS over UDP transmission.

Specify this port number on the receiving application or service.

Factory settings: 32004

Multicast TTL/HOPLimit

The same as H.264 Multicast TTL/HOPLimit (→ page 108).

Push UDP [Enable, Disable]

When [Push UDP] has been set to [Enable], MPEG2-TS over UDP transmission starts automatically when the camera is started.

Factory settings: Enable

Streaming format

Make settings for H.264 images used for MPEG2-TS over UDP transmission.

The setting is confirmed with the [Set] button.

Refer to the description of H.264 (→ page 107) for information about Image capture size, Frame rate, and Max bit rate(per client).

Streaming format	
Ts transmission	<input checked="" type="radio"/> On <input type="radio"/> Off
Image capture size	1920x1080
Frame rate	30fps
Max bit rate(per client)	Max 14336kbps
<input type="button" value="Set"/>	

<NOTE>

- Streaming format settings cannot be changed during MPEG2-TS over UDP transmissions.
- When [IP(UDP)] of [Tracking Data Output] is set to [On], video transmission via IP may be delayed or the video may suffer frame loss. (→ page 128)
We recommend [IP(UDP)] of [Tracking Data Output] is set to [Off] during MPEG2-TS over UDP transmission.

■ Audio setting screen [Audio]

Configure audio settings.

<NOTE>

- Images and audio are not synchronized. Therefore, images and audio may be slightly out of sync.
- The audio may skip depending on the network environment.

● Setting status

Setting status				
Audio	Audio	Input Type	Volume Level	Plugin Power
	Off	Line	0dB	Off
Audio over IP	Audio transmission	Audio bit rate		
	On	128kbps		

Audio

Audio

The setting status of audio input is displayed.

Input Type

The setting status of the audio input type is displayed.

Volume Level

The setting status of audio output volume is displayed.

Plugin Power

The setting status of audio plugin power is displayed.

Audio over IP

Audio transmission

The setting status of audio data IP transmission is displayed.

Audio bit rate

The bit rate setting status for audio data via IP transmission is displayed.

● Audio

The setting is confirmed with the [Set] button.

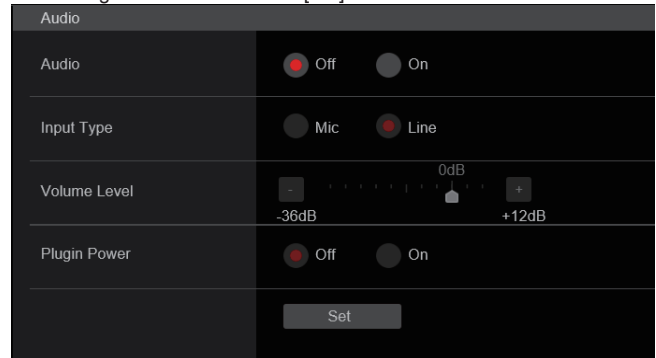

Audio

[Off, On]

Turn audio input off/on.

Factory settings: Off

Input Type [Mic, Line]

Mic	Set the microphone input.
Line	Set the line input.

This is only enabled when [Audio] is set to [On].

Factory settings: Line

Volume Level [-36dB to +12dB]

Set the volume of audio output.

This is only enabled when [Audio] is set to [On].

Factory settings: 0dB

Plugin Power [Off, On]

Turn the plugin power for the audio off/on.

This is only enabled when [Audio] is set to [On].

This is only enabled when [Input Type] is set to [Mic].

Factory settings: Off

● Audio over IP

The setting is confirmed with the [Set] button.

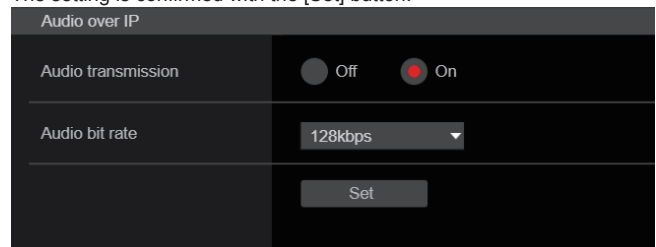

Audio transmission [Off, On]

Set the communication mode used to transmit audio data to a personal computer, etc.

Off	Do not transmit audio data. All settings and controls related to audio will be disabled.
On	Transmit audio data. This allows audio as well as images to be viewed on the personal computer.

Factory settings: On

Audio bit rate [64kbps, 96kbps, 128kbps]

Set the bit rate for transmitting audio.

Factory settings: 128kbps

Image adjust screen [Image adjust]

Adjust the image quality.

The settings in this screen (with the exception of [Scene] and [Matrix]) are applied immediately. After selecting the settings for [Scene] and [Matrix], you need to press the [Set] button to execute.

Scene [Scene1, Scene2, Scene3, Scene4]



Switch the shooting mode depending on the shooting environment. Select a shooting mode based on the shooting conditions or preference.

Select a shooting mode from the pull-down menu, and click the [Set] button to switch to the selected mode.

Scene1	Modes that allow you to adjust detailed settings manually for various shooting conditions and preferences.
Scene2	
Scene3	
Scene4	

Factory settings: Scene1

Camera control/Setup Menu button

Camera control >>

Setup Menu <<

You can display the camera control screen by clicking the [Camera control] button.

You can control the camera while adjusting the image quality.

Brightness

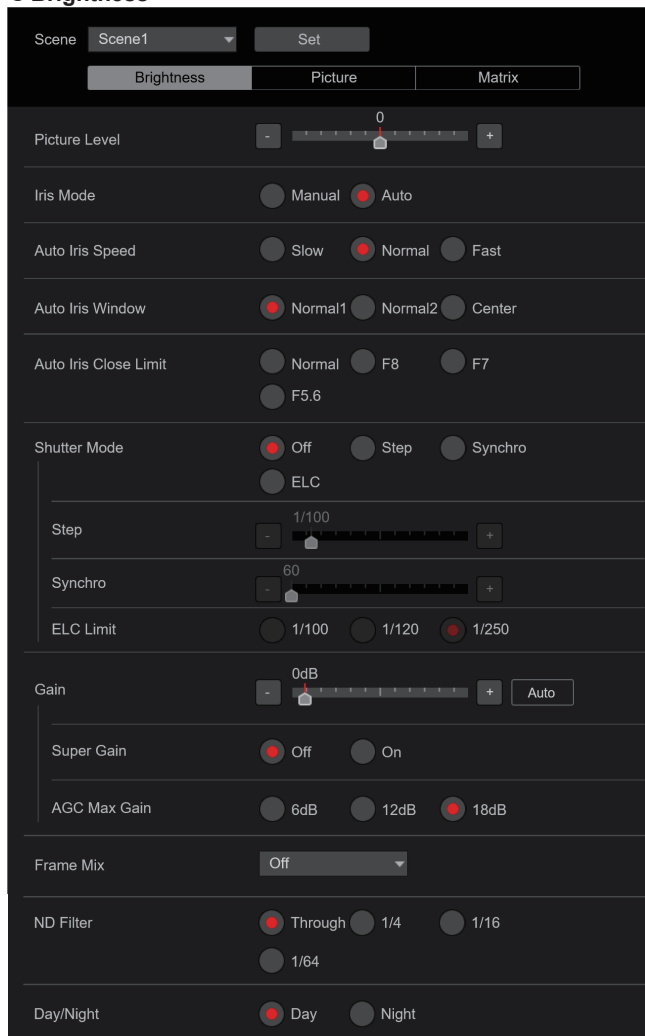

Picture Level [-50 to +50]

This menu item is selected to set the target picture level for automatic exposure compensation.

Its setting takes effect when [Auto] or [ELC] has been selected as the setting for any of the following automatic exposure compensation functions.

- When [Iris Mode] is set to [Auto]
- When [Shutter Mode] is set to [ELC]
- When [Gain] is set to [Auto]

Factory settings: 0

Iris Mode [Manual, Auto]

This menu item is used to select whether the iris is to be adjusted automatically or manually.

Manual	The iris is adjusted manually.
Auto	Auto exposure compensation is performed so that the target level which was set using [Picture Level] is reached.

Factory settings: Auto

Auto Iris Speed [Slow, Normal, Fast]

Set the control speed of the auto iris function.

Slow	Control the iris at a slow speed.
Normal	Control the iris at a normal speed.
Fast	Control the iris at a fast speed.

Factory settings: Normal

Auto Iris Window [Normal1, Normal2, Center]

Select the detection window for the auto iris.

Normal1	Window towards the center of the screen.
Normal2	Window towards the bottom of the screen.
Center	Spotted window in the center of the screen.

Factory settings: Normal1

Auto Iris Close Limit [Normal, F8, F7, F5.6]

Sets the limit value for the CLOSE side in auto iris.

Normal	Moves up to the normal position (the vicinity of F9).
F8	The limit is in the vicinity of F8.
F7	The limit is in the vicinity of F7.
F5.6	The limit is in the vicinity of F5.6.

Factory settings: Normal

Web screen configurations (continued)

Shutter Mode [Off, Step, Synchro, ELC]

Select for camera shutter mode.

Off	The shutter is set to OFF.
Step	The step shutter is set (the steps can be changed).
Synchro	The synchro shutter is set (the setting can be changed continuously).
ELC	The electronic shutter is controlled and the light quantity is adjusted automatically.

Factory settings: Off

Step/Synchro

This is used to adjust the shutter speed in the mode which was selected as the [Shutter Mode] setting.

When a higher shutter speed is selected, fast-moving subjects do not become blurred easily but the images will be darker.

The shutter speeds that can be set are listed below.

	When [Step] is selected as the [Shutter Mode]	When [Synchro] is selected as the [Shutter Mode]
59.94p/59.94i mode	1/60, 1/100, 1/120, 1/250, 1/500, 1/1000, 1/2000, 1/4000, 1/8000, 1/10000	60.0 Hz to 7200 Hz
29.97p mode	1/30, 1/60, 1/100, 1/120, 1/250, 1/500, 1/1000, 1/2000, 1/4000, 1/8000, 1/10000	30.0 Hz to 7200 Hz
23.98p/24p mode	1/24, 1/48, 1/60, 1/100, 1/120, 1/250, 1/500, 1/1000, 1/2000, 1/4000, 1/8000, 1/10000	24.0 Hz to 7200 Hz
50p/50i mode	1/60, 1/100, 1/120, 1/250, 1/500, 1/1000, 1/2000, 1/4000, 1/8000, 1/10000	50.0 Hz to 7200 Hz
25p mode	1/25, 1/50, 1/60, 1/100, 1/120, 1/250, 1/500, 1/1000, 1/2000, 1/4000, 1/8000, 1/10000	25.0 Hz to 7200 Hz

Factory settings:

When [Shutter Mode] is set to [Step]

[59.94Hz] 1/100 [50Hz] 1/120

When [Shutter Mode] is set to [Synchro]

[59.94Hz] 60.0Hz [50Hz] 50.0Hz

<NOTE>

- When [Shutter Mode] is set to [Off] in 29.97p, 23.98p/24p, or 25p mode, the shutter speed is set to [1/50].

ELC Limit [1/100, 1/120, 1/250]

Set the maximum shutter level when ELC is operating.

Factory settings: 1/250

Gain

[When [Super Gain] is [Off]: Auto, -3dB to 36dB,

When [Super Gain] is [On]: Auto, -3dB to 42dB]

The image gain is adjusted here.

In locations which are too dark, adjust the gain upward; conversely, in locations which are too bright, adjust it downward.

When [Auto] is set, the light quantity is adjusted automatically.

The noise increases when the gain is increased.

Factory settings: 0dB

Super Gain [Off, On]

Set the super gain (increased sensitivity) mode.

Off	Do not set super gain mode.
On	Set super gain mode.

Factory settings: Off

AGC Max Gain [6dB, 12dB, 18dB]

When [Auto] is selected as the [Gain] setting, the maximum gain-up amount can be set.

Factory settings: 18dB

Frame Mix [Off, 6dB, 12dB, 18dB, 24dB]

Select for frame addition (gain-up using sensor storage) amount.

Its setting takes effect when [Off] has been selected as the [Shutter Mode] setting (→ page 116).

When frame addition is performed, it will appear as if the images are missing some frames.

This cannot be configured when the format is 2160/29.97p, 2160/23.98p, 2160/24p, 2160/25p, 1080/29.97p, 1080/23.98p(59.94i), 1080/23.98p, 1080/24p, 1080/29.97PsF, 1080/23.98PsF, 1080/25p or 1080/25PsF.

Factory settings: Off

<NOTE>

- Under discharge tube illumination, such as fluorescent and mercury-vapor lights, the brightness may change synchronously, colors may change, and horizontal stripes may flow up and down the image.

ND Filter [Through, 1/4, 1/16, 1/64]

Set the transmittance of the lens' built-in ND (neutral density) filter.

The filter switches when the setting is fixed.

Through	Do not set ND filter.
1/4	Set ND filter transmittance to 1/4.
1/16	Set ND filter transmittance to 1/16.
1/64	Set ND filter transmittance to 1/64.

Factory settings: Through

Day/Night

[Day, Night]

Switch between standard shooting and night-vision shooting (shooting with infrared light).

Day	Standard shooting (day mode)
Night	Night-vision shooting (night mode)

This cannot be set when the [Color Setting] is [V-Log].

Factory settings: Day

<NOTE>

- In night mode, video output will be in black and white. In addition, the iris will be forcibly opened.
- White balance adjustment is not possible in night mode.
- ND filter switching is not possible in night mode.
- [Pedestal] cannot be performed properly in night mode.

● Picture

Brightness Picture Matrix

White Balance Mode ATW AWB A AWB B
 3200K 5600K VAR

AWB

Color Temperature

R Gain

B Gain

Color Temperature Setting

Color Temperature

R Gain

B Gain

G Axis

AWB Gain Offset Off On

ATW Speed Slow Normal Fast

ATW Target R

ATW Target B

Chroma Level

Chroma Phase

ABB

Master Pedestal

R Pedestal

G Pedestal

B Pedestal

Pedestal Offset Off On

Detail Off On

Master Detail

Detail Coring

V Detail Level

Detail Frequency

Level Depend.

Knee Aperture Level

Detail Gain(+)

Detail Gain(-)

Skin Detail Off On

Skin Detail Effect

DownCon Detail Off On

DC. Master Detail

DC. Detail Coring

DC. V Detail Level

DC. Detail Frequency

DC. Level Depend.

DC. Knee Aperture Level

Gamma Mode

Gamma

F-REC Dynamic Level

F-REC Black STR. Level

V-REC Knee Slope

V-REC Knee Point

Black Gamma

Black Gamma Range

DRS Off Low Mid High

Knee Mode Off Auto Manual

Auto Knee Response

Knee Point

Knee Slope

HLG Knee Off On

HLG Knee Point

HLG Knee Slope

White Clip Off On

White Clip Level

DNR Off Low High

White Balance Mode

[ATW, AWB A, AWB B, 3200K, 5600K, VAR]

Set the white balance mode.

Select the mode when the coloring is not natural because of the nature of the light source or other factors.

If the white color serving as the reference can be recognized, subjects can be shot with natural coloring.

ATW	In this mode, the white balance is compensated for automatically, even if changes occur in the light source or color temperature, by a process of continuous and automatic adjustment.
AWB A AWB B	When [AWB A] or [AWB B] is selected and the white balance is executed, the adjustment results obtained are stored in the memory selected. When [AWB A] or [AWB B] is then selected, the white balance stored in the selected memory can be recalled.
3200K	This is the white balance mode which is ideal when a 3200K halogen light is used as the light source.
5600K	This is the white balance mode which is ideal when 5600K sunlight or fluorescent lighting is used as the light source.
VAR	You can specify a color temperature between 2000K to 15000K.

Factory settings: AWB A

AWB

When the [Execute] button is clicked, automatic white balance (AWB) is executed and the white balance is reset.

Color Temperature [2000K to 15000K]

You can specify a color temperature between 2000K to 15000K.

Its setting takes effect when [VAR] has been selected as the [White Balance Mode] setting.

Factory settings: 3200K

R Gain [–200 to +200]

This enables the R gain to be adjusted.

Its setting takes effect when [AWB A], [AWB B] or [VAR] has been selected as the [White Balance Mode] setting.

Factory settings: 0

B Gain [–200 to +200]

This enables the B gain to be adjusted.

Its setting takes effect when [AWB A], [AWB B] or [VAR] has been selected as the [White Balance Mode] setting.

Factory settings: 0

Color Temperature Setting

Color Temperature [2000K to 15000K]

This displays the color temperature when [White Balance Mode] is [AWB A] or [AWB B].

Varying the output balance of Rch and Bch enables the varying of the color temperature.

Varying [R Gain] and [B Gain] in [Color TEMP. Setting] also enables color temperature adjustments.

Its setting takes effect when [AWB A] or [AWB B] has been selected as the [White Balance Mode] setting.

Factory settings: 3200K

R Gain [–400 to +400]

This enables adjustments to R Gain when [White Balance Mode] is [AWB A] or [AWB B].

Varying the output of Rch enables the varying of the colors on the Rch axis.

Its setting takes effect when [AWB A] or [AWB B] has been selected as the [White Balance Mode] setting.

Factory settings: 0

B Gain [–400 to +400]

This enables adjustments to B Gain when [White Balance Mode] is [AWB A] or [AWB B].

Varying the output of Bch enables the varying of the colors on the Bch axis.

Its setting takes effect when [AWB A] or [AWB B] has been selected as the [White Balance Mode] setting.

Factory settings: 0

G Axis [–400 to +400]

This enables adjustments to G Axis when [White Balance Mode] is [AWB A] or [AWB B].

Varying the output of Rch and Bch enables the varying of the colors on the G axis.

Its setting takes effect when [AWB A] or [AWB B] has been selected as the [White Balance Mode] setting.

Factory settings: 0

AWB Gain Offset [Off, On]

When auto white balance is performed by setting [White Balance Mode] to [AWB A] or [AWB B], set the values for Rch gain and Bch gain.

Off	Set the value of [R Gain] and [B Gain] to [0].
On	Maintain the value set in [R Gain] and [B Gain].

Factory settings: Off

ATW Speed [Slow, Normal, Fast]

Set the control speed of the ATW function.

Slow	Tracks at a speed slower than [Normal].
Normal	Tracks at normal speed.
Fast	Tracks at a speed faster than [Normal].

This is only enabled when [White Balance Mode] is set to [ATW].

Factory settings: Normal

ATW Target R [-10 to +10]

Make fine adjustments to the Rch output when converging with the auto tracking white balance operation.

Factory settings: 0

ATW Target B [-10 to +10]

Make fine adjustments to the Bch output when converging with the auto tracking white balance operation.

Factory settings: 0

Chroma Level [Off, -99% to 99%]

Set here the color intensity (chroma level) of the images.

This cannot be set when the [Color Setting] is [V-Log].

Factory settings: 0%

Chroma Phase [-31 to +31]

Make fine adjustments to the hue of the colors in the images.

This cannot be set when the [Color Setting] is [V-Log].

Factory settings: 0

ABB

When the [Execute] button is clicked, automatic black balance (ABB) is executed and the black balance is reset.

Master Pedestal [-200 to +200]

This item is used to adjust the black level (adjust the pedestal).

These parts become darker when a negative setting is selected and, conversely, lighter when a positive setting is selected.

This cannot be set when the [Color Setting] is [V-Log].

All of the following Master Pedestal items also cannot be set when [Color Setting] is [V-Log].

Factory settings: 0

R Pedestal [-100 to +100]

This enables the R pedestal to be adjusted.

Factory settings: 0

G Pedestal [-100 to +100]

This enables the G pedestal to be adjusted.

Factory settings: 0

B Pedestal [-100 to +100]

This enables the B pedestal to be adjusted.

Factory settings: 0

Pedestal Offset [Off, On]

Set the pedestal level of the Rch, Gch, and Bch when the auto black balance has been adjusted.

Off	Set the pedestal level to [0] for [R Pedestal], [G Pedestal], and [B Pedestal].
On	Maintain the values set for each of [R Pedestal], [G Pedestal], and [B Pedestal].

Factory settings: Off

Detail [Off, On]

Turn on/off the contour (sharpness of images) adjustment of images.

This cannot be set when the [Color Setting] is [V-Log].

All of the following Detail items also cannot be set when [Color Setting] is [V-Log].

Factory settings: On

Master Detail [-31 to +31]

Adjust the contour correction level (master).

This is only enabled when [Detail] is set to [On].

Factory settings: 0

Detail Coring [0 to 60]

Set the level of the signal (including noise) which makes the detail effect not work.

This is only enabled when [Detail] is set to [On].

Factory settings: 15

V Detail Level [-7 to +7]

Adjust the contour correction level in the vertical direction.

This is only enabled when [Detail] is set to [On].

Factory settings: 0

Detail Frequency [-7 to +7]

Set the boost frequency of detail.

-7: Low frequency

to

+7: High frequency

When a high frequency is selected, the detail effect is added to subjects with more definition.

This is only enabled when [Detail] is set to [On].

Factory settings: 0

Level Depend. [-7 to +7]

When the detail of bright signals are emphasized, the detail of dark parts are compressed.

The larger the [Level Depend.] setting, the more detail of bright parts is compressed.

This is only enabled when [Detail] is set to [On].

Factory settings: 0

Knee Aperture Level [0 to 5]

Set the detail level of very bright parts.

This is only enabled when [Detail] is set to [On].

Factory settings: 2

Detail Gain(+) [-31 to +31]

Set the detail level of the plus direction (direction to be made brighter).

This is only enabled when [Detail] is set to [On].

Factory settings: 0

Detail Gain(-) [-31 to +31]

Set the detail level of the minus direction (direction to be made darker).

This is only enabled when [Detail] is set to [On].

Factory settings: 0

Skin Detail [Off, On]

This function smooths skin and produces a more beautiful image.

This is only enabled when [Detail] is set to [On].

This cannot be set when the [Color Setting] is [V-Log].

All of the following Skin Detail items also cannot be set when [Color Setting] is [V-Log].

Factory settings: Off

Skin Detail Effect [0 to 31]

The skin of human subjects appears smoother the larger the setting value.

This is only enabled when [Detail] is set to [On] and [Skin Detail] is set to [On].

Factory settings: 16

DownCon Detail [Off, On]

Turn on/off the contour (sharpness of images) adjustment of images down-converted from 4K to HD.

This is enabled when [Format] is the following.

- 2160/59.94p, 2160/29.97p, 2160/23.98p, 2160/24p, 2160/50p, 2160/25p

This cannot be set when the [Color Setting] is [V-Log].

All of the following DownCon Detail items also cannot be set when [Color Setting] is [V-Log].

Factory settings: On

DC. Master Detail [-31 to +31]

Adjust the contour correction level (master) for images down-converted from 4K to HD.

This is enabled when [Format] is the following.

- 2160/59.94p, 2160/29.97p, 2160/23.98p, 2160/24p, 2160/50p, 2160/25p

This is only enabled when [DownCon Detail] is set to [On].

Factory settings: -20

DC. Detail Coring [0 to 60]

Set the level of the signal (including noise) which makes the detail effect not work for images down-converted from 4K to HD.

This is enabled when [Format] is the following.

- 2160/59.94p, 2160/29.97p, 2160/23.98p, 2160/24p, 2160/50p, 2160/25p

This is only enabled when [DownCon Detail] is set to [On].

Factory settings: 15

DC. V Detail Level [-7 to +7]

Adjust the contour correction level in the vertical direction for images down-converted from 4K to HD.

This is enabled when [Format] is the following.

- 2160/59.94p, 2160/29.97p, 2160/23.98p, 2160/24p, 2160/50p, 2160/25p

This is only enabled when [DownCon Detail] is set to [On].

Factory settings: 7

DC. Detail Frequency [-2 to +2]

Set the boost frequency of detail for images down-converted from 4K to HD.

- 2: Low frequency
- to
- +2: High frequency

When a high frequency is selected, the detail effect is added to subjects with more definition.

This is enabled when [Format] is the following.

- 2160/59.94p, 2160/29.97p, 2160/23.98p, 2160/24p, 2160/50p, 2160/25p

This is only enabled when [DownCon Detail] is set to [On].

Factory settings: 0

DC. Level Depend. [-7 to +7]

The larger the setting for images down-converted from 4K to HD, the more detail of bright parts is compressed.

This is enabled when [Format] is the following.

- 2160/59.94p, 2160/29.97p, 2160/23.98p, 2160/24p, 2160/50p, 2160/25p

This is only enabled when [DownCon Detail] is set to [On].

Factory settings: 0

DC. Knee Aperture Level [0 to 5]

Set the detail level of very bright parts in images down-converted from 4K to HD.

This is enabled when [Format] is the following.

- 2160/59.94p, 2160/29.97p, 2160/23.98p, 2160/24p, 2160/50p, 2160/25p

This is only enabled when [DownCon Detail] is set to [On].

Factory settings: 2

Gamma Mode

[HD, FILMLIKE1, FILMLIKE2, FILMLIKE3, FILM REC, VIDEO REC, HLG]

Select the type of gamma curve.

HD	HD (High Definition) video gamma characteristic.
FILMLIKE1	Characteristic capable of reproducing better gradation in highlights than HD gamma.
FILMLIKE2	Characteristic capable of reproducing better gradation in highlights than [FILMLIKE1].
FILMLIKE3	Characteristic capable of reproducing better gradation in highlights than [FILMLIKE2].
FILM REC	Cinema film gamma characteristic.
VIDEO REC	Cinema video gamma characteristic.
HLG	Hybrid Log Gamma characteristic.

This cannot be set when the [Color Setting] is [V-Log].

All of the following Gamma Mode items also cannot be set when [Color Setting] is [V-Log].

Factory settings: HD

<NOTE>

- When [Gamma Mode] is changed from [HLG] to a mode other than [HLG], or when changed to [HLG], IP video transmission is temporarily stopped.

Gamma [0.30 to 0.75]

Adjust the gamma correction level.

Specifying smaller values results in a gentler gamma curve for the slope of low-brightness areas and sharper contrast.

Specifying larger values results in an expanded gradient for dark areas and produces brighter images. The gamma curve for low-brightness areas will be steeper, and contrast will be softer.

This is only enabled when [Gamma Mode] is set to other than [HLG].

Factory settings: 0.45

F-REC Dynamic Level [200%, 300%, 400%, 500%, 600%]

Set the dynamic range.

This is only enabled when [Gamma Mode] is set to [FILM REC].

Factory settings: 500%

F-REC Black STR. Level [0% to 30%]

Set the black stretch.

This is only enabled when [Gamma Mode] is set to [FILM REC].

Factory settings: 0%

V-REC Knee Slope [150%, 200%, 250%, 300%, 350%, 400%, 450%, 500%]

Set the knee slope.

This is only enabled when [Gamma Mode] is set to [VIDEO REC].

Factory settings: 150%

V-REC Knee Point [30% to 107%]

Set the knee point.

This is only enabled when [Gamma Mode] is set to [VIDEO REC].

Factory settings: 30%

Black Gamma [-8 to +8]

Set the gamma curve for dark areas.

-8 to -1	Compresses dark parts.
1 to 8	Expands dark parts.

Factory settings: 0

Black Gamma Range [1 to 3]

Set the maximum level of compression/expansion.

1	Around 20%
2	Around 30%
3	Around 40%

Factory settings: 1

DRS [Off, Low, Mid, High]

Set the DRS function which performs correction when video with high light/dark contrast is displayed.

You can select from a [Low], [Mid], or [High] effect level.

This is only enabled when [Gamma Mode] is set to other than [HLG].

Factory settings: Off

Knee Mode [Off, Auto, Manual]

Set the operating mode for gradation compression (knee).

Off	Turn the knee function off.
Auto	Enable the knee function, and set the knee point and knee slope automatically.
Manual	Enable the knee function, and set the knee point and knee slope manually.

This is only enabled when [Gamma Mode] is set to other than [HLG].

This cannot be set when the [Color Setting] is [V-Log].

All of the following Knee Mode items also cannot be set when [Color Setting] is [V-Log].

Factory settings: Auto

Auto Knee Response [1 to 8]

Set the speed of the auto knee response.

The response speed increases the lower the setting value.

This is only enabled when [Gamma Mode] is set to other than [HLG].

Factory settings: 4

Knee Point [70.0% to 107.0%]

Set the compression level (knee point) position for high-brightness video signals.

This is only enabled when [Gamma Mode] is set to other than [HLG].

This is only enabled when [Knee Mode] is set to [Manual].

Factory settings: 93.0%

Knee Slope [0 to 99]

Set the knee slope.

This is only enabled when [Gamma Mode] is set to other than [HLG].

This is only enabled when [Knee Mode] is set to [Manual].

Factory settings: 99

<NOTE>

- When [DRS] is enabled, the knee setting is disabled.

HLG Knee [Off, On]

Enable or disable the operation of the HLG knee.

This is only enabled when [Gamma Mode] is set to [HLG].

This cannot be set when the [Color Setting] is [V-Log].

All of the following HLG Knee items also cannot be set when [Color Setting] is [V-Log].

Factory settings: Off

HLG Knee Point [55% to 100%]

Set the position of the HLG knee point.

This is only enabled when [Gamma Mode] is set to [HLG].

Factory settings: 55%

HLG Knee Slope [0 to 100]

Set the slope of the HLG knee.

This is only enabled when [Gamma Mode] is set to [HLG].

Factory settings: 10

White Clip [Off, On]

Turn the white clip function off/on.

This is only enabled when [Gamma Mode] is set to other than [HLG].

This cannot be set when the [Color Setting] is [V-Log].

All of the following White Clip items also cannot be set when [Color Setting] is [V-Log].

Factory settings: On

White Clip Level [90% to 109%]

Set the white clip level.

This is only enabled when [Gamma Mode] is set to other than [HLG].

This is only enabled when [White Clip] is set to [On].

Factory settings: 109%

<NOTE>

- When [Knee Mode] is set to [Auto] and the value of [White Clip Level] is changed, the knee value will also change.

DNR [Off, Low, High]

Set the digital noise reduction level for outputting bright, clear images without noise, even at night and low-light conditions.

When [Low] or [High] is selected, noise can be eliminated.

However, image lag may increase.

Factory settings: Low

● Matrix



Matrix Type [Normal, EBU, NTSC, User]

Select the type of color matrix.
The setting is confirmed with the [Set] button.

Normal	This item is used to load the preset color matrix data and compensate for the saturation and color phase.
EBU	
NTSC	
User	On the [Matrix] screen, the [Linear Matrix] and [Color Correction] values can be adjusted by the user.

This cannot be set when the [Color Setting] is [V-Log].

Factory settings: Normal

Adaptive Matrix [Off, On]

Set Off/On the function that suppresses the linear matrix to suit the shooting conditions.

This cannot be set when the [Color Setting] is [V-Log].

Factory settings: Off

Matrix Settings

Linear Matrix

This can be set when [User] has been selected as the [Matrix Type] setting.

R-G	Adjust the color to between -63 and +63 for each axis direction.
R-B	
G-R	
G-B	
B-R	
B-G	

This cannot be set when the [Color Setting] is [V-Log].

Factory settings: (→ page 80)

Color Correction

This can be set when [User] has been selected as the [Matrix Type] setting.

Adjust the saturation and hue for each color.

This cannot be set when the [Color Setting] is [V-Log].

All of the following Color Correction items also cannot be set when [Color Setting] is [V-Log].

Saturation [-63 to +63]

Adjust the saturation for each color.

Phase [-63 to +63]

Adjust the hue for each color.

B_Mg	Color between blue and magenta
Mg	Magenta
Mg_R	Color between magenta and red
Mg_R_R	Color with a 1:3 magenta to red ratio
R	Red
R_R_YI	Color with a 3:1 red to yellow ratio
R_YI	Color between red and yellow
R_YI_YI	Color with a 1:3 red to yellow ratio
YI	Yellow
YI_YI_G	Color with a 3:1 yellow to green ratio
YI_G	Color between yellow and green
G	Green
G_Cy	Color between green and cyan
Cy	Cyan
Cy_B	Color between cyan and blue
B	Blue

Factory settings: (→ page 81)

■ Lens setting screen [Lens]

The setting is confirmed with the [Set] button.

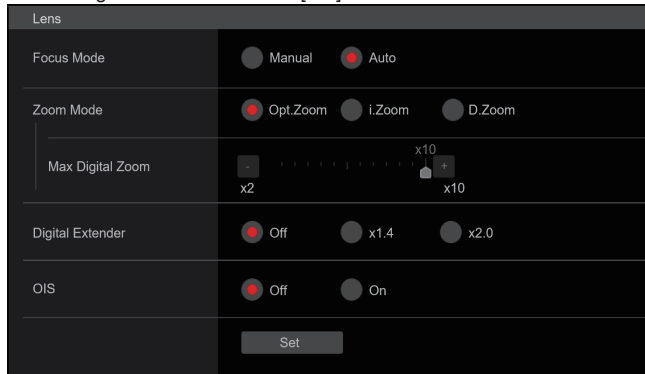

Focus Mode [Manual, Auto]

Select auto or manual mode for the focus adjustment function.

Manual	Adjust focus manually.
Auto	Always adjust focus automatically.

Factory settings: Auto

Zoom Mode [Opt.Zoom, i.Zoom, D.Zoom]

Set the maximum magnification rate for zoom.

Opt.Zoom	Use only optical zoom. Optical zoom up to 20× is possible.
i.Zoom	Enable the i.Zoom function. When this function is enabled, digital zoom is used while reducing image degradation. When [Format] in the [System] screen is 2160/59.94p, 2160/29.97p, 2160/50p, 2160/25p, 2160/24p, 2160/23.98p Up to 24× zoom is possible combining optical zoom and digital zoom. • When [Format] in the [System] screen is other than one of these, up to 32× zoom is possible combining optical zoom and digital zoom.
D.Zoom	Enable the digital zoom function. Higher digital zoom magnifications will result in coarser images.

Factory settings: Opt.Zoom

Max Digital Zoom

[x2, x3, x4, x5, x6, x7, x8, x9, x10]

Set the maximum digital zoom magnification.

This is only enabled when [Zoom Mode] is set to [D.Zoom].

Factory settings: x10

<NOTE>

- Higher digital zoom magnifications will result in coarser images.

Digital Extender [Off, x1.4, x2.0]

Make settings for the digital extender function.

Off	Turn the digital extender function off.
x1.4	The digital zoom will be fixed at 1.4×.
x2.0	The digital zoom will be fixed at 2.0×.

This is only enabled when [Zoom Mode] is set to [Opt.Zoom].

Factory settings: Off

OIS [Off, On]

Turn the optical image stabilization (OIS) function off/on.

<NOTE>

- The optical image stabilization (OIS) function's level of correction is reduced during pan/tilt operations.

Factory settings: Off

■ UHD crop setting screen [UHD Crop]

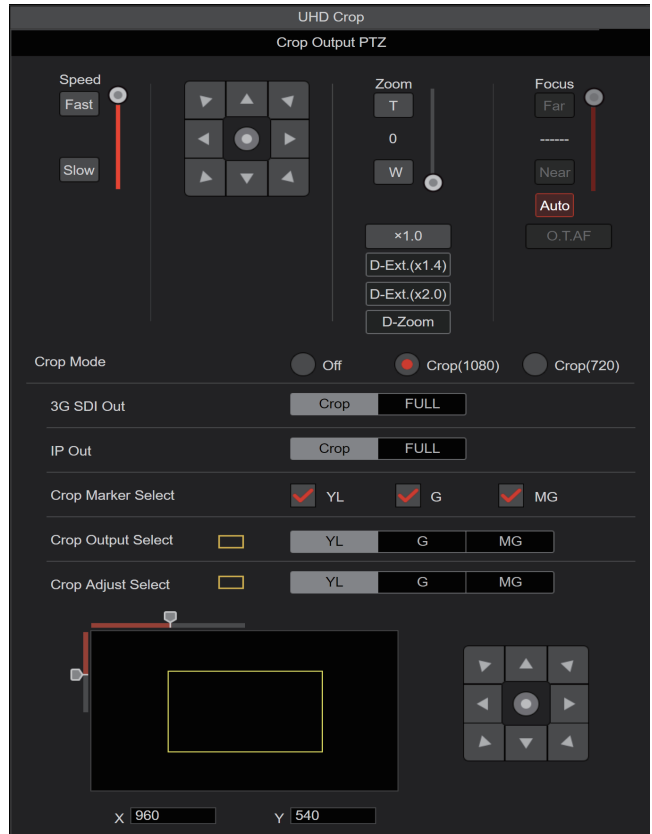

Crop Output PTZ

This is used for camera control. The same operations are possible as with the camera controller operated in the live screen [Live]. (→ page 92)

Crop Mode [Off, Crop(1080), Crop(720)]

Set the Crop function which crops UHD (3840×2160) images to 1920×1080 images or 1280×720 images.

Off	Disable the Crop function.
Crop(1080)	Crop UHD (3840×2160) images to 1920×1080 images. This is enabled only when [Format] in [System] screen is the following. 2160/59.94p, 2160/29.97p 2160/50p, 2160/25p 2160/24p, 2160/23.98p
Crop(720)	Crop UHD (3840×2160) images to 1280×720 images. This is enabled only when [Format] in [System] screen is the following. 2160/59.94p, 2160/50p

Factory settings: Off

<NOTE>

- When [Crop Mode] is changed, IP video transmission is temporarily stopped.
- When [Crop Mode] is [Crop(1080)] or [Crop(720)], the following values cannot be set in [Streaming mode].
H.264(UHD), U.265(UHD), JPEG(UHD), SRT(H.264 UHD), SRT(H.265 UHD)
(→ page 105)
- When H.264(UHD), U.265(UHD), JPEG(UHD), SRT(H.264 UHD) or SRT(H.265 UHD) is selected in [Streaming mode] and [Crop Mode] is switched to [Crop(1080)] or [Crop(720)], the [Streaming mode] setting changes to [H.264].

Web screen configurations (continued)

3G SDI Out [Crop, FULL]

IP Out [Crop, FULL]

Make the settings for Crop/FULL for images output to the 3G SDI OUT connector and IP.

Crop	Images with FHD cropped from UHD images are output. The images output in this case are those with the crop frame specified in [Crop Output Select].
FULL	FHD down-converted images are output as is without cropping UHD images.

This is only enabled when [Crop Mode] is set to [Crop(1080)] or [Crop(720)].

Factory settings: Crop

Crop Marker Select [Off, YL, G, MG, YL+G, YL+MG, G+MG, YL+G+MG]

Make the settings for the crop frame displayed for images output to the MONITOR OUT connector <MONI OUT>.

Off	Crop frame is not displayed.
YL	Only a yellow crop frame is displayed.
G	Only a green crop frame is displayed.
MG	Only a magenta crop frame is displayed.
YL+G	Yellow and green crop frames are displayed.
YL+MG	Yellow and magenta crop frames are displayed.
G+MG	Green and magenta crop frames are displayed.
YL+G+MG	Yellow, green, and magenta crop frames are displayed.

This is only enabled when [Crop Mode] is set to [Crop(1080)] or [Crop(720)].

Factory settings: YL+G+MG

Crop Output Select [YL, G, MG]

Make the settings for the crop frame for images output to the 3G SDI OUT connector and IP.

YL	Output the yellow crop frame images.
G	Output the green crop frame images.
MG	Output the magenta crop frame images.

This is only enabled when [Crop Mode] is set to [Crop(1080)] or [Crop(720)].

Factory settings: YL

<NOTE>

- The color frame specified in [Crop Output Select] will be a deeper shade when compared to other colors used for frames.

Crop Adjust Select [YL, G, MG]

Make selections for the crop frame to adjust positioning.

The position of the selected crop frame can be adjusted with the control pad displayed in the Crop Adjust Select area.

YL	Make position adjustments for the yellow crop frame.
G	Make position adjustments for the green crop frame.
MG	Make position adjustments for the magenta crop frame.

This is only enabled when [Crop Mode] is set to [Crop(1080)] or [Crop(720)].

Factory settings: YL

<NOTE>

- The color frame specified in [Crop Adjust Select] will be thicker when compared to other color frames.

X [0 to 2560]

Make settings for the position in the horizontal direction for the crop frame specified in [Crop Adjust Select].

The variable range is 0 to 1920 when [Crop Mode] is [Crop(1080)], with 0 as the left edge and 1920 as the right edge, and only even numbers can be set.

The variable range is 0 to 2560 when [Crop Mode] is [Crop(720)], with 0 as the left edge and 2560 as the right edge, and only even numbers can be set.

This is only enabled when [Crop Mode] is set to [Crop(1080)] or [Crop(720)].

Factory settings: 960

Y [0 to 1440]

Make settings for the position in the vertical direction for the crop frame specified in [Crop Adjust Select].

The variable range is 0 to 1080 when [Crop Mode] is [Crop(1080)], with 0 as the upper edge and 1080 as the lower edge.

The variable range is 0 to 1440 when [Crop Mode] is [Crop(720)], with 0 as the upper edge and 1440 as the lower edge.

This is only enabled when [Crop Mode] is set to [Crop(1080)] or [Crop(720)].

Factory settings: 540

■ Preset position screen [Preset position]

The screenshot shows the 'Preset position' web interface. At the top, it says '*setting data which changed are reflected immediately'. Below this is a 'Preset' section with a 3x3 grid of thumbnails labeled Preset001 through Preset009. To the right of the grid is a 'Limitation Setting' panel with directional buttons and status indicators for Tilt Up, Tilt Down, Pan Left, and Pan Right, all set to 'Release'. Below the grid is a numeric keypad (1-12) and a 'Home' button. Further down are 'SET' and 'DEL' buttons, and a 'JPEG Image Save' section with a dropdown menu set to 'PICT001' and a 'Save' button. The bottom half of the screen is the 'Pan/Tilt Lens Control' section, which includes sliders for Speed (Fast/Slow), Zoom (T/W), Focus (Far/Near), Iris (+/-), and Gain (0dB). Below these are checkboxes for 'Speed With Zoom Position', 'Focus Adjust With PTZ.', and 'Preset Setting'. The 'Preset Setting' section contains various options: Preset Speed Unit (Speed Table/Time), Preset Speed Table (Slow/Fast), Preset Speed (20), Preset Acceleration (Manual/Auto), Acceleration (3), Preset Scope (Mode A/B/C), Preset Digital Extender (Off/On), Preset Crop (Off/On), Preset Thumbnail Update (Off/On), Preset Name (Reset/Hold), Preset Iris (Off/On), Preset Zoom Mode (Mode A/B), and Freeze During Preset (Off/On).

● Preset

The setting is confirmed with the [SET] button.

This screenshot is identical to the one above, but the 'SET' button is highlighted in a darker shade, indicating it is the active or selected button.

	When a preset thumbnail is clicked, the camera moves to face towards a preset position that was registered beforehand. You can select Home and Preset001 to Preset100. Preset numbers are displayed in green when they have had a preset position registered in them.
Preset001 (Preset name)	Preset names are displayed. During the preset registration mode, you can select a preset name and change the display name. You can enter between 1 to 15 characters. The characters available are 0 to 9, A to Z, a to z, spaces, and underscores (_).
[1] - [12]	Switches the page of the displayed preset thumbnails.
Home [Home]	Move to home position.
SET [SET]	The unit moves to the preset registration mode. When a preset thumbnail is clicked in the preset registration mode, it is registered in the preset position specified by the current condition.
DEL [DEL]	The unit moves to the preset delete mode. When a preset thumbnail is clicked in the preset delete mode, the specified preset position settings are deleted.
JPEG Image Save [PICT001] [Save]	Acquire JPEG images (still images) and save them. PICT001 to PICT100 can be specified in the save destination so that you can update the thumbnail image for the corresponding preset number.

Web screen configurations (continued)

● Limitation Setting

This establishes the up, down, left and right limit settings of the pan-tilt head.

First, use the control pad to rotate the pan-tilt head to the position you want to set as the limit.

After the limit position has been selected, click the buttons corresponding to the following items to confirm.

The setting is cleared if the button is pressed again.

Tilt Up	Use this to save the current position as the upward limit.
Tilt Down	Use this to save the current position as the downward limit.
Pan Left	Use this to save the current position as the leftward limit.
Pan Right	Use this to save the current position as the rightward limit.

● Pan/Tilt Lens Control

This is used for camera control. The same operations are possible as with the camera controller operated in the live screen [Live].

(→ page 92)

Speed With Zoom Position [Off, On]

[Off] or [On] is set here for the function used to adjust the pan-tilt adjustment speed in conjunction with the zoom magnification.

When [On] is set, the panning and tilting operations will become slower in the zoom status.

This function has no effect during preset operations.

Factory settings: On

Focus Adjust With PTZ. [Off, On]

[Off] or [On] is set here for the function which compensates for out-of-focusing when it occurs during panning, tilting or zooming operations.

When [Off] is set, adjust the focus as required after zooming or set [Focus Mode] to [Auto].

This is only enabled when [Manual] has been selected as the [Focus Mode] setting.

Factory settings: Off

● Preset Setting

Preset Speed Unit [Speed Table, Time]

When reproducing the information such as camera direction registered in the preset memory, you can select whether to specify the playback time by speed or by time.

Speed Table	Specify the speed when playing during preset playback.
Time	Specify the time when playing during preset playback.

Factory settings: Speed Table

Preset Speed Table [Slow, Fast]

Set the preset speed table (Slow, Fast). During preset playback, presets are performed at [Preset Speed] (1 to 30) values that are based on the table set here.

This is only enabled when [Preset Speed Unit] is set to [Speed Table].

Factory settings: Fast

Preset Speed [1 to 30/1s to 99s]

When [Preset Speed Unit] is [Speed Table]: [1 to 30]

Set the pan/tilt operation speed in 30 steps when playing back the preset memory.

Factory settings: 20

<NOTE>

- When you set large [Preset Speed] values, the image may sway when the movement stops.

When [Preset Speed Unit] is [Time]: [1s to 99s]

Set the pan/tilt operation time between 1 and 99 seconds when playing back the preset memory.

Factory settings: 20s

<NOTE>

- Depending on the movement distance of pan/tilt, there may be a difference compared to the specified time.

Preset Acceleration [Manual, Auto]

Sets whether to set the acceleration and deceleration when starting or stopping preset playback.

Manual	Make settings for acceleration when starting or stopping preset playback.
Auto	Acceleration is automatic when starting or stopping preset playback.

Factory settings: Auto

<NOTE>

- This is enabled only when [Preset Speed Unit] is [Speed Table].

Acceleration [1 to 6]

Sets the acceleration speed for pan/tilt acceleration operation in 6 steps. (The acceleration speed increases as the number increases)

Factory settings: 3

<NOTE>

- This is enabled only when [Preset Speed Unit] is [Speed Table] and [Preset Acceleration] is [Manual].

Preset Scope [Mode A, Mode B, Mode C]

Selected here are the setting items to be recalled when the contents of the preset memory are regenerated.

Mode A	Pan, Tilt, Zoom (including digital zoom), Focus, Iris, Gain, white balance adjustment value
Mode B	Pan, Tilt, Zoom (including digital zoom), Focus, Iris
Mode C	Pan, Tilt, Zoom (including digital zoom), Focus

Factory settings: Mode A

Preset Digital Extender [Off, On]

Turns the preset digital extender function off/on.

When set to [On], the digital extender function configuration will be recalled when regenerating the preset memory.

When set to [Off], the digital extender function configuration will not be recalled when storing the preset memory.

Factory settings: Off

Preset Crop [Off, On]

When the preset memory is played back, set whether the reproduction of content set in the various [Crop Mode] menus is off/on.

When set to [On], the content set in the various [Crop Mode] menus is reproduced when preset memory is played back.

When set to [Off], the content set in the various [Crop Mode] menus is not reproduced when preset memory is played back, with the current values being kept.

Factory settings: Off

<NOTE>

- This is enabled only when [Format] in [System] screen is the following.
2160/59.94p, 2160/29.97p
2160/50p, 2160/25p
2160/24p, 2160/23.98p
- This is only enabled when [Crop Mode] is set to [Crop(1080)] or [Crop(720)].
- When [Crop Mode] is [Off] or [Crop(1080)] and preset memory is registered and preset playback is executed when [Crop Mode] is [Crop(720)], then, even if [Preset Crop] is [On], the content set in each menu of [Crop Mode] is not recalled.
- When [Crop Mode] is [Crop(720)] and preset memory is registered and preset playback is executed when [Crop Mode] is [Crop(1080)], then, even if [Preset Crop] is [On], the content set in each menu of [Crop Mode] is not recalled.

Preset Thumbnail Update [Off, On]

Turn off/on the function for registering the still image (thumbnail) for the images being output when a preset memory is registered. When set to [On], the still image (thumbnail) for the images being output is registered when registering a preset memory. When set to [Off], the still image (thumbnail) for the images being output is not registered when registering a preset memory, but rather the still image (thumbnail) previously registered is maintained.

Factory settings: On

<NOTE>

- When the IP for [OSD Mix] is [On], the menu screen is included in the thumbnails.
- When [Crop Mode] is [Crop(1080)] or [Crop(720)], the cropped still image is registered rather than the Full image.
- When uploading Camera(ALL) or Camera(SYSTEM) on the web screen or other access, the still image (thumbnail) that has been registered in preset memory will be erased. (→ page 151)

Preset Name [Reset, Hold]

When registering a preset memory, set whether to reset the previously registered preset name or keep it.

Reset	When registering a preset memory, reset the previously registered preset name. The preset name after resetting will be [Preset***]. (***) is a 3 digit preset number: 001 to 100)
Hold	When registering a preset memory, keep the previously registered preset name.

Factory settings: Reset

<NOTE>

- The factory default setting for the preset name is [Preset***]. (***) is a 3 digit preset number: 001 to 100)
- The registration of preset names can be done in the web browser. 0 to 9, A to Z, a to z, _ , and space

Preset Iris [Off, On]

When the preset memory is played back, set whether the reproduction of the values in the various menus related to Iris is off/on.

When set to [On], the values set in the various menus below are reproduced when preset memory is played back.

- Picture Level
- Iris Mode
- Auto Iris Speed
- Auto Iris Window
- Auto Iris Close Limit

Factory settings: Off

<NOTE>

- Its setting takes effect when [Mode A] or [Mode B] has been selected as the [Preset Scope] setting.

Preset Zoom Mode [Mode A, Mode B]

Select the zoom operation for when preset memory is recalled.

Mode A	Perform the zoom operation in line with the pan/tilt operation.
Mode B	Perform the zoom operation quicker than the pan/tilt operation.

Factory settings: Mode A

Freeze During Preset [Off, On]

Turn the function for freezing images during preset playback off/on. When this is set to [On], preset playback is performed with a still of the image immediately preceding the start of preset playback being output. The image freeze is released when preset playback is finished.

Factory settings: Off

Collaboration capability [Linkage]

Tracking data output settings screen [Tracking Data Output]

Select the output mode of the tracking data and the communication destination in the IP mode.

Up to four addresses can be specified when the IP mode is enabled.

● Setting status

Displays the output mode of tracking data and the destinations in IP mode.

Setting status		
Connection type	Serial	IP(UDP)
	Off	Off
IP out	IP address	Port
1.	192.168.0.111	1111
2.	192.168.0.112	1112
3.	192.168.0.113	1113
4.	192.168.0.114	1114

● Connection type

Connection type	
Camera ID	255 Set
Serial	<input type="radio"/> On <input checked="" type="radio"/> Off
IP(UDP)	<input type="radio"/> On <input checked="" type="radio"/> Off
Invert Pan/Tilt Axis	<input type="radio"/> On <input checked="" type="radio"/> Off

Camera ID [0x00 to 0xFF]

Sets the Camera ID for tracking data.

Factory settings: 0xFF

Serial [On, Off]

Sets the function [On] or [Off] to output the tracking data, such as Pan/Tilt/Zoom or other information from Serial Output (RS-422), synchronized with the Genlock signal. (→ page 61)

When [Serial] is set to [On], a warning message is displayed. Click the [OK] button to enable the settings.

Factory settings: Off

<NOTE>

- The serial connection of the remote controller (AW-RP150, etc.) cannot be made if [Serial] is already [On].
- In the following cases, the tracking data output may be delayed or the value may not be updated.
 - While viewing the OSD menu
 - While recalling the preset value during an ongoing preset recall
 - When executing AWB/ABB
 - When a red or a green tally signal input has been changed between Off and On
 - When deleting a preset memory
 - When an output image is flipped (turned upside down or left-right reversed)
 - After switching [Scene]
 - After switching [Iris Mode]
 - After switching [Super Gain]
 - After switching [White Balance Mode]
 - After switching each item of [Color Temperature Setting]
 - After switching [Gamma Mode]

- After switching [Matrix Type]
- After switching [Focus Mode]
- After switching [Zoom Mode]
- After switching [Max Digital Zoom]
- After switching [Digital Extender]
- After switching between [Fan1] and [Fan2]
- After switching [OSD Mix]
- After switching [Tally]
- After moving the crop frame of [Crop Mode]
- After switching [Install Position]
- After switching [Preset Speed Unit]
- When executing [Reset to the default (Except the network settings)] of [Maintenance]

IP(UDP) [On, Off]

Sets the UDP output function [On] or [Off] to output tracking data, such as Pan/Tilt/Zoom or other information from the IP output, synchronized with the Genlock signal. (→ page 62)

When [IP(UDP)] is set to [On], a warning message is displayed. Click the [OK] button to enable the settings.

Factory settings: Off

<NOTE>

- When [IP(UDP)] is [On], video transmission via IP may be delayed or the video may suffer frame loss.
We recommend setting [IP(UDP)] to [Off] to avoid the delay or frame loss due to the video transmission via IP.
- In the following cases, the tracking data output may be delayed or the value may not be updated.
 - When performing video transmission via IP (M-JPEG/H.264/H.265/RTMP/RTMPS/NDI|HX/SRT)
 - When opening the web screen (live screen [Live] or the web setting screen [Setup])
 - While viewing the OSD menu
 - While recalling the preset value during an ongoing preset recall
 - When executing AWB/ABB
 - When a red or a green tally signal input has been changed between Off and On
 - When deleting a preset memory
 - When an output image is flipped (turned upside down or left-right reversed)
 - After switching [Scene]
 - After switching [Iris Mode]
 - After switching [Super Gain]
 - After switching [White Balance Mode]
 - After switching each item of [Color Temperature Setting]
 - After switching [Gamma Mode]
 - After switching [Matrix Type]
 - After switching [Focus Mode]
 - After switching [Zoom Mode]
 - After switching [Max Digital Zoom]
 - After switching [Digital Extender]
 - After switching between [Fan1] and [Fan2]
 - After switching [OSD Mix]
 - After switching [Tally]
 - After moving the crop frame of [Crop Mode]
 - After switching [Install Position]
 - After switching [Preset Speed Unit]
 - When executing [Reset to the default (Except the network settings)] of [Maintenance]

Invert Pan/Tilt Axis [Off, On]

Sets whether to invert the Pan/Tilt data for output in the tracking data.

Off	Pan/Tilt data is not inverted.
On	Pan/Tilt data is inverted for output.

Factory settings: Off

● IP out

IP out

Output client select Client 1 Client 2 Client 3 Client 4

Client 1

IP address(IPv4)

Port (1-65535)

Client 2

IP address(IPv4)

Port (1-65535)

Client 3

IP address(IPv4)

Port (1-65535)

Client 4

IP address(IPv4)

Port (1-65535)

Output client select [Client 1 to 4]

Enable or disable up to four clients to forward the tracking data when [IP(UDP)] is [On].

Forwards the tracking data via UDP such as Pan/Tilt/Zoom or other information to the clients that are set to enable on this screen.

The setting is confirmed with the [Set] button.

Factory settings:

- Client1: Disable
- Client2: Disable
- Client3: Disable
- Client4: Disable

<NOTE>

- Disable the client that does not require the forwarding of the tracking data because the UDP packet is transmitted to the enabled client at the system frequency interval.
- When multiple clients are enabled, the timing of transmitting the UDP packet to the second and subsequent clients will always be delayed relative to the Genlock signal.
(Approximately 200 to 300 μs delay will occur for each client. The latency may be increased depending on the system status or the network environment of the unit.)

Client1 to 4

IP address(IPv4)

Sets the destination IP address to forward the tracking data such as Pan/Tilt/Zoom or other information via UDP.

The setting is confirmed with the [Set] button.

Factory settings:

- Client1: 192.168.0.111
- Client2: 192.168.0.112
- Client3: 192.168.0.113
- Client4: 192.168.0.114

<NOTE>

- The address to forward the tracking data can only be configured as IPv4.
- A multicast address cannot be specified for the destination address.

Port

Sets the destination port number to forward the tracking data such as Pan/Tilt/Zoom or other information via UDP.

The setting is confirmed with the [Set] button.

The following port numbers are used by the unit so they cannot be used.

20, 21, 23, 25, 42, 53, 67, 68, 69, 80, 110, 123, 161, 162, 443, 554, 995, 10669, 10670, 59000 to 61000

Factory settings:

Client1: 1111

Client2: 1112

Client3: 1113

Client4: 1114

<NOTE>

- You cannot set up clients having a combination of two or more IP addresses with duplicated ports.

■ P2 Cast connection setting screen [P2 Cast]

Sets whether to enable or disable connection to P2 Cast, as well as the destination server URL and the user account.

The setting is confirmed with the [Set] button.

P2 Cast	
Mode	<input checked="" type="radio"/> Off <input type="radio"/> On
Cloud URL	<input type="text"/>
User ID	<input type="text"/>
Password	<input type="text"/>
<input type="button" value="Set"/>	

Mode [On, Off]

Sets whether to connect this unit to P2 Cast via a network.

Factory settings: Off

Cloud URL

Sets the server URL of P2 Cast to be connected when [Mode] is [On].

<NOTE>

- You can set the URL with maximum 512 characters.

User ID

Sets the user ID for connection to P2 Cast when [Mode] is [On].

Password

Sets the password for connection to P2 Cast when [Mode] is [On].

Web screen configurations (continued)

User management screen [User mng.]

The users and personal computers (IP addresses) that can access the unit from personal computers and mobile terminals are registered in the User management screen [User mng.].
The User management screen [User mng.] consists of [User auth.] and [Host auth.].

User authentication screen [User auth.]

Click the [User auth.] of User management screen [User mng.].
Configure the user authentication settings for the personal computers and mobile terminals that can access the unit.
Up to 9 users can be registered.

<NOTE>

- If user authentication fails more than 8 times within a 30-second period from the same IP address (personal computer), access to the unit will be disabled for a certain period.

Setting status

The current user authentication settings and user authentication method are displayed. The currently registered account information is also displayed.

Setting status	
User auth.	Authentication
Off	Digest
	User name Access level
1.	admin Administrator

Mode

Mode.	
User auth.	<input type="radio"/> On <input checked="" type="radio"/> Off
Authentication	<input type="radio"/> Basic <input checked="" type="radio"/> Digest
<input type="button" value="Set"/>	

User auth. [On, Off]

User authentication is set to [On] or [Off] here.
The setting is confirmed with the [Set] button.
Factory settings: Off

Authentication

[Basic, Digest]

Specify the method of user authentication to use.
The setting is confirmed with the [Set] button.

Basic	Use basic authentication.
Digest	Use digest authentication.

Factory settings: Digest

Add user

Add user.	
User name	<input type="text"/>
Password	<input type="text"/>
Retype password	<input type="text"/>
Access level	<input checked="" type="radio"/> 1.Administrator <input type="radio"/> 2.Camera control
<input type="button" value="Set"/>	

User name

[1 to 32 characters]

The user name is input here.
The setting is confirmed with the [Set] button.
• The following characters can be displayed.

Numeric characters	0123456789
Alphabetical characters (upper and lower cases)	ABCDEFGHIJKLMNOPQRSTUVWXYZabcdefghijklmnopqrstuvwxyz
Symbols	!#\$%&'()*+,-./=:?@[]^_`{ }~

Password

Retype password

[4 to 32 characters]

The password is input here.
The setting is confirmed with the [Set] button.

Access level [1.Administrator, 2.Camera control]

Select the user access level.
The setting is confirmed with the [Set] button.

1.Administrator	This access level allows the user to perform all the unit's operations.
2.Camera control	This access level allows only live screen [Live] operations to be performed.

Factory settings: 1.Administrator

Delete user

Delete the user accounts registered in the unit.
You can delete selected users by clicking the [Delete] button at the right.

Delete user.		
	User name	Access level
1.	admin	Administrator
		<input type="button" value="Delete"/>

■ Host authentication screen [Host auth.]

Click the [Host auth.] of User management screen [User mng.].
Configure the host authentication settings that restrict the personal computers (IP addresses) that can access the unit.

● Setting status



Host auth.

The host authentication settings are displayed.

Host IP address

The host IP address is displayed.

Access level

The host access level is displayed.

● Mode

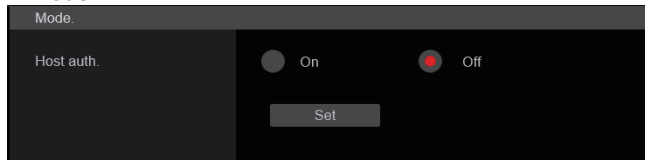

Host auth. [Off, On]

Host authentication is set to [On] or [Off] here.

The setting is confirmed with the [Set] button.

Factory settings: Off

● Add host

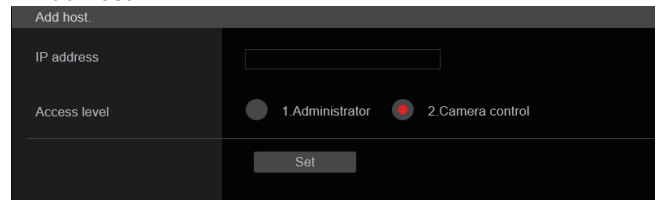

IP address

The IP address of the personal computer from which access to the camera is allowed is input here. The host name cannot be input as the IP address.

<NOTE>

- When the "IP address/subnet mask length" is input, the personal computers which are allowed to access the camera can be restricted on a subnet by subnet basis.
If, for instance, "192.168.0.1/24" has been input and the [2. Camera control] setting has been selected as the [Access level] setting, the personal computers from "192.168.0.1" to "192.168.0.254" will be able to access the camera at the [2. Camera control] access level.
- When an already registered IP address is input and the [Set] button is clicked, the host information will be overwritten.

Access level [1.Administrator, 2.Camera control]

Select the host access level.

The setting is confirmed with the [Set] button.

1.Administrator	This access level allows the user to perform all the unit's operations.
2.Camera control	This access level allows you to display images and control the unit. The unit cannot be set.

Factory settings: 2.Camera control

● Delete host

Delete the host information registered in the unit.

You can delete selected host information by clicking the [Delete] button at the right.



Network setup screen [Network]

Configure network settings in the Network setup screen.
The Network setup screen [Network] consists of [Network] and [Advanced].

Network setup screen [Network]

Click the [Network] of the Network setup screen [Network].
The setting is confirmed with the [Set] button.

The screenshot shows the Network setup screen with the following settings:

- IPv4 network**
 - DHCP: On, Off
 - IP address(IPv4): 192.168.0.10
 - Subnet mask: 255.255.255.0
 - Default gateway: 192.168.0.1
- IPv6 network**
 - Manual: On, Off
 - IP address(IPv6):
 - Default gateway:
 - DHCPv6: On, Off
- DNS**
 - Auto: Auto, Manual
 - Primary server address:
 - Secondary server address:
- Common**
 - HTTP port: 80 (1-65535)
 - Max RTP packet size: Unlimited-1500byte, Limited-1280byte
 - HTTP max segment size (MSS): Unlimited(1460byte)
 - Easy IP Setup accommodate period: 20min, Unlimited
 - Recommended network setting for internet: Execute
 - Check active network setting: Confirm

A [Set] button is located at the bottom of the screen.

IPv4 network

DHCP [On, Off]

Select the method in which the IP address is configured.

Factory settings: Off

<NOTE>

- When [DHCP] is set to [On], AW-RP150/AW-RP60's automatic configuration of IP address (AUTO IP) cannot be used.

IP address(IPv4)

Input the unit's IP address here when the DHCP function is not going to be used. Input an address that will not duplicate an existing IP address which has been set for a personal computer or another network camera.

Factory settings: 192.168.0.10

<NOTE>

- Multiple IP addresses cannot be used even when the DHCP function is used. For details on the DHCP server settings, consult your network administrator.

Subnet mask

Input the unit's subnet mask here if the DHCP function is not going to be used.

Factory settings: 255.255.255.0

Default gateway

Input the unit's default gateway if the DHCP function is not going to be used.

Factory settings: 192.168.0.1

<NOTE>

- Multiple IP addresses cannot be used for the default gateway even when the DHCP function is used. For details on the DHCP server settings, consult your network administrator.

The following information is required to configure network settings.
Consult your network administrator or Internet service provider.

- IP address
- Subnet mask
- Default gateway (when using a gateway server or router)
- HTTP port
- DNS primary and secondary server addresses (when using DNS)

Web screen configurations (continued)

● IPv6 network

Manual [On, Off]

Enable or disable manual configuration of the IPv6 address.

On	Enter the IPv6 address manually.
Off	Disable manual entry of the IPv6 address.

Factory settings: Off

IP address(IPv6)

When [Manual] is set to [On], the IPv6 address must be entered manually.

Be sure to enter an address unique from other devices.

<NOTE>

- When connecting to the manually specified IP address through a router, use an IPv6-compatible router, and enable the automatic configuration function for the IPv6 address. Be sure to configure an IPv6 address that includes the prefix information provided by the IPv6-compatible router. For details, refer to the operating instructions for the router.
- Link local address cannot be set.

Default gateway

When [Manual] is set to [On] for [IPv6 network], enter the default gateway for the unit's IPv6 network.

Factory settings: blank

<NOTE>

- It is not possible to set the default gateway when [DHCPv6] is [On].

DHCPv6 [On, Off]

Enable or disable use of the IPv6 DHCP function.

Configure the DHCP server so that the same IP address is not configured for a personal computer that does not use the DHCP function and other network cameras. For details on server settings, consult your network administrator.

On	Use the IPv6 DHCP function.
Off	Do not use the IPv6 DHCP function.

Factory settings: Off

DNS [Auto, Manual]

Set whether the DNS server address is to be acquired automatically (Auto) or to be manually input (Manual).

The DNS setting needs to be performed if [Manual] is set.

When using the DHCP function, if you set to [Auto], then the DNS server address will be acquired automatically.

Consult the system administrator regarding the settings.

Factory settings: Manual

Primary server address

Secondary server address

Enter the IPv4/IPv6 address of the DNS server.

For details on the IPv4/IPv6 address of the DNS server, consult your system administrator.

● Common (to IPv6/IPv4)

HTTP port [1 to 65535]

Port numbers are allocated separately.

The following port numbers are used by the unit so they cannot be used.

20, 21, 23, 25, 42, 53, 67, 68, 69, 80, 110, 123, 161, 162, 443, 546, 547, 554, 995, 5960 to 5985, 7960 to 8060, 10669, 10670, 11900, 59000 to 61000

Factory settings: 80

Max RTP packet size [Unlimited-1500byte, Limited-1280byte]

Specify whether to limit the size of RTP packets sent from the camera when using RTP to view camera images.

Unlimited-1500byte	Unlimited (1500 byte)
Limited-1280byte	Limited (1280 byte)

Factory settings: Unlimited-1500byte

Normally, it is recommended that the [Unlimited-1500byte] setting be used.

Select [Limited-1280byte] when the packet size of the used communication line is limited. For details on the maximum packet size of communication lines, consult your network administrator.

HTTP max segment size (MSS) [Unlimited(1460byte), Limited(1280byte), Limited(1024byte)]

Select whether to limit the maximum segment size (MSS) transmitted by a camera when viewing camera images using HTTP.

Unlimited(1460byte)	Unlimited (1460 byte)
Limited(1280byte)	Limited (1280 byte)
Limited(1024byte)	Limited (1024 byte)

Factory settings: Unlimited(1460byte)

Normally, it is recommended that the default setting be used.

Select [Limited(1024byte)]/[Limited(1280byte)] when the maximum segment size (MSS) of the used communication line is limited. For details on the maximum segment size (MSS) of communication lines, consult your network administrator.

Easy IP Setup accommodate period

[20min, Unlimited]

Select [20min] or [Unlimited] as the time for enabling the operation of the network settings from the Easy IP Setup Software.

20min	The setting operations from the Easy IP Setup Software are enabled for 20 minutes after the camera has started operating.
Unlimited	The setting operations from the Easy IP Setup Software are enabled at all times.

Factory settings: 20min

<NOTE>

- The camera screen can be opened because the camera display in the Easy IP Setup Software is constantly enabled.
- For details on the address settings of each server, consult your network administrator.
- The port forwarding function converts a global IP address to a private IP address, and includes "static IP masquerade" and "network address translation (NAT)". This function is set to the router.
- To access the camera via the Internet after connecting it to a router, it will be necessary to set an individual HTTP port No. for each network camera and to convert the address using the router's port forwarding function. For details, refer to the operating instructions for the router.

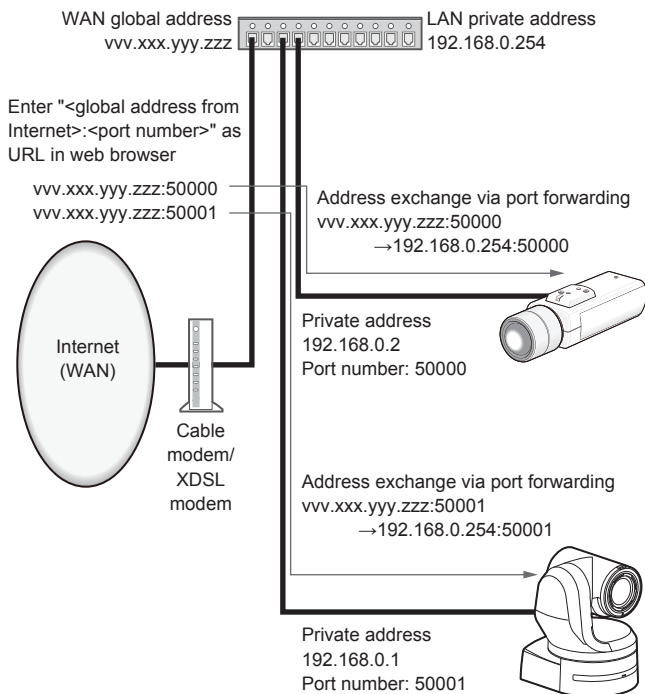

Recommended network setting for internet

Perform the recommended settings to connect the camera to the Internet.

When the [Execute] button is clicked, a dialog box will be displayed. To execute, click the [OK] button.

• [JPEG/H.264] in the Image screen [Image/Audio]

When "Streaming mode" is set to "H.264"

JPEG(1)

Image capture size: 640×360

JPEG(2)

Image capture size: 320×180

JPEG(3)

Off

H.264(1) • H.264(2) • H.264(3) [Windows I.E. 11](#)

Internet mode(Over HTTP): On

Transmission priority: Best effort

H.264(1) [Windows I.E. 11](#)

Image capture size: 1920×1080

Max bit rate(per client): Max8192kbps, Min2048kbps

H.264(2) [Windows I.E. 11](#)

Image capture size: 640×360

Max bit rate(per client): Max4096kbps, Min1024kbps

H.264(3) [Windows I.E. 11](#)

Image capture size: 320×180

Max bit rate(per client): Max4096kbps, Min512kbps

H.264(4) [Windows I.E. 11](#)

H.264 transmission: Off

When "Streaming mode" is set to "H.264(UHD)"

JPEG(1)

Image capture size: 640×360

JPEG(2)

Image capture size: 320×180

JPEG(3)

Off

H.264(1)

Internet mode(Over HTTP): Off

Max bit rate(per client): Max12800kbps

Frame rate: 30fps/25fps/24fps

H.264(2) • H.264(3) • H.264(4)

H.264 transmission: Off

When "Streaming mode" is set to "H.265(UHD)"

JPEG(1)

Image capture size: 640×360

JPEG(2)

Image capture size: 320×180

JPEG(3)

Off

H.265(1)

Max bit rate(per client): Max8192kbps

Frame rate: 30fps/25fps/24fps

When “Streaming mode” is set to “JPEG(UHD)”

JPEG(1)

Refresh interval: 1fps
Image quality: Normal

JPEG(2) • JPEG(3)

Off

H.264(1) • H.264(2) • H.264(3)

Internet mode(Over HTTP): On
Transmission priority: Best effort

H.264(1)

Image capture size: 1920×1080
Max bit rate(per client): Max8192kbps, Min2048kbps

H.264(2)

Image capture size: 640×360
Max bit rate(per client): Max4096kbps, Min1024kbps

H.264(3)

Image capture size: 320×180
Max bit rate(per client): Max4096kbps, Min512kbps

H.264(4)

H.264 transmission: Off

• [Network] in the Network setup screen [Network]

Common IPv6/v4

Max RTP packet size: Limited-1280byte
HTTP max segment size (MSS): Limited(1280byte)

Check active network setting

You can check the information about the Network settings (IPv4, IPv6, DNS) enabled on the unit.

A pop-up window is displayed when you click the [Confirm] button.

IPv4	
IP address(IPv4)	192.168.0.10
Subnet mask	255.255.255.0
Default gateway	192.168.0.1
IPv6	
IPaddress 1(IPv6)	
IPaddress 2(IPv6)	
Default gateway	
DNS	
Primary server address	
Secondary server address	
Close	

<NOTE>

- There is an IP address set manually and an IP address acquired by DHCP displayed for each of [IPaddress 1(IPv6)] and [IPaddress 2(IPv6)].

■ Advanced network setting screen [Advanced]

Click the [Advanced] in the network setup screen [Network].

Settings relating to the NTP, UPnP and HTTPS functions are performed here.

Click the links to each item to move to the respective setting page.

● Setting status

Setting status
HTTP Port number
HTTP Status
Disable
HTTPS Port number
HTTPS Status
Disable
Router global address

HTTP Port number

Displays the port number configured via UPnP port forwarding.

HTTP Status

Displays the port forwarding status.

HTTPS Port number

Displays the port number configured via UPnP port forwarding.

HTTPS Status

Displays the port forwarding status.

Router global address

Displays the global address of the router.

● NTP

Settings relating to the NTP server address and port No. are performed here.

The setting is confirmed with the [Set] button.

NTP	
Synchronization with NTP	<input type="radio"/> On <input checked="" type="radio"/> Off
NTP server address setting	Manual
NTP server address	<input type="text"/>
NTP port	<input type="text" value="123"/> (1-65535)
Time adjustment interval	<input type="text" value="1h"/>
<input type="button" value="Set"/>	

Synchronization with NTP [On, Off]

On	The time adjusted automatically through synchronization with the NTP server will be used as this unit's standard time.
Off	The time set in [Date/time] of the Basic screen [Basic] will be used as this unit's standard time.

Factory settings: Off

NTP server address setting [Auto, Manual]

Select the method to acquire the NTP server address.

Auto	Acquires the NTP server address from the DHCP server.
Manual	Sets the address by inputting the NTP server address in [NTP server address].

Factory settings: Manual

<NOTE>

- To acquire the NTP server address from the DHCP server, [DHCP] or [DHCPv6] must be set to [On] in the [Network] of the network setup screen [Network]. (→ page 132)

NTP server address

When [Manual] is selected in the [NTP server address setting], input the IP address or host name of the NTP server.

Maximum number of characters	1 to 128 characters
Characters that can be entered	Alphanumeric characters, symbols : . _ -

Factory settings: blank

<NOTE>

- To input the [NTP server address] host name, the [DNS] setting must be selected on the [Network] of the network setup screen [Network]. (→ page 133)

NTP port [1 to 65535]

Input the port No. of the NTP server.

The following port numbers are used by the unit so they cannot be used.

20, 21, 23, 25, 42, 53, 67, 68, 69, 80, 110, 161, 162, 443, 554, 995, 10669, 10670

Factory settings: 123

Time adjustment interval [1h to 24h]

Selects the interval (1 to 24 hours in 1-hour increments) for acquiring the time from the NTP server.

Factory settings: 1h

● UPnP

This unit supports UPnP (Universal Plug and Play). Using the UPnP function allows the following to be set automatically.

- Sets the router's port forwarding function. (However, a UPnP-compatible router is necessary.)

This setting is useful when accessing the camera from the Internet.

UPnP	
Auto port forwarding	<input type="radio"/> On <input checked="" type="radio"/> Off
<input type="button" value="Set"/>	

Auto port forwarding [On, Off]

Whether to use the router's port forwarding function is set by selecting [On] or [Off].

To use the automatic port forwarding function, the used router must support UPnP and the UPnP function must be enabled.

The setting is confirmed with the [Set] button.

On	Uses the router's port forwarding function.
Off	The router's port forwarding function is not used.

Factory settings: Off

<NOTE>

- The port number may be changed by automatic port forwarding. If the number is changed, the port No. of the camera registered to the personal computer or recorder must be changed.
- The UPnP function may be used when the camera is connected to the IPv4 network. IPv6 is not supported.
- To confirm that automatic port forwarding is correctly set, click the [Setting status] in the advanced network setting screen [Advanced] to confirm that the [HTTP Status] or [HTTPS Status] is set to [Enable]. (→ page 135)
If [Enable] is not displayed, refer to "Cannot access from a web browser" in the "Troubleshooting" section. (→ page 160)

● HTTPS

Using the HTTPS function enables access to the camera to be encrypted and communication safety to be improved. The setting is confirmed with the [Set] button.

See page 142 for details on the HTTPS setup method.

CRT key generate

A CRT key (SSL encryption key) is generated by HTTPS.

To generate a CRT key, click the [Execute] button to display the [CRT key generate] dialog.

For details, refer to “Generating a CRT key (SSL encryption key)” (→ page 143).

Self-signed Certificate - Generate

A self-signed security certificate is generated by HTTPS. (Self-signed Certificate)

To generate a self-signed certificate (security certificate), click the [Execute] button to display the [Self-signed Certificate - Generate] dialog and perform the operation.

For details, refer to “Generating a self-signed certificate (security certificate)” (→ page 143).

Self-signed Certificate - Information

This displays information relating to the self-signed certificate (security certificate).

When the [Confirm] button is clicked, the registered content of the generated self-signed certificate (security certificate) is displayed in the [Self-signed Certificate - Confirm] dialog.

Click the [Delete] button to delete the generated self-signed certificate (security certificate).

CA Certificate - Generate Certificate Signing Request

When using a security certificate issued by the Certificate Authority (CA) as a security certificate for HTTPS, a Certificate Signing Request (CSR) is generated for application to the Certificate Authority (CA). To generate a Certificate Signing Request (CSR), click the [Execute] button to display the [CA Certificate - Generate Certificate Signing Request] dialog and perform the operation.

For details, refer to “Generating a Certificate Signing Request (CSR)” (→ page 144).

CA Certificate - CA Certificate install

This displays information relating to server certificates (security certificates) issued by the Certificate Authority (CA), which are to be or are already installed.

In the [File Open] dialog, which is displayed by clicking the [Select] button, select the file of the server certificate (security certificate) issued by the Certificate Authority (CA) and click the [Execute] button to install the server certificate (security certificate).

If the server certificate (security certificate) is installed, its file name will be displayed.

For details, refer to “Installing a Server Certificate” (→ page 145).

CA Certificate - Information

This displays information relating to the server certificate (security certificate).

When the [Confirm] button is clicked, the registered content of the installed server certificate (security certificate) is displayed in the [Server Certificate - Confirm] dialog. If the server certificate (security certificate) is not installed, the content of the generated Certificate Signing Request (CSR) is displayed.

Click the [Delete] button to delete the installed server certificate (security certificate).

<NOTE>

- To delete an enabled server certificate (security certificate), confirm that there is a backup to the said certificate in your personal computer or recording media. A server certificate (security certificate) will be needed to reinstall it.

Connection

[HTTP, HTTPS]

This sets the method to connect to the unit.

HTTP	Only HTTP connection is possible.
HTTPS	Only HTTPS connection is possible.

Factory settings: HTTP

For details, refer to “Setting the Connection Method” (→ page 145).

<NOTE>

- When using an HTTPS connection, network connection with the AW-RP120, AW-RP50, and AK-HRP200 will be disabled.

Web screen configurations (continued)

HTTPS port [1 to 65535]

This sets the Port No. to be used with HTTPS.

The following port numbers are used by the unit so they cannot be used.

20, 21, 23, 25, 42, 53, 67, 68, 69, 80, 110, 123, 161, 162, 554, 995, 10669, 10670, 59000 to 61000

Factory settings: 443

<NOTE>

- This unit will restart if the connection method is changed.
- When using a self-signed certificate:
A warning screen is displayed when accessing the camera by HTTPS for the first time. Install the self-signed certificate (security certificate) in your personal computer in accordance with the screen instructions. (→ page 146)
- When using a server certificate:
Install the Certificate Authority (CA) root certificate or intermediate certificate in your web browser in advance.
Follow the Certificate Authority (CA) procedures to acquire and install root certificates and intermediate certificates.
- When accessing the camera by HTTPS, the image display speed and frame rate of the moving image may reduce.
- When accessing the camera by HTTPS, it may take some time for the images to be displayed.
- When accessing the camera by HTTPS, images may be disturbed and sound may be interrupted.
- The maximum number of cameras that can be connected simultaneously depends on the maximum image size and distribution format.

HTTPS mode [TLS1.0/1.1/1.2/1.3, TLS1.2, TLS1.3]

This sets the encryption protocol when accessing the camera with HTTPS.

TLS1.0/1.1/1.2/1.3	Permits connection with TLS1.0/1.1/1.2/1.3 when HTTPS is enabled.
TLS1.2	Permits connection with TLS1.2 when HTTPS is enabled.
TLS1.3	Permits connection with TLS1.3 when HTTPS is enabled.

Factory settings: TLS1.2

● RTSP

This performs settings related to the RTSP function. The RTSP function sets the RTSP transmission port and RTSP request URL used during IP image transmission.

The setting is confirmed with the [Set] button.

RTSP	
RTSP port	554 (1-65535)
RTSP request URL H.264(1)	Medialnput/h264/stream_1
RTSP request URL H.264(2)	Medialnput/h264/stream_2
RTSP request URL H.264(3)	Medialnput/h264/stream_3
RTSP request URL H.264(4)	Medialnput/h264/stream_4
RTSP request URL H.265(1)	Medialnput/h265/stream_1
Set	

RTSP port [1 to 65535]

Sets the RTSP reception port no.

The following port numbers are used by the unit so they cannot be used.

20, 21, 23, 25, 42, 53, 67, 68, 69, 80, 110, 123, 161, 162, 443, 995, 10669, 10670, 59000 to 61000

Factory settings: 554

RTSP request URL

Sets up the URL for RTSP when making IP image transmission demands to this unit.

RTSP request URL H.264(1)	RTSP URL for H.264(1) image transmission
RTSP request URL H.264(2)	RTSP URL for H.264(2) image transmission
RTSP request URL H.264(3)	RTSP URL for H.264(3) image transmission
RTSP request URL H.264(4)	RTSP URL for H.264(4) image transmission
RTSP request URL H.265(1)	RTSP URL for H.265(1) image transmission
RTSP request URL H.265(2)	RTSP URL for H.265(2) image transmission

Factory settings:

RTSP request URL H.264(1)	Medialnput/h264/stream_1
RTSP request URL H.264(2)	Medialnput/h264/stream_2
RTSP request URL H.264(3)	Medialnput/h264/stream_3
RTSP request URL H.264(4)	Medialnput/h264/stream_4
RTSP request URL H.265(1)	Medialnput/h265/stream_1
RTSP request URL H.265(2)	Medialnput/h265/stream_2

- Up to 255 characters can be entered.
- The following characters can be displayed.

Numeric characters	0123456789
Alphabetical characters (upper and lower cases)	ABCDEFGHIJKLMNOPQRSTUVWXYZ abcdefghijklmnopqrstuvwxyz
Symbols	/ - _

<NOTE>

- RTSP request URL cannot have the same URL.

Web screen configurations (continued)

● SNMP

Make SNMP functionality related settings. You can check the status of the unit by using the SNMP manager to connect. The setting is confirmed with the [Set] button.

SNMP	
SNMP	<input type="radio"/> On <input checked="" type="radio"/> Off
SNMP version	SNMPv3
User name	<input type="text"/>
Authentication	<input checked="" type="radio"/> MD5 <input type="radio"/> SHA1
Encryption method	<input checked="" type="radio"/> DES <input type="radio"/> AES
Password	<input type="text"/>
System name	<input type="text"/>
Location	<input type="text"/>
Contact	<input type="text"/>
<input type="button" value="Set"/>	

SNMP [On, Off]

Sets whether to use the SNMP function.

Factory settings: Off

User name

Sets the user name used for user authentication.

You need to specify the same user name that you set here in the SNMPv3 manager.

Maximum number of characters	0 to 32 characters
Characters that cannot be entered	Double-byte

Authentication

Sets the algorithm used for user authentication.

MD5	MD5 is used as the algorithm for user authentication.
SHA1	SHA1 is used as the algorithm for user authentication.

Factory settings: MD5

Encryption method

Sets the encryption method used for communications.

DES	DES is used as the encrypted communication method for SNMPv3.
AES	AES is used as the encrypted communication method for SNMPv3.

Factory settings: DES

Password

Sets the password used for user authentication.

You need to specify the same password that you specified here in the SNMPv3 manager.

Maximum number of characters	When [Authentication] is set to [MD5]: 8 to 16 characters When [Authentication] is set to [SHA1]: 8 to 20 characters
Characters that cannot be entered	Double-byte

System name

Enter the device name used to manage this unit using SNMP functionality.

Maximum number of characters	0 to 32 characters
Characters that cannot be entered	Double-byte

Location

Sets the location where this unit has been installed.

Maximum number of characters	0 to 32 characters
Characters that cannot be entered	Double-byte

Contact

Enter the email address or phone number of the administrator.

Maximum number of characters	0 to 255 characters
Characters that cannot be entered	Double-byte

● TSL5.0

Make settings related to TSL protocol version 5.0. Set the information required to control the tallies of this unit from a device that supports the TSL5.0 protocol with the TSL5.0 function.

The setting is confirmed with the [Set] button.

TSL5.0	
Index number	<input type="text" value="1"/>
TSL5.0 port	<input type="text" value="62000"/>
<input type="button" value="Set"/>	

Index number [1 to 65534]

By matching the INDEX set on the TSL5.0 control device and the Index number of this unit, you can control the tallies of this unit individually.

Factory settings: 1

TSL5.0 Port [1 to 65535]

Sets the port number that will receive controls via the TSL 5.0 protocol.

Factory settings: 62000

● Referrer check

By enabling Referrer check, you can confirm that the device requesting access to the camera is legitimate.

Access is refused if it is determined that the device attempting access is unauthorized.

Depending on the environment in which the unit is being used, it may not be possible to access the unit when Referrer check is enabled. If this occurs, you can access the unit by disabling Referrer check, but you will no longer be able to determine if the device attempting access is unauthorized.

Referrer check	
Referrer check	<input checked="" type="radio"/> Enable <input type="radio"/> Disable

Enable	The Referrer check function is used.
Disable	The Referrer check function is not used.

Factory settings: Enable

Web screen configurations (continued)

● mDNS

By setting an mDNS [Host name], it is possible to access this unit via <http://Host name.local>.

Maximum number of characters	63 characters
Characters that can be entered	Alphanumeric characters, symbols : -

Factory settings: panasonic-ptz

<NOTE>

- Proper operation cannot be guaranteed if there is another camera with the same settings in the same network.

● 802.1X

Makes settings for the IEEE 802.1X client.

<NOTE>

- You will require 802.1X knowledge in order to complete the settings. Consult the network administrator for details.
- It is necessary to make settings for an authentication server and Authenticator separately when building a system that uses this function. Consult the network administrator for details.
- In a system configuration where 802.1X is enabled, it is not possible to control the camera from AW-RP150 or AW-RP60.
- Before setting, go to either the [Date&Time] settings screen or the [NTP] settings screen to set the time for this unit. Proper operation may not be possible if the time has not be set correctly for the unit.
- Before setting, in the [Date&Time] settings screen, set [Memory] to [Enable].

802.1X [On, Off]

Sets whether to use the 802.1X function.

Factory settings: Off

EAP authentication method [TLS, PEAP]

Makes settings for the authentication method used for the 802.1X function.

This unit supports authentication methods using TLS or PEAP.

Factory settings: TLS

<NOTE>

- Proper operation may not be possible if it does not match the authentication method permitted by the authentication server.

TLS

Makes settings for when the TLS authentication method is used.

Client certificate type [PEM, PKCS#12]

Makes settings for the client certificate method used with TLS authentication.

This unit supports the PEM and PKCS#12 methods.

<NOTE>

- When a private key is to be used, the private key information must be included in the client certificate. Set [Private Key password usage] to [Enable] and set the correct password.
- When installing a client certificate with the PKCS#12 method, it is necessary to set [Private Key password usage] to [Enable] and to set the correct password.
- If the PKCS#12 method is selected, the PKCS#12 password and the [Private Key password] need to match.

Private Key password usage [Enable, Disable]

Sets whether to use a private key in the client certificate.

Enable	Select when a private key is to be used.
Disable	Select when a private key is not to be used.

<NOTE>

- If [Enable] is selected, the correct value needs to be set for [Private Key password].

Private Key password

Makes settings for the password set in the private key.

<NOTE>

- When installing a PKCS#12 method client certificate, enter the same password as the one set for PKCS#12.

TLS User name

Sets a user name permitted by TLS authentication.

<NOTE>

- Consult the network administrator regarding valid user names.

Client certificate install

Installs the client certificate.

<NOTE>

- The client certificate installed must be the correct one issued by the certificate authority.
- Before installing the certificate, check that the settings for [Client certificate type], [Private Key password usage], and [Private Key password] have been completed. The certificate may not be installed correctly if the above settings have not been completed.

Web screen configurations (continued)

PEAP

Makes settings for when the PEAP authentication method is used.

User name

Sets a user name permitted by PEAP authentication.

<NOTE>

- Consult the network administrator regarding valid user names.

Password

Sets the password attached to the User name in PEAP authentication.

<NOTE>

- Consult the network administrator regarding valid passwords.

CA Certificate install

Installs the CA certificate used in IEEE 802.1X authentication.

<NOTE>

- The CA certificate installed must be one issued by the correct certificate authority.

● Easy IP Setup Tool Plus

Makes settings related to Easy IP Setup Tool Plus.

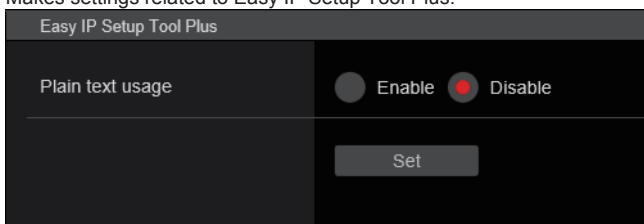

Plain text usage [Enable, Disable]

Sets whether to encrypt the communications with Easy IP Setup Tool Plus.

Factory settings: Disable

■ HTTPS settings [HTTPS]

This encrypts access to the camera and sets HTTPS to improve communication safety. Setting HTTPS is performed by following the procedures below. The setting is confirmed with the [Set] button.

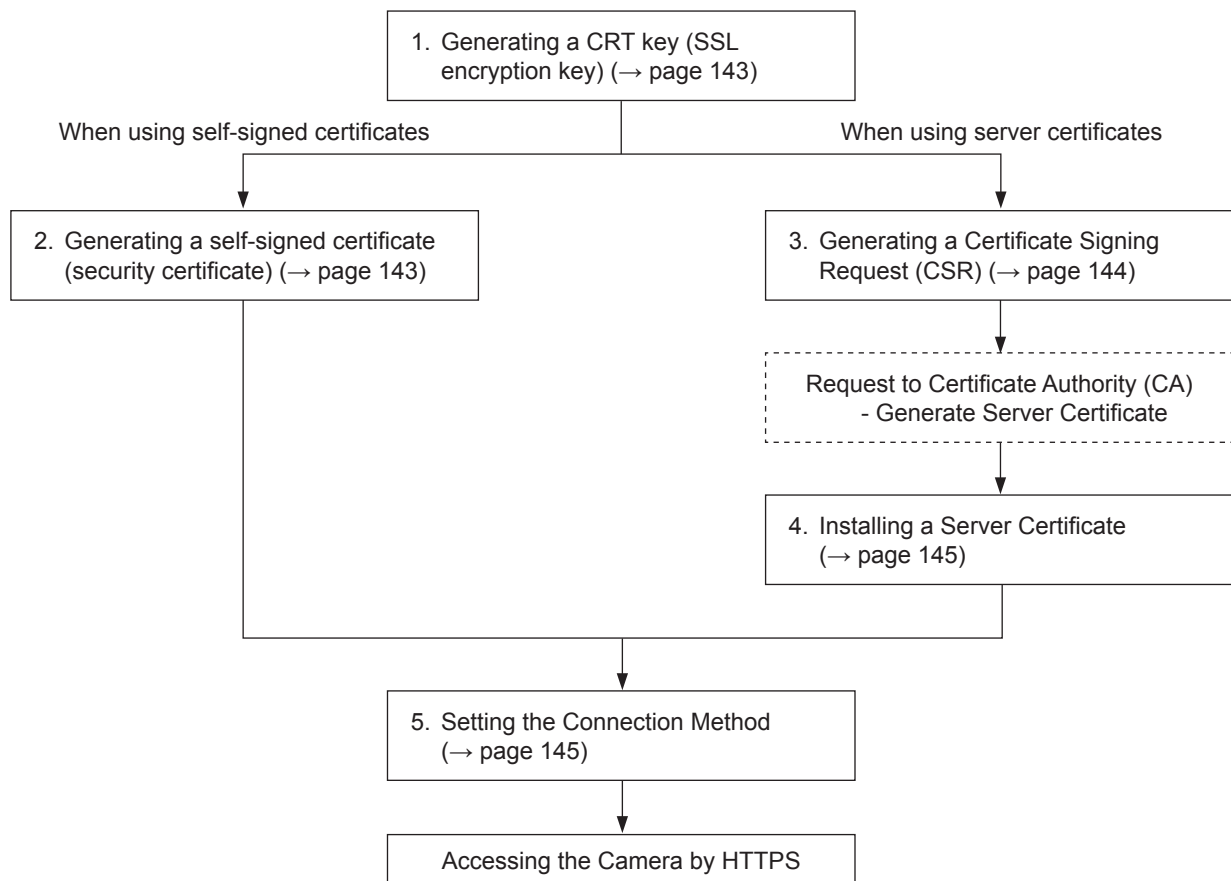
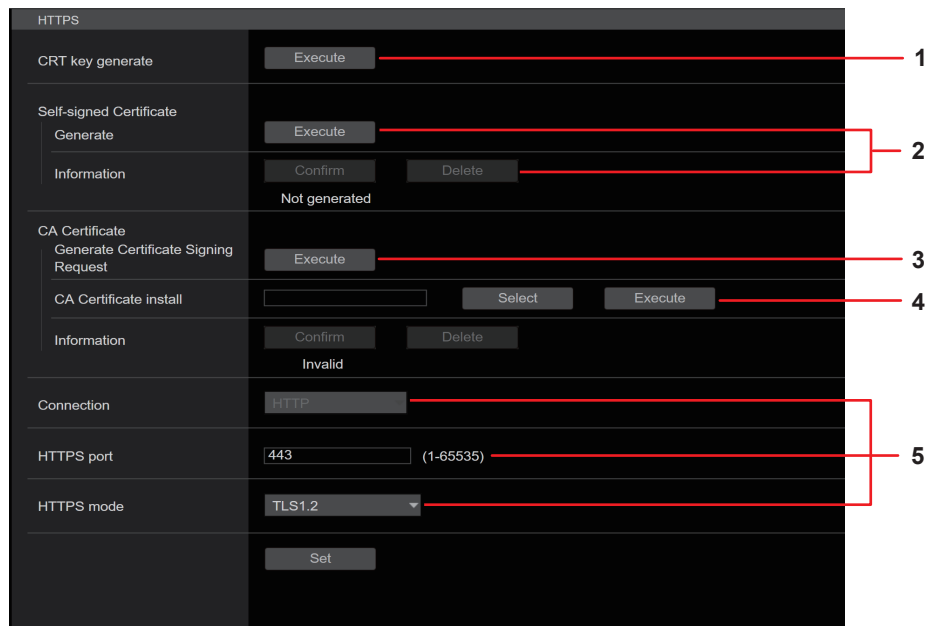

<NOTE>

- When using a server certificate, the process from applying to the Certificate Authority (CA) to issuing a server certificate must be performed between customers and the Certificate Authority (CA).
- Use either a self-signed certificate or server certificate. When simultaneously generating a self-signed certificate and installing a server certificate, this unit will prioritize the server certificate.

■ Generating a CRT key (SSL encryption key)
[CRT key generate]

<NOTE>

- A CRT key cannot be generated when self-signed certificates and server certificates are enabled.
- The size of the key that can be used by the Certificate Authority (CA) differs when using a server certificate. Confirm in advance the size of the key that can be used.
- Generating a CRT key takes about 1 minute for 1024 bit and about 2 minutes for 2048 bit. Do not operate the web browser until CRT key generation is complete. Image display and communication speed may reduce while generating a CRT key.

1. Click the [Execute] button in [CRT key generate].

The [Current CRT key] dialog is displayed.

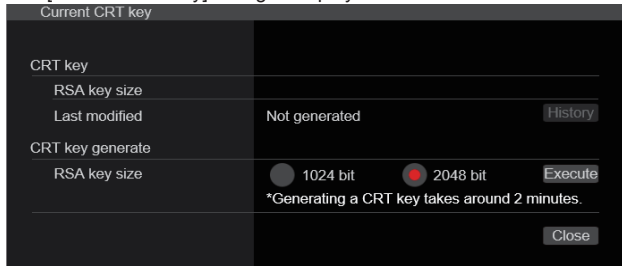

2. The size of the generated CRT key is selected from [1024bit]/[2048bit] in [CRT key generate] – [RSA key size].

<NOTE>

- When using a server certificate, the RSA key size must be in accordance with the demands of the Certificate Authority (CA) which will be applied to.

3. Click the [Execute] button.

CRT key generation starts.

When CRT key generation stops, the size of the CRT key generated by the [Current CRT key] and the date and time generation will be displayed.

<NOTE>

- Perform procedures 1 to 3 to change (update) the generated CRT key. Because the CRT key, self-signed certificate and server certificate are enabled as a set, it will be necessary to once again generate a self-signed certificate or apply for a server certificate when the CRT key is changed.
- When the CRT key is changed, previous CRT keys are historically managed one at a time. Clicking the [History] button in the [CRT key] of the [Current CRT key] dialog displays the [Previous CRT key] dialog, allowing confirmation of the key size and the date and time generation was completed.

Clicking the [Apply] button in [Previous CRT key] allows the previous CRT key to be switched to the current CRT key.

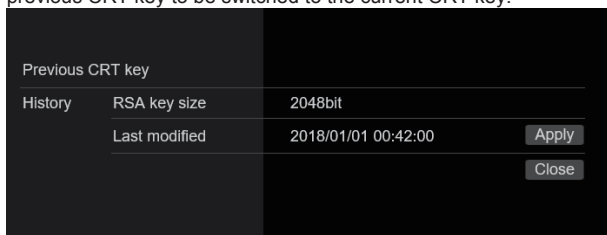

■ Generating a self-signed certificate (security certificate)
[Self-signed Certificate - Generate]

<NOTE>

- A self-signed certificate cannot be generated when a CRT key has not been generated.

1. Click the [Execute] button in [Self-signed Certificate] - [Generate].

[Self-signed Certificate - Generate] is displayed.

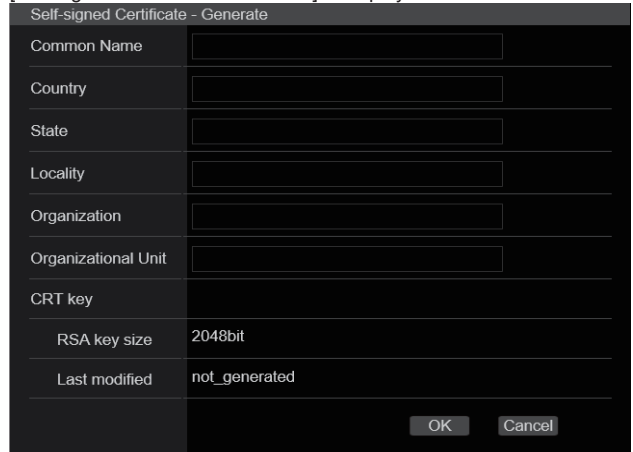

2. Input information relating to the certificate to be generated.

Items to be entered are as follows.

Item	Description	Maximum number of characters
Common Name	Inputs the camera address or host name.	64 characters
Country	Inputs the country code. (can be abbreviated)	2 characters: country code
State	Inputs the name of the state. (can be abbreviated)	128 characters
Locality	Inputs the name of the city. (can be abbreviated)	128 characters
Organization	Inputs the name of the organization. (can be abbreviated)	64 characters
Organizational Unit	Inputs the name of the organizational unit. (can be abbreviated)	64 characters
CRT key	Displays the size of the current CRT key and the date and time generation was completed.	

<NOTE>

- Characters that can be input for [Common Name], [Country], [State], [Locality], [Organization], [Organizational Unit] are 0 to 9, A to Z, a to z, and the following symbols: - , _ , + / ().
- When connecting the camera to the Internet, set the address or host name to be accessed from the Internet in [Common Name]. In this case, when accessing the camera locally, a security warning screen is displayed every time the camera is accessed even when a security certificate is installed.
- When inputting the IPv6 address in [Common Name], surround the address with [].
 e.g. [2001:db8::10]

3. Click the [OK] button after inputting the address.

A self-signed certificate is generated.

<NOTE>

- Information relating to the generated self-signed certificate is displayed in [Self-signed Certificate] - [Information]. The following is displayed depending on the status of the self-signed security certificate.

Displayed content	Description
Not generated	When the self-signed certificate is not generated
Invalid (Reason: CA Certificate installed)	When the self-signed certificate is already generated and the server certificate is already installed <ul style="list-style-type: none"> The server certificate is enabled in this case.
[Common Name] of self-signed certificate	When the self-signed certificate is already generated and enabled

- When the [Confirm] button is clicked, the registered content of the generated self-signed certificate (security certificate) is displayed in the [Self-signed Certificate - Confirm] dialog.

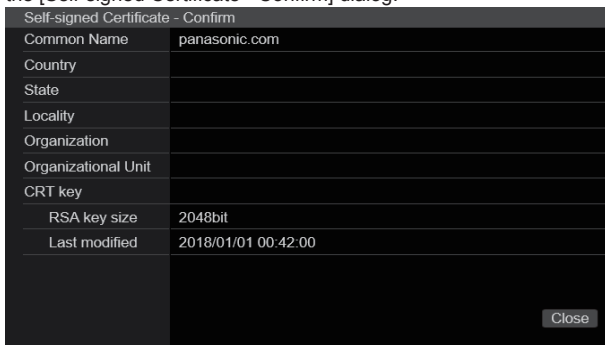

- Click the [Delete] button to delete the generated self-signed certificate (security certificate).
- When [HTTPS] is selected in [Connection], the self-signed certificate (security certificate) cannot be deleted.

■ Generating a Certificate Signing Request (CSR) [CA Certificate - Generate Certificate Signing Request]

<NOTE>

- A certificate signing request (CSR) cannot be generated if a CRT key has not been generated.
- To generate a certificate signing request (CSR), perform the following settings in advance in the web browser Internet options. Perform the following settings in the [Security] tab (accessed from [Tools] in the menu bar - [Internet Options] - [Security]).
- Register the camera as a "Trusted Site".
- In [Level Customize], go to [File Download] from [Download] and set to [Enable].
- In [Level Customize], go to [Automatically Display Dialog when Downloading File] from [Download] and set to [Enable].

1. Click the [Execute] button in [CA Certificate - Generate Certificate Signing Request].

The [CA Certificate - Generate Certificate Signing Request] dialog is displayed.



2. Input information relating to the certificate to be generated.

Items to be entered are as follows.

Item	Description	Maximum number of characters
Common Name	Inputs the camera address or host name.	64 characters
Country	Inputs the country code.	2 characters: country code
State	Inputs the name of the state.	128 characters
Locality	Inputs the name of the city.	128 characters
Organization	Inputs the name of the organization.	64 characters
Organizational Unit	Inputs the name of the organizational unit.	64 characters
CRT key	Displays the size of the current CRT key and the date and time generation was completed.	

<NOTE>

- When using a server certificate, the information to be input must be in accordance with the demands of the Certificate Authority (CA), which will be applied to.
- Characters that can be input for [Common Name], [Country], [State], [Locality], [Organization], [Organizational Unit] are 0 to 9, A to Z, a to z, and the following symbols: -, _ , + / ().

3. Click the [OK] button after inputting the address.

The [Save As] dialog is displayed.

4. In the [Save As] dialog, assign a file name to the Certificate Signing Request (CSR) and save it in personal computer.

Apply to the Certificate Authority (CA) using the saved Certificate Signing Request (CSR).

<NOTE>

- A server certificate is issued for both the generated Certificate Signing Request (CSR) and CRT key. The issued server certificate can no longer be used when generating/updating the CRT key after applying to the Certificate Authority (CA).
- The Certificate Signing Request (CSR) generated by this unit is in a PEM format.

■ Installing a Server Certificate

[CA Certificate - CA Certificate install]

<NOTE>

- A server certificate (security certificate) cannot be installed if a Certificate Signing Request (CSR) has not been generated.
- The server certificate must have been issued by the Certificate Authority (CA) in order to install it.

1. Click the [Select] button in [CA Certificate - CA Certificate install].

The [Open File] dialog is displayed.

2. Select the server certificate file and click [Open]. Then click the [Execute] button.

The server certificate is installed.

<NOTE>

- The name of the host registered to the installed server certificate is displayed in [CA Certificate] - [Information]. The following is also displayed depending on the status of the server certificate.

Displayed content	Description
Invalid	When the server certificate is not installed
[Common Name] of server certificate	When the server certificate is already installed and enabled
Expired	When the effective period of the server certificate has expired

- When the [Confirm] button is clicked, the content of the installed server certificate (security certificate) is displayed in the [CA Certificate - Confirm] dialog. (An asterisk is displayed in the [Organizational Unit] field only.)

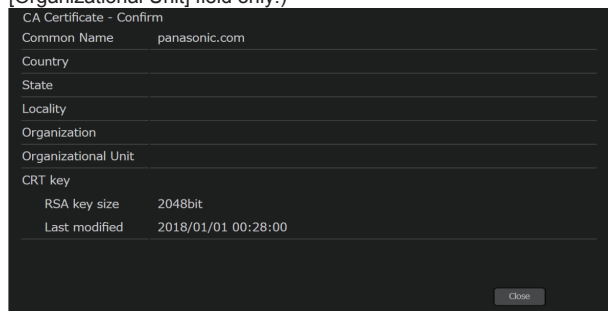

- Click the [Delete] button to delete the installed server certificate (security certificate).
- When [HTTPS] is selected in [Connection], the server certificate (security certificate) cannot be deleted.
- Perform STEP 1 to STEP 2 to update a server certificate.
- To delete an enabled server certificate (security certificate), confirm that there is a backup to the said certificate in your personal computer or recording media. A server certificate (security certificate) will be needed to reinstall it.
- The HTTPS function can no longer be used when the effective period of the server certificate has expired. In such a case, the connection method is changed to HTTP when the unit is restarted. Update the server certificate before its effective period expires.
- The effective period of the server certificate can be confirmed by double-clicking the server certificate file issued by the Certificate Authority (CA).

■ Setting the Connection Method

[Connection]

1. Set the method to access the camera in [Connection].

HTTP: Only HTTP connection is possible.

HTTPS: Only HTTPS connection is possible.

<NOTE>

- When using an HTTPS connection, network connection with the AW-RP120, AW-RP50, and AK-HRP200 will be disabled.

2. Set the Port No. to be used with HTTPS in [HTTPS port].

Port No. that can be selected: 1 to 65535

The following port numbers are used by the unit so they cannot be used.

20, 21, 23, 25, 42, 53, 67, 68, 69, 80, 110, 123, 161, 162, 554, 995, 10669, 10670, 59000 to 61000

Factory settings: 443

3. Set the encryption protocol used with HTTPS in [HTTPS mode].

TLS1.0/1.1/1.2: Connection with TLS1.0/1.1/1.2 is possible.

TLS1.2: Connection with TLS1.2 is possible.

4. Click the [Set] button.

The camera restarts and access to the camera via HTTPS is enabled.

<NOTE>

- This unit will restart if the connection method is changed.
- **Using a self-signed certificate**
A warning screen is displayed when accessing the camera by HTTPS for the first time. Install the self-signed certificate (security certificate) in your personal computer in accordance with the screen instructions. (→ page 146)
- **Using a server certificate**
Install the Certificate Authority (CA) root certificate or intermediate certificate in your web browser in advance. Follow the Certificate Authority (CA) procedures to acquire and install root certificates and intermediate certificates.
- When accessing the camera by HTTPS, the image display speed and frame rate of the moving image may reduce.
- When accessing the camera by HTTPS, it may take some time for the images to be displayed.
- When accessing the camera by HTTPS, images may be disturbed and sound may be interrupted.
- The maximum number of cameras that can be connected simultaneously depends on the maximum image size and distribution format.

■ Accessing the Camera by HTTPS

1. Launch the web browser in your personal computer.

2. Input the camera's IP address in the address bar of the web browser.

Input address: https://192.168.0.10/

<NOTE>

- When the HTTPS port No. is changed from "443", input "https:// camera IP address: Port No." in the address bar.
E.g. https://192.168.0.11:61443
- When this unit is in a local network, set a proxy server from the web browser (menu bar: [Tools] - [Internet Options]) to ensure that a proxy server is not used for a local address.

3. Press the [Enter] key.

The live screen [Live] is displayed.

The security certificate is installed when the security warning screen is displayed. (→ page 146)

When [User auth.] is set to [On], the user name and password input screen is displayed before the live screen [Live] appears.

<NOTE>

- When HTTPS is used, screen and image display may slow down and image update interval (frame rate) may also slow down.

● Install the security certificate

When using HTTPS to access the camera, the security warning screen will be displayed if the security certificate of the said camera has not been installed in your personal computer. To prevent this warning screen being displayed, the security certificate must be installed in accordance with the following procedures. If it is not installed, the security warning screen will be displayed every time the camera is accessed.

<NOTE>

- The security certificate will be installed to your personal computer based on the content set for [Common Name]. The content set for the "Host Name" must therefore match that set for the address/host name used to access the camera. If the content differs, a security warning screen will be displayed every time the camera is accessed.
- A security warning screen will be displayed if the camera address/host name is changed even when a security certificate has been installed. Reinstall the security certificate.
- When connecting the camera to the Internet, set the address or host name to be accessed from the Internet in [Common Name]. In this case, when accessing the camera locally, a security warning screen is displayed every time the camera is accessed even when a security certificate is installed.
- When the security certificate is correctly installed, an icon of the key will be displayed in the address bar of the web browser accessing the camera.

1. Accessing the Camera by HTTPS.

2. When the security warning screen is displayed, click [Continue to this website (not recommended)].

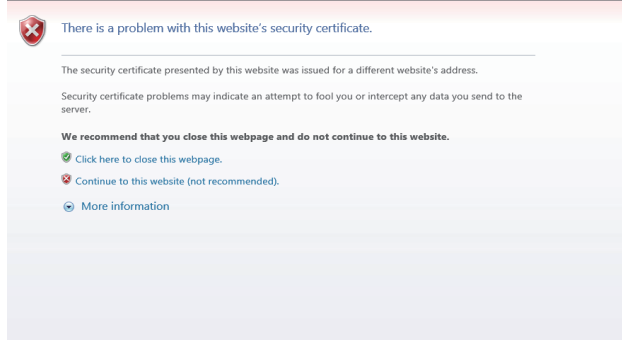

The live screen [Live] is displayed.

When the authentication screen is displayed, input the user name and password.

<NOTE>

- When the above screen is displayed after accessing a device apart from the camera or a website, there may be a security problem, so check this carefully.

3. Click [Certificate error] in the URL and then click [View certificates].

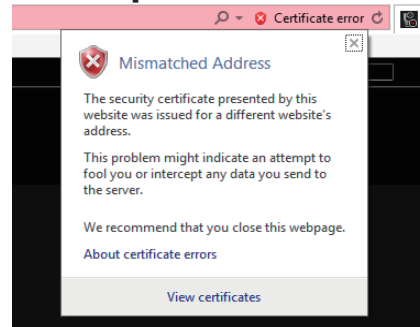

4. Click [Install Certificate...].

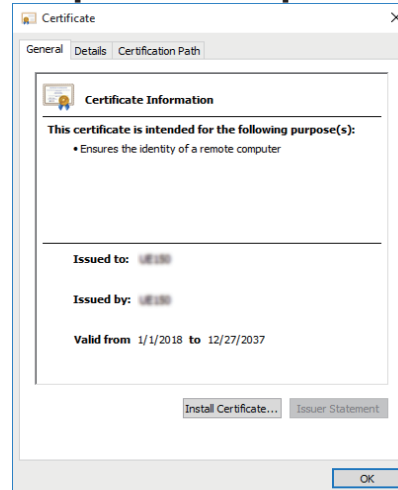

<NOTE>

- If [Install Certificate...] is not displayed, close Internet Explorer and restart it by selecting [Run as Administrator]. Right-click on [Start] - [Program] - [Internet Explorer] and click [Execute as Administrator (A)..].

5. Click [Next], which is displayed in the certificate import wizard.

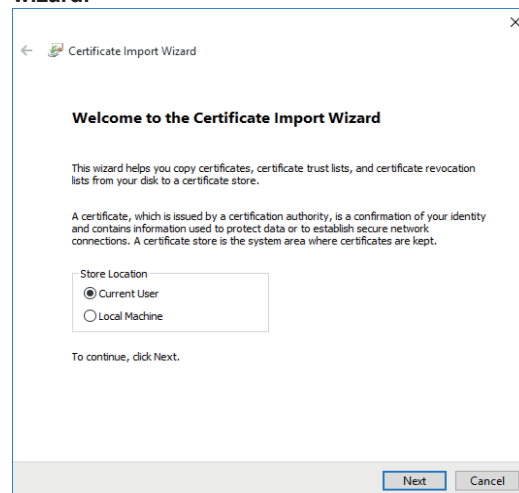

6. Select [Place all certificates in the following store] and click [Browse...].

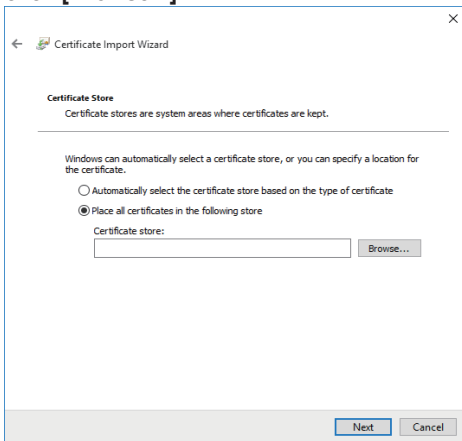

7. Select [Trusted Root Certification Authorities] and click [OK].

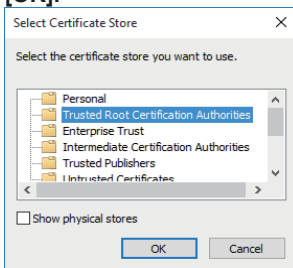

8. Click [Next].

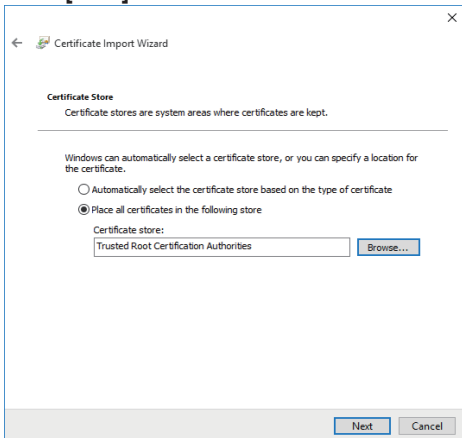

9. Click [Finish].

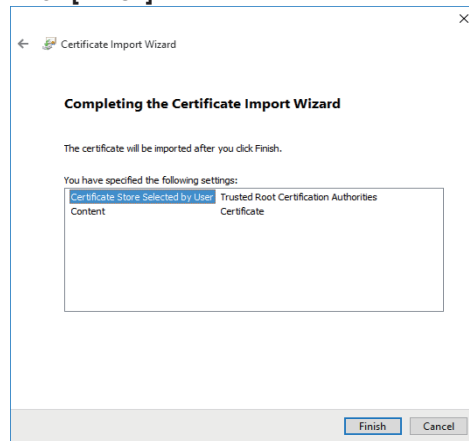

10. Click [Yes].

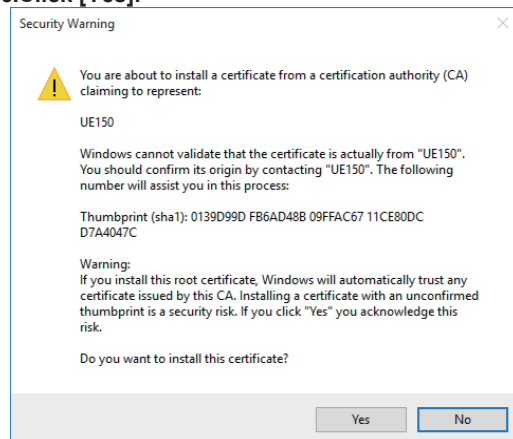

When importing is finished, the "The import was successful." screen is displayed.

11. Click [OK].

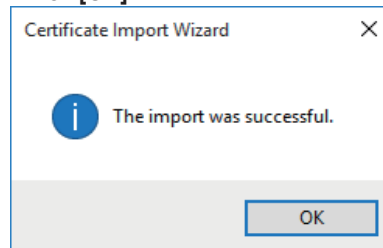

Closing the web browser after importing the certificate and reconnecting to it will stop the "Certificate error" screen being displayed.

Maintenance screen [Maintenance]

Among the various maintenance operations performed on this screen are system log checks, system version upgrading and initialization of the unit.

The Maintenance screen consists of four settings: [System log], [Product info.], [Default reset] and [Backup].

System log screen [System log]

A maximum of 1000 event logs and a maximum of 32 error logs can be stored in the unit's internal memory.

When this maximum number has been exceeded, the old logs are overwritten successively by the new logs.

The logs are cleared when the unit's power is turned off.

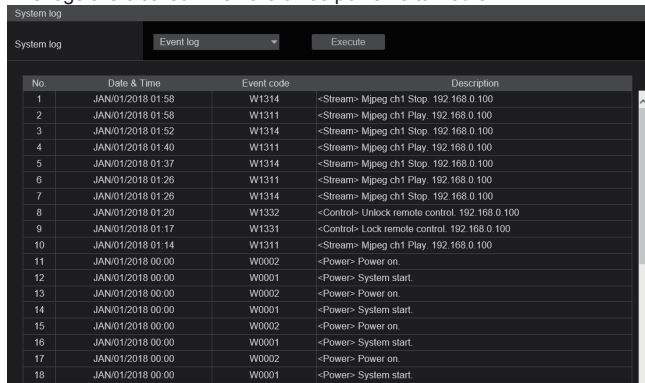

The screenshot shows a web interface for the 'System log' screen. At the top, there is a dropdown menu set to 'Event log' and an 'Execute' button. Below this is a table with the following columns: No., Date & Time, Event code, and Description. The table contains 18 rows of log entries.

No.	Date & Time	Event code	Description
1	JAN/01/2018 01:58	W1314	<Stream> Mpeg ch1 Stop. 192.168.0.100
2	JAN/01/2018 01:58	W1311	<Stream> Mpeg ch1 Play. 192.168.0.100
3	JAN/01/2018 01:52	W1314	<Stream> Mpeg ch1 Stop. 192.168.0.100
4	JAN/01/2018 01:40	W1311	<Stream> Mpeg ch1 Play. 192.168.0.100
5	JAN/01/2018 01:37	W1314	<Stream> Mpeg ch1 Stop. 192.168.0.100
6	JAN/01/2018 01:26	W1311	<Stream> Mpeg ch1 Play. 192.168.0.100
7	JAN/01/2018 01:26	W1314	<Stream> Mpeg ch1 Stop. 192.168.0.100
8	JAN/01/2018 01:20	W1332	<Control> Unlock remote control. 192.168.0.100
9	JAN/01/2018 01:17	W1331	<Control> Lock remote control. 192.168.0.100
10	JAN/01/2018 01:14	W1311	<Stream> Mpeg ch1 Play. 192.168.0.100
11	JAN/01/2018 00:00	W0002	<Power> Power on.
12	JAN/01/2018 00:00	W0001	<Power> System start.
13	JAN/01/2018 00:00	W0002	<Power> Power on.
14	JAN/01/2018 00:00	W0001	<Power> System start.
15	JAN/01/2018 00:00	W0002	<Power> Power on.
16	JAN/01/2018 00:00	W0001	<Power> System start.
17	JAN/01/2018 00:00	W0002	<Power> Power on.
18	JAN/01/2018 00:00	W0001	<Power> System start.

<NOTE>

- When the system log screen is displayed, the event log is displayed.

System log [Event log, Error log]

Switch the display between event logs and error logs.

The event log display is updated when you click the [Execute] button.

Event log	Displays the event logs.
Error log	Displays the error logs.

[Event log]

No.

Displays the log sequence numbers.

"1" indicates the latest information, and up to 1000 logs can be saved.

Date & Time

Displays the dates and times when the events occurred.

The dates and times when the events occurred are indicated in 24-hour format according to the clock of the unit.

Event code

Displays the event code numbers.

Description

Displays the event descriptions.

Display examples:

- <Power> Power on.
- <Stream> H.264 ch1 Play.
- <Stream> H.264 ch1 Stop.

[Error log]

No.

Displays the log sequence numbers.

"1" indicates the latest information, and up to 32 logs can be saved.

Operation time

Displays the dates and times when the errors occurred.

The dates and times when the errors occurred are indicated with the hour meter (0h to 99999h) of the unit.

Error code

Displays the error code numbers.

Error description

Displays the error descriptions.

Display examples:

- Motor Driver Error
- Temp Sensor Error

Product information screen [Product info.]

The versions of the unit's software can be checked on this screen. The [Model no.], [MAC address], [Serial no.], [Firmware version] and other information about the unit is displayed.

Product info.	
Model no.	AW-C41-1000
MAC address	20-C8-EB-EF-02-00
Serial no.	123456780
Firmware version	V01.02
CPU Software	Main/Network Camera Lens Servo Interface
	Ver 01.02 Ver 01.02 Ver 01.02 Ver 01.02 Ver 01.02
EEPROM	Main/Network Interface
	Ver 01.02 Ver 01.00
FPGA	COM AVIO
	Ver 01.00 Ver 01.02
Activation	
Operation time	0h
Viewer software installation counter	0
OSS license display	<input type="button" value="View"/>
Firmware file	<input type="text"/> <input type="button" value="Select"/>
	<input type="button" value="Execute"/>

Model no.

Display the unit's model number.

MAC address

Display the unit's MAC address.

Serial no.

Display the unit's serial number.

Firmware version

Display the overall system version of the unit.

CPU Software

Main/Network

Display the main/network software version.

Camera

Display the software version of the camera.

Lens

Display the software version of the lens.

Servo

Display the software version of the servo.

Interface

Display the software version of the interface.

EEPROM

Main/Network

Display the EEPROM version of the main/network.

Interface

Display the EEPROM version of the interface.

FPGA

COM

Display the FPGA version for communications.

AVIO

Display the FPGA version for image processing.

Activation

Display information on the activated function.

Operation time

Display the hours the unit has been operating.

Viewer software installation counter

The number of plug-in viewer software applications which have been installed automatically from the unit is displayed by this counter.

OSS license display

When you press the [View] button, the OSS license appears. Press the [Close] button to close the OSS license display screen.

Firmware file

Upgrade the firmware.

For details on how to upgrade, see "Upgrading the firmware (Firmware file)" (→ page 150).

● Upgrading the firmware (Firmware file)

1. Download the latest software to your personal computer.

<NOTE>

- Keep the maximum combined number of characters to be used for the name of the directory in which the software will be stored and for the name of the software which has been downloaded to less than 250 characters.

2. Click the [Select] button, and specify the downloaded software.

3. Click the [Execute] button.

The software upgrade check screen is displayed.

After upgrading the software version, be absolutely sure to delete the temporary Internet files.

<NOTE>

- An upgrade progress bar appears after you click the [Execute] button, and the process will take about 1 minute.
- Use the personal computer on the same subnet as the camera to upgrade the software version.
- Before using the version upgrading software, be absolutely sure to check the precautions to be observed, and follow the instructions.
- Use the following files specified by Panasonic Connect Co., Ltd. as the software used for version upgrading.

UPDATE.HDC

- Do not turn off the unit's power while a software version is being upgraded. (A pop-up screen will appear to indicate that the process is complete.)
- While a software version is being upgraded, do not attempt to execute any other operations until the version has been upgraded.
- Close the web browser once after performing a version upgrade.

■ Reset settings screen [Default reset]

The unit's setting data is initialized and the unit is restarted on this screen.

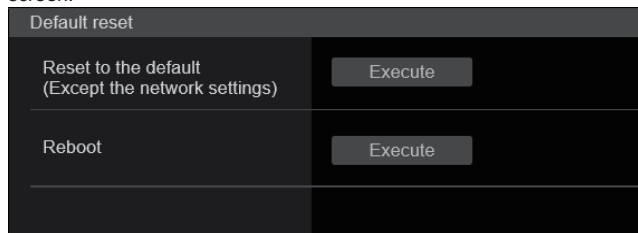

Reset to the default (Except the network settings)

When the [Execute] button is clicked, the unit's settings are returned to their defaults.

When the initialization operation is started, the unit is restarted so no operations can be undertaken for about 2 minutes.

<NOTE>

- The following setting items will not be returned to defaults.
 - [Live page - Automatic installation of viewer software]
 - [Live page - Smoother live video display on the browser(buffering)]
 - All settings under [User mng.]
 - All settings under [Network - Network]
 - [HTTPS - Connection]
 - [HTTPS - HTTPS port]
 - [HTTPS - HTTPS mode]
 - HTTPS: CRT key, server certificate
 - All settings under [UPnP]
- [AWB] and [ABB] adjustment values will not be returned to defaults.
- The settings for [Format] and [Frequency] (→ page 96) are not initialized.

Reboot

When the [Execute] button is clicked, the unit is rebooted.

After the unit has been rebooted, no operations can be undertaken for about 2 minutes as is the case when the unit's power is turned on.

■ Back up screen [Backup]

On this screen, the unit's settings can be saved to a personal computer or settings saved in a personal computer can be loaded into the unit for use.

Download

Config data type

[Camera(ALL), Camera (SCENE1) to Camera (SCENE4), Camera (SCENE ALL), Camera (SYSTEM), Network]

Specify the type of settings to save when saving the unit's configuration data on the personal computer.

Setting value	Content to be saved	Extension of saving file
Camera(ALL)	Settings for Scene1, 2, 3, 4 Settings for System, Output, Pan/Tilt, Preset (These are saved as one setting file.)	.cal
Camera (SCENE1)	Settings for Scene1	.cs1
Camera (SCENE2)	Settings for Scene2	.cs2
Camera (SCENE3)	Settings for Scene3	.cs3
Camera (SCENE4)	Settings for Scene4	.cs4
Camera (SCENE ALL)	Settings for Scene1, 2, 3, 4 (Setting files are saved for each Scene.)	.cs1 .cs2 .cs3 .cs4
Camera (SYSTEM)	Settings for System, Output, Pan/Tilt, Preset	.csy
Network	Settings of the Web screen Network settings	.nal

Download

Save the unit's settings onto the personal computer.

When the destination dialog box appears after clicking the [Download] button, specify the destination folder.

<NOTE>

- After the [Download] button is clicked, the amount of time it takes for the destination dialog box to appear is about 50 seconds for a camera settings file and about 10 seconds for a network settings file.
- Depending on the status of the unit, it may not be possible to download configuration files. In this case, the unit automatically restarts.

Upload

Config data type

[Camera(ALL), Camera (SCENE1) to Camera (SCENE4), Camera (SYSTEM), Network]

Specify the type of configuration data when reflecting the configuration data saved on a personal computer to this unit.

Setting value	File extension suitable for upload
Camera(ALL)	.cal
Camera (SCENE1)	.cs1
Camera (SCENE2)	.cs2
Camera (SCENE3)	.cs3
Camera (SCENE4)	.cs4
Camera (SYSTEM)	.csy
Network	.nal

Upload

The unit's setting files, which were saved in the personal computer by the download function, are uploaded.

Click the [Select] button to display the dialog box, and specify the saved file.

When you click the [OK] button in the message dialog box that appears after you click the [Upload] button, uploading starts.

Another message dialog box appears after uploading is complete.

When you click the [OK] button, the unit will restart automatically.

<NOTE>

- Use the files downloaded by the unit as the data to be used for uploading.
- Do not turn off the unit's power while downloading or uploading is underway.
- Do not attempt to perform any operations while downloading or uploading is underway. Instead, wait until the downloading or uploading is completed.
- It takes about 3 minutes for the upload complete dialog box to appear for camera settings files.
- When uploading Camera(ALL) or Camera(SYSTEM), the still image (thumbnail) that has been registered in preset memory will be erased. (→ page 73)

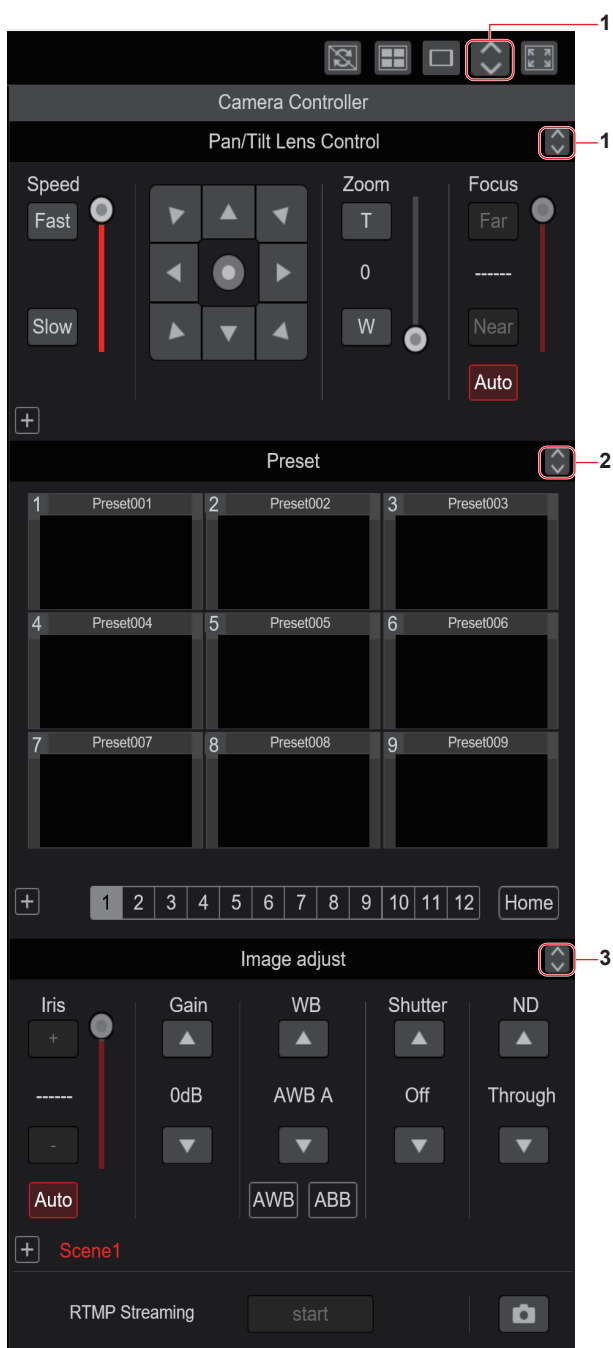

1. Button for displaying the PTZ operation screen for touch panels

The screen switches to the one for PTZ operations for touch panels when this button is pressed.

2. Button for displaying the Preset operation screen for touch panels

The screen switches to the one for Preset operations for touch panels when this button is pressed.

3. Button for displaying the Image Adjust operation screen for touch panels

The screen switches to the one for Image Adjust operations for touch panels when this button is pressed.

■ PTZ operation screen for touch panels

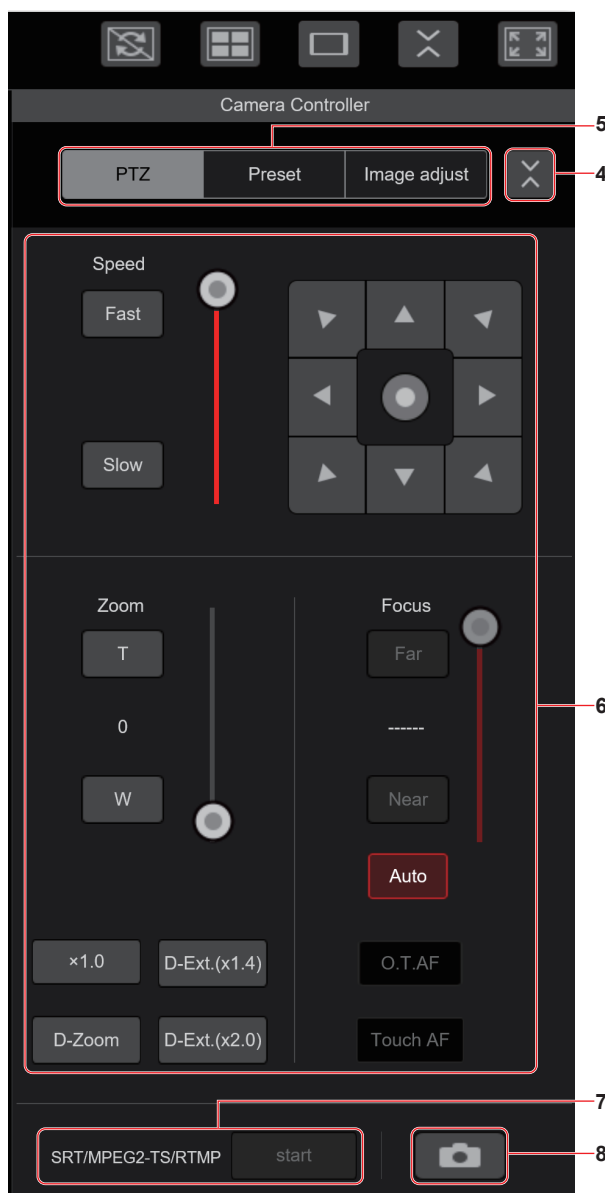

4. Button for restoring the screen from the touch panel operation screen

Press this button to return to the usual live screen.

5. Buttons for switching the touch panel operation screen

Use these to switch the [PTZ]/[Preset]/[Image adjust] operation screens for touch panels.

6. PTZ operation area for touch panels

This is the area where buttons for operating zoom, focus, pan/tilt, and speed are located that are suitable for use with touch panels.

The functionality of the operation buttons is the same as the buttons displayed in the usual live screen.

7. SRT/MPEG2-TS/RTMP operation area for touch panels

This is the area where SRT/MPEG2-TS/RTMP operation buttons are located that are suitable for use with touch panels.

The functionality of the operation buttons is the same as the buttons displayed in the usual live screen.

8. Snapshot button for touch panels

This snapshot button is suitable for use with touch panels.

The functionality of the operation buttons is the same as the buttons displayed in the usual live screen.

■ Preset operation screen for touch panels

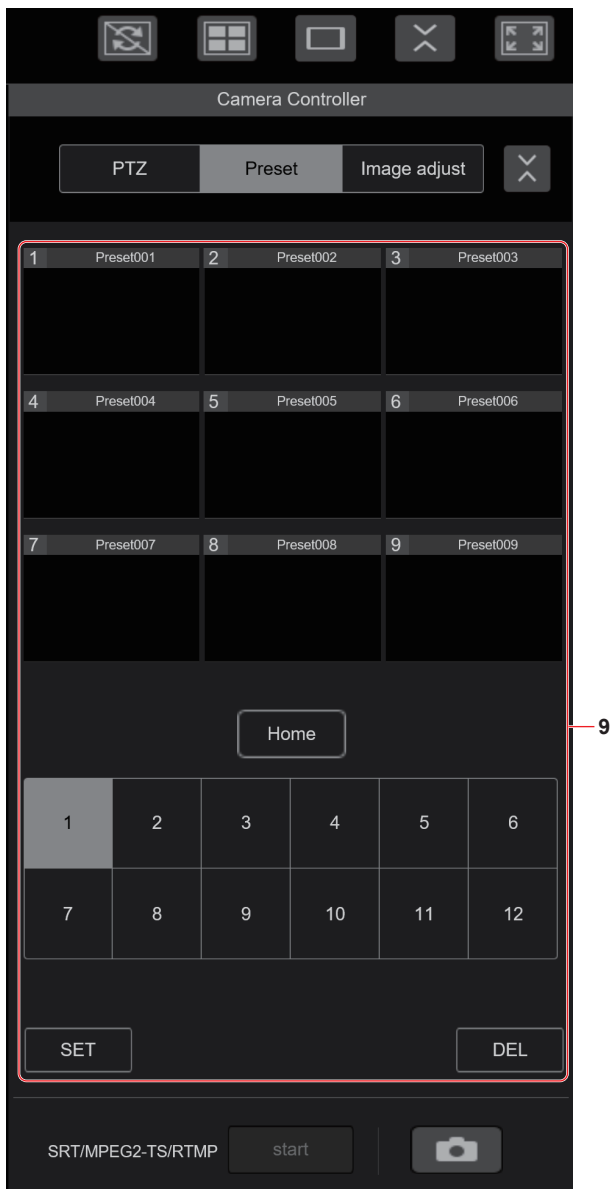

9. Preset operation area for touch panels

This is the area where buttons for preset operations are located that are suitable for use with touch panels. The functionality of the operation buttons is the same as the buttons displayed in the usual live screen.

■ Image adjust operation screen for touch panels

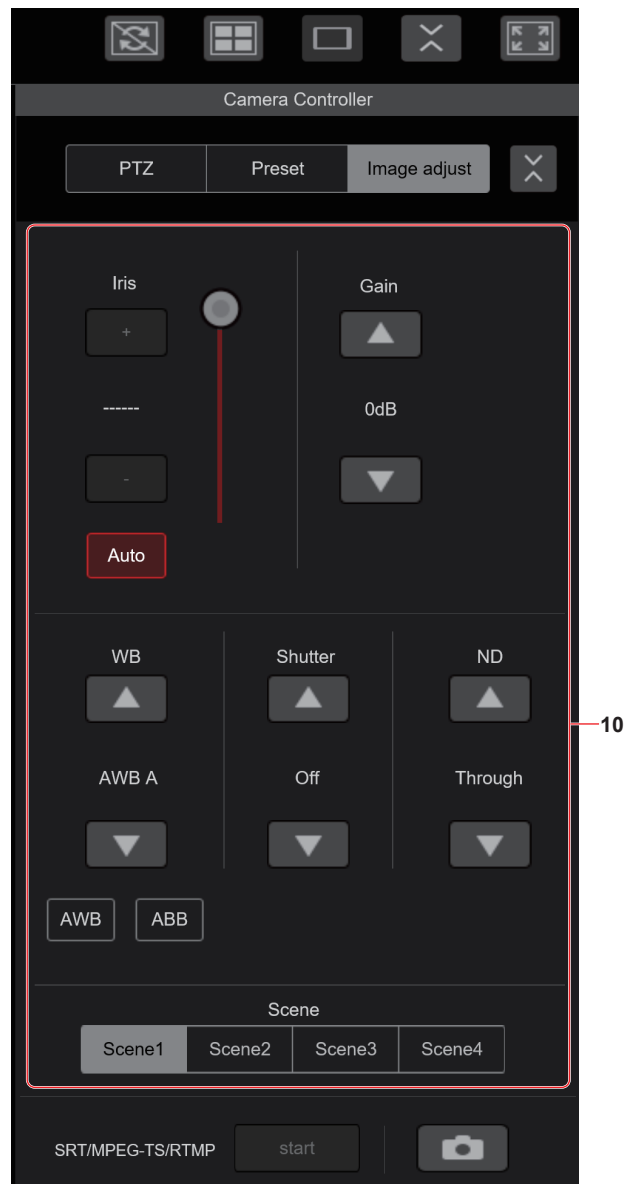

10. Image adjust operation area for touch panels

This is the area where buttons for iris, gain, balance adjustments, shutter, ND filter, and scene operations are located that are suitable for use with touch panels. The functionality of the operation buttons is the same as the buttons displayed in the usual live screen.

■ Setup operation area for touch panels

Even when the Setup screen is displayed, it is possible to display a Setup menu that is suitable for use with touch panels. The functionality of the operation buttons is the same as the buttons displayed in the usual live screen.

Displaying the web screen using a mobile terminal

It is possible to perform operations using a design suited to mobile terminals in the live screen in a web browser.

1. Access the unit from the mobile terminal.

As when accessing the unit from a personal computer, enter [http://IP address/] in the address bar of the web browser on the mobile terminal. The screen for mobile terminals is displayed automatically.



2. Switch the display.

The Full Screen mode is engaged and only video is displayed immediately after accessing the unit via a web browser on the mobile terminal. Three types of screen are available on the mobile terminal: "Camera Control", "Full Screen", and "Touch Operation Select".

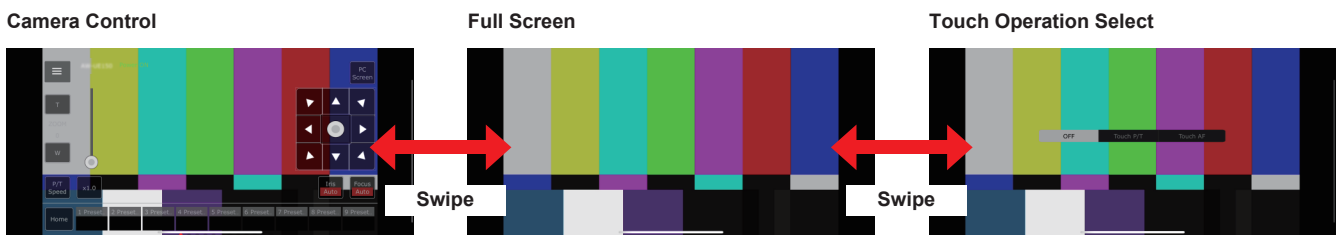

You can switch between Camera Control, Full Screen, and Touch Operation Select by swiping left or right. When Touch P/T is selected in Touch Operation Select, the middle-click function is enabled in Full Screen mode. Furthermore, when Touch AF is selected, the Touch AF function is enabled in Full Screen mode.

<NOTE>

- When the button is selected in Touch Operation Select, the screen automatically switches to Full Screen.
- Only images in the M-JPEG format are available for display on mobile terminals.

Camera control screen [Camera Control]



1. Button for displaying the operation menu for the live screen

Use this to display the operation menu for the live screen.

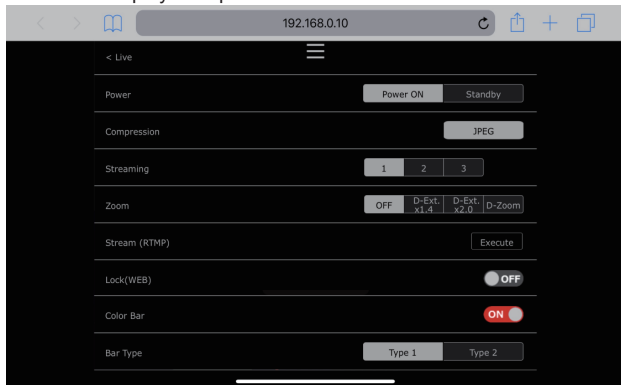

< Live

Use this to close the operation menu for the live screen.

Power

Switch Power On/Standby.

For details, refer to the [Power On] button and [Standby] button.

Compression

As only JPEG images can be displayed on mobile terminals, only the [JPEG] button is displayed.

Streaming

Switch between JPEG(1)/JPEG(2)/JPEG(3).

For details, refer to [Stream].

Zoom

Enable or disable [D-Zoom], [D-Ext. x1.4], and [D-Ext. x2.0].

For details, refer to [Zoom].

Stream (RTMP)

Streaming transmission starts to the RTMP/RTMPS server that was pre-registered.

Lock(WEB)

Enable or disable [Lock(WEB)].

For details, refer to Operation lock button [Lock].

Color Bar

Switch the color bar signal displayed or hide.

Bar Type

Switch the color bar displayed between Type1 and Type2.

2. Button for switching P/T Speed/Zoom

Use this to switch the buttons in the operation area.

When this is pressed while [P/T Speed] is being displayed, this displays the speed [Speed] button/slider in the operation area.

When this is pressed while [Zoom] is being displayed, this displays the zoom [Zoom] button/slider in the operation area.

3. P/T Speed/Zoom operation area

The [P/T Speed]/[Zoom] button/slider is displayed.

Switch between [P/T Speed] and [Zoom] with the button for switching P/T Speed/Zoom.

- The functionality of the operation buttons is the same as the buttons displayed in the usual live screen.

4. x1.0 button

Use this to adjust the zoom (magnification) to 1.0x.

5. Home button

Move to the preset home position.

6. Preset thumbnail operation area

When a preset thumbnail is clicked, the camera moves to face towards a preset position that was registered beforehand.

By swiping left in the preset thumbnail operation area, preset thumbnails that are not displayed can be displayed.

- You can select Preset1 to Preset100.

7. Button for switching the personal computer screen

This is used for switching to the live screen display for a personal computer.

Press the mobile screen display button on the live screen for personal computers to return to the mobile live screen.

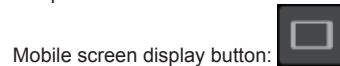

Mobile screen display button:

8. Button for switching PTZ/Focus

Use this to switch the buttons in the operation area.

When this is pressed while [PTZ] is being displayed, this displays the control pad buttons in the operation area.

When this is pressed while [Focus Manual] or [Focus Auto] is being displayed, this displays the [Focus] button/slider in the operation area.

9. PTZ/Focus operation area

The [PTZ]/[Focus] button/slider is displayed.

Switch between [PTZ] and [Focus] with the button for switching PTZ/Focus.

- The functionality of the operation buttons is the same as the buttons displayed in the usual live screen.

10. Focus (AUTO)/Iris (AUTO) button

When [PTZ] is selected with the button for switching [PTZ]/[Focus], the button for enabling or disabling Iris (Auto) is displayed.

When [Focus] is selected, the button for enabling or disabling Focus (Auto) is displayed.

Control Area

In the Control Area, operations by operation buttons are prioritized.

Scrolling of the screen as a whole can be done with touch operations outside the Control Area.

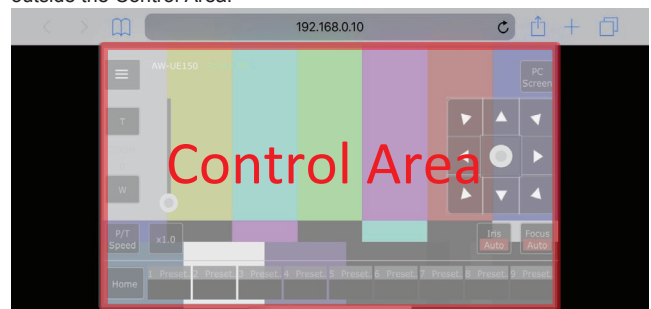

<NOTE>

- Depending on the mobile terminal you are using, it may be necessary to scroll the screen as a whole to adjust the position of the Control Area.

Limiters

This unit comes with settings (referred to as “limiters”) that restrict the panning and tilting movement ranges.

Depending on the installation location, obstacles that may come into contact with the remote camera may exist within its movement range. In such cases, setting the limiters before the obstacles will prevent contact.

The positions of four limiters — namely, the upper, lower, leftmost and right-most limits of the travel range — can be set. Once they have been set, the positions will not be lost even after the power has been turned off.

The limiters can be set or released both by the wireless remote control and controller or web setting screen [Setup]. Whatever was set or released last takes precedence. For the controller operations, refer to the Operating Instructions of the controller.

The settings of the limiters using the wireless remote control will be described here.

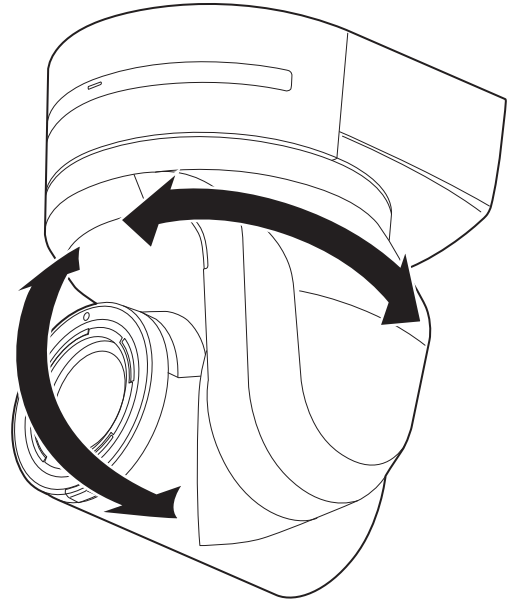

Setting/releasing the limiters

Basic limiter operations

1. Press the <MENU> button.

Tap the button (rather than pressing it). When it is pressed for 2 seconds, the camera menu will appear. If this happens, press the <MENU> button again for 2 seconds to clear the camera menu.

Then start again from step 1.

2. Press the <▲/▼/◀/▶> button for 2 seconds while holding down the <PRESET> button.

The limiter for the upper limit, lower limit, left limit or right limit is set (or released) using these direction buttons, respectively. The tally lamp will blink at this time. When a limiter is set, it blinks once; when a limiter is released, it blinks twice.

If any other button was operated between steps 1 and 2, start again from step 1.

Setting the limiters

The limiter positions can be set by following the steps below. When the position is set, the tally lamp blinks once.

1. Press one of the <CAM1> to <CAM4> button to select the unit.

• Setting the upper limit position of the movement range

Press the <▲> or <▼> button of the wireless remote control to turn the unit as far as the position which will serve as the upper limit.

Next, perform the steps in “Basic limiter operations”. (Press the <MENU> button quickly and then press the <▲> button for 2 seconds while holding down the <PRESET> button.)

• Setting the lower limit position of the movement range

Press the <▲> or <▼> button of the wireless remote control to turn the unit as far as the position which will serve as the lower limit.

Next, perform the steps in “Basic limiter operations”. (Press the <MENU> button quickly and then press the <▼> button for 2 seconds while holding down the <PRESET> button.)

• Setting the left-most limit position of the movement range

Press the <◀> or <▶> button of the wireless remote control to turn the unit as far as the position which will serve as the left-most limit.

Next, perform the steps in “Basic limiter operations”. (Press the <MENU> button quickly and then press the <◀> button for 2 seconds while holding down the <PRESET> button.)

• Setting the right-most limit position of the movement range

Press the <◀> or <▶> button of the wireless remote control to turn the unit as far as the position which will serve as the right-most limit.

Next, perform the steps in “Basic limiter operations”. (Press the <MENU> button quickly and then press the <▶> button for 2 seconds while holding down the <PRESET> button.)

Releasing the limiters

The limiter positions that are set can be released by following the steps below.

When the position is released, the tally lamp blinks twice.

1. Press one of the <CAM1> to <CAM4> button to select the unit.

2. Release the limiters by taking the steps below.

• Releasing the upper limit position of the movement range

Perform the steps in “Basic limiter operations”. (Press the <MENU> button quickly and then press the <▲> button for 2 seconds while holding down the <PRESET> button.)

• Releasing the lower limit position of the movement range

Perform the steps in “Basic limiter operations”. (Press the <MENU> button quickly and then press the <▼> button for 2 seconds while holding down the <PRESET> button.)

• Releasing the left-most limit position of the movement range

Perform the steps in “Basic limiter operations”. (Press the <MENU> button quickly and then press the <◀> button for 2 seconds while holding down the <PRESET> button.)

• Releasing the right-most limit position of the movement range

Perform the steps in “Basic limiter operations”. (Press the <MENU> button quickly and then press the <▶> button for 2 seconds while holding down the <PRESET> button.)

Resetting the limiters

To reset the limiters, the currently established settings must be released. The limiter positions that are set can be reset by following the steps below.

1. Release the settings of the limiter positions to be reset by following the steps in “Releasing the limiters”.

2. Set the limiter positions by following the steps in “Setting the limiters”.

Safe mode

Concerning the safe mode

The unit goes into the safe mode when the pan-tilt head is forcibly moved by an external force or when something impedes its rotation. Once the safe mode has been established, some or all of the operations will no longer be acknowledged to ensure safety and prevent equipment damage.

Detection of equipment trouble

When the unit has detected trouble, its functions are shut down, then the unit is restarted or the initial setting operation is performed, and the normal condition of the unit is restored after about 30 seconds.

<NOTE>

- When trouble is detected, pictures may no longer be output for a while, but they will be restored in 5 seconds to 10 seconds.

Troubleshooting

■ Operation

Symptom	Cause and solution	Reference pages
No power	<ul style="list-style-type: none"> Is the AC cable of the external DC power supply securely connected to the AC outlet? 	---
	<ul style="list-style-type: none"> If the power plug of the external DC power supply connected properly? 	---
	<ul style="list-style-type: none"> Is the LAN cable connected securely to the LAN connector for IP control <LAN LINK/ACT>? 	page 15
	<ul style="list-style-type: none"> Is the network cable for the PoE++ (IEEE 802.3bt compliant) compatible power supply device and the unit connected properly? 	Installation Instructions → "Connections" → "System example 3 (IP image transmission, PoE++)"
	<ul style="list-style-type: none"> Power may not be supplied if the total power limit is exceeded on power supply devices that allow connections to multiple PoE++ terminals. → For details, refer to the operating instructions for the PoE++ power supply device. 	---
	<ul style="list-style-type: none"> If the unit is connected to the controller, has it been connected properly? → For details, refer to the operating instructions for the controller. 	Installation Instructions → "Connections"
	<ul style="list-style-type: none"> When performing operations from a wireless remote control → Also refer to the "Cannot operate using the wireless remote control" item. 	---
Cannot operate (common to wireless remote control, controller)	<ul style="list-style-type: none"> Is the power on? → If the unit's status display lamp is off or lights up orange, it means that the unit's power is not on. 	page 31
	<ul style="list-style-type: none"> The safe mode function may have been activated. 	page 158
	<ul style="list-style-type: none"> Have the limiter functions been set? 	pages 156 to 157
	<ul style="list-style-type: none"> Has the unit you want to operate been selected properly? 	page 32
Cannot operate using the wireless remote control	<ul style="list-style-type: none"> Have the remote control's batteries run down or have the batteries been installed with their polarities reversed? → If the status display lamp does not blink even when the wireless remote control is operated near the wireless remote control signal light-sensing area, it means that the batteries have run down. Replace the batteries. 	---
	<ul style="list-style-type: none"> Have the IR ID switches been set correctly? 	page 17, page 27
	<ul style="list-style-type: none"> Is there a fluorescent light or plasma monitor near the unit and, if so, is the wireless remote control signal light-sensing area exposed to its light? 	page 14
Cannot operate using the controller	<ul style="list-style-type: none"> Is the unit connected to the controller properly? → For details, refer to the operating instructions for the controller. 	Installation Instructions → "Connections"
	<ul style="list-style-type: none"> It may be necessary to upgrade the version of the controller so that the controller will support the unit. → For details on upgrading, visit the support page on the following website. https://pro-av.panasonic.net/ 	---
The unit turns in the opposite direction to the one operated	<ul style="list-style-type: none"> Has the stand-alone (Desktop) installation setting been selected correctly? 	page 71, page 102
	<ul style="list-style-type: none"> The reversal setting may have been established at the controller if the unit is connected to the controller. → For details, refer to the operating instructions for the controller. 	---

Troubleshooting (continued)

Symptom	Cause and solution	Reference pages
Cannot access from a web browser	<ul style="list-style-type: none"> • Has a LAN cable of category 5e or above been connected to the LAN connector for IP control <LAN LINK/ACT>? 	Installation Instructions → "Connections"
	<ul style="list-style-type: none"> • Is the [LINK] LED of the LAN connector for IP control lit? → If it is not lit, it means that something is wrong with the connection to the LAN or that the network at the connection destination is not working properly. Check the LAN cable for defective contacts, and check the wiring. 	page 15
	<ul style="list-style-type: none"> • Is the power on? → If the unit's status display lamp is off or lights up orange, it means that the unit's power is not on. 	page 31
	<ul style="list-style-type: none"> • Has a valid IP address been set in the unit? 	page 131
	<ul style="list-style-type: none"> • Has the wrong IP address been accessed? → Check the connections by following the steps below. For Windows: Using the Windows command prompt, execute > ping [IP address which has been set in the camera] A reply returned from the unit signifies that there are no problems in operation. If a reply is not received, try following operation: • Reboot the unit, and within 20 minutes change the IP address using the Easy IP Setup Software. For Mac: Using the macOS terminal, execute > ping -c 10 [IP address which has been set in the camera] A reply returned from the unit signifies that there are no problems in operation. If a reply is not received, try following operation: • Reboot the unit, and within 20 minutes change the IP address using the Easy IP Setup Software. 	---
	<ul style="list-style-type: none"> • Are you accessing via "http://" while the HTTPS function is enabled? → Perform access via "https://" when using the HTTPS function. Entry of the port number is also required. 	page 145
	<ul style="list-style-type: none"> • Is the same IP address setting being used by another unit? → Check out the IP addresses of the unit, access devices (personal computer, controller, etc.) and any other cameras. 	page 75
	<ul style="list-style-type: none"> • Does the subnet mask setting match the network subnet of the connection destination? → Check out the subnet mask settings of the unit and access devices, and then consult with the network administrator. 	page 75
	<ul style="list-style-type: none"> • Has the "Use a proxy server" setting been selected by the web browser? (When the unit and the personal computer are connected to the same subnet) → If a proxy server has been set using the [proxy setting] of the web browser, it is recommended that a "Don't use proxy" address be selected as the unit's IP address setting. 	---
<ul style="list-style-type: none"> • Has the wrong default gateway been set for the unit? (When the unit and personal computer are connected to different subnets) → Check out the default gateway that has been set for the unit, and then consult with the network administrator. 	page 75	

Troubleshooting (continued)

Symptom	Cause and solution	Reference pages
<p>The settings on the web setting screen [Setup] are not updated or displayed properly</p>	<p>For Windows:</p> <ul style="list-style-type: none"> • Press the [F5] key on the keyboard of the personal computer to request that the settings be acquired. <p>For Mac:</p> <ul style="list-style-type: none"> • Press the [Command] + [R] key on the personal computer's keyboard to request that the settings be acquired. 	<p>---</p>
	<ul style="list-style-type: none"> • Perform the following to delete the temporary Internet files. <p>For Windows:</p> <ol style="list-style-type: none"> ① Select [Tools] - [Internet Options] in Internet Explorer. ② Click the [General] tab, and click the [Delete] button under [Browsing history]. ③ In the [Delete Browsing History] dialog box, select the [Temporary Internet files and website files] checkbox, and then click [Delete]. ④ Click the [OK] button. <p>For Mac:</p> <ol style="list-style-type: none"> ① Select [Develop] - [Empty Cache] in Safari. ② Click [Empty] in the [Are you sure you want to empty the cache?] pop-up screen. 	<p>---</p>
	<p>For Windows:</p> <ul style="list-style-type: none"> • If [Check for newer versions of stored pages] is not set to [Every time I visit the webpage] in the temporary Internet file settings, the web setup screen may not appear. <p>→ Perform the following.</p> <ol style="list-style-type: none"> ① Select [Tools] - [Internet Options] in Internet Explorer. ② Click the [General] tab, and click the [Settings] button under [Browsing history]. ③ In the [Temporary Internet Files] dialog box, select the [Every time I visit the webpage] option under [Check for newer versions of stored pages]. ④ Click the [OK] button. 	<p>---</p>
	<ul style="list-style-type: none"> • The unit's ports may be filtered by the firewall or other function of the anti-virus software. <p>→ Change the HTTP port number of the unit to a port number that will not be filtered.</p>	<p>---</p>
<p>It is not possible to download the setting files</p>	<p>For Windows:</p> <ul style="list-style-type: none"> • Has the file download function been disabled? <p>→ Perform the following.</p> <ol style="list-style-type: none"> ① Select [Tools] - [Internet Options] in Internet Explorer. ② Click the [Security] tab, and click the [Custom level] button under [Security level for this zone]. ③ In the [Security Settings] dialog box, select the [Enable] option for [File download]. ④ Click the [OK] button. ⑤ Click the [OK] button. 	<p>---</p>
<p>The tally lamps do not light</p>	<ul style="list-style-type: none"> • Is the [Tally] setting set to [Disable]? <p>→ If [Tally] is set to [Disable], the unit's tally lamp does not light. Change the setting to [Enable].</p>	<p>page 68, page 102</p>

Troubleshooting (continued)

Symptom	Cause and solution	Reference pages
Status display lamp does not light	<ul style="list-style-type: none"> • Is the [Status Lamp] setting set to [Disable]? → If [Status Lamp] is set to [Disable], the status display lamp does not light when this unit is working properly. Change the setting to [Enable]. 	page 68, page 102
The authentication screen appears repeatedly	<ul style="list-style-type: none"> • Has the user name or password been changed? → If you change the user name and password of the user currently logged in from a separate web browser while the unit is being accessed, the authentication screen appears each time the screen display is changed. Close the web browser, and initiate access to the unit again. 	page 130
	<ul style="list-style-type: none"> • Has the method for user authentication been changed? → If you change the [User auth.] - [Authentication] setting, close the web browser and initiate access again. 	page 130
Screens displays take a while to appear	<ul style="list-style-type: none"> • Is access being performed in HTTPS mode? Screen displays may take a while to appear in HTTPS mode due to signal processing. 	---
	<ul style="list-style-type: none"> • Is the unit on the same local network and being accessed via proxy? → Configure the web browser settings so that access is not performed via proxy. 	---
	<ul style="list-style-type: none"> • Are multiple users accessing the unit's IP images at the same time? → When multiple users access the unit's IP images at the same time, images may take some time to appear, and the frame rate of the IP images may drop. 	---

■ Video

Symptom	Cause and solution	Reference pages
No pictures are displayed or the pictures are disturbed	<ul style="list-style-type: none"> • Has the unit been connected properly to the other connected devices? 	Installation Instructions → "Connections"
	<ul style="list-style-type: none"> • If the system is configured in such a way that the picture is also switched when the unit to be operated is selected, has the correct unit been selected? 	page 32
	<ul style="list-style-type: none"> • Has the image signal setting been selected correctly? 	page 57, page 96
	<ul style="list-style-type: none"> • Are external sync signals that are supported by the video signal format which has been set being input? 	page 17
The picture is flipped vertically	<ul style="list-style-type: none"> • Has the stand-alone (Desktop) installation setting been selected correctly? 	page 71, page 102
Multiple color bands (color bars) are displayed	<ul style="list-style-type: none"> • Switch to the camera picture. 	page 35
The menu screen is displayed	<ul style="list-style-type: none"> • Exit the camera menu. 	page 44
It is difficult to view the menu screens	<ul style="list-style-type: none"> • Depending on the HDMI monitor you are using, you may experience one or more of the symptoms described below. These symptoms are especially noticeable when any of the SD formats is used: This is normal and not indicative of any trouble. <ul style="list-style-type: none"> • The resolution of the characters in the camera menu displays changes as the background image changes. • Depending on the edge enhancement setting established for the monitor, white lines appear in front of the black shadows of the camera menus. • Depending on the edge enhancement setting established for the monitor, the background colors may be superimposed onto the white parts of the camera menus. 	---
No auto focusing	<ul style="list-style-type: none"> • Is the focus set to manual? → Auto focusing is initiated as soon as the focus is set to auto. 	page 35
	<ul style="list-style-type: none"> • In some situations, it may be hard to focus at the auto setting. → In cases like this, select the manual setting, and focus manually. 	page 37
The subject is not brought into focus during zooming when the manual setting is used for the focus	<ul style="list-style-type: none"> • Was the focus adjusted at the Tele end? → First adjust the focus at the Tele end where the focusing accuracy is higher, and then proceed with the zooming. 	---
	<ul style="list-style-type: none"> • Under some operating conditions, it may be hard to bring subjects into focus. → In such cases, use the focus at the auto setting. 	page 35
Focusing is not possible in night mode	<ul style="list-style-type: none"> • Are you shooting with visible light? → The focus position is different due to the difference in refractive index between visible light and infrared light. Wavelengths near 850 nm are assumed for infrared light in night mode on this unit. Perform manual adjustment if necessary. 	page 37
1080/29.97PsF images appear jerky	<ul style="list-style-type: none"> • This is normal operation. → In the PsF (Progressive segmented Frame) format, an identical image is captured to fields 1 and 2 in order to output the same image as progressive. Therefore, the image will appear slightly jerky. 	---
1080/25PsF images appear jerky	<ul style="list-style-type: none"> • This is normal operation. → In the PsF (Progressive segmented Frame) format, an identical image is captured to fields 1 and 2 in order to output the same image as progressive. Therefore, the image will appear slightly jerky. 	---

Troubleshooting (continued)

Symptom	Cause and solution	Reference pages
Something is wrong with the coloring of the pictures	<ul style="list-style-type: none"> • Activate the ATW (Auto tracking white adjustment) function. 	page 40
	<ul style="list-style-type: none"> • In some situations, the proper colors may not be reproduced using the ATW function. → In cases like this, proceed with the white balance adjustment. 	pages 39 to 40
The pictures are too light or too dark	<ul style="list-style-type: none"> • Either select the auto setting for the iris or select the manual setting and adjust the iris manually. 	page 37
	<ul style="list-style-type: none"> • The pictures may be dark if the analog video signal cables are too long because this will cause signal attenuation. 	---
Images are in black and white	<ul style="list-style-type: none"> • Is the unit in night mode? → In night mode, output will be in black and white. 	page 48, page 116
Auto white balance adjustment (AWB) is not possible	<ul style="list-style-type: none"> • Is the unit in night mode? → Auto white balance adjustment (AWB) is not possible in night mode. 	page 48, page 116
The screen is too bright in night mode	<ul style="list-style-type: none"> • The aperture is set to open in night mode to prevent video voyeurism. Adjust the brightness at the light source. 	page 37
The iris does not operate in night mode		
The subjects appear distorted	<ul style="list-style-type: none"> • Since this camera uses an MOS imaging device, the pickup timing differs slightly at the top left and bottom right of the screen. This means that if a subject moves quickly across the front of the camera, it may appear slightly distorted. This is not a malfunction. 	---
When the flash is fired during shooting, only the top or bottom of the screen becomes lighter	<ul style="list-style-type: none"> • With a MOS imaging sensor, the pickup timing differs slightly at the top left and bottom right of the screen. This means that when the flash is fired, the bottom of the screen will become lighter in the field concerned and the top will become lighter in the next field. This is normal and not indicative of any problem. 	---
The brightness changes cyclically or the colors change, and horizontal stripes can be seen passing across the screen	<ul style="list-style-type: none"> • These phenomena (flicker) may occur under the illumination produced by fluorescent lighting, mercury bulbs or other types of discharge tubes. In such cases, we recommend setting the electronic shutter speed to 1/100 in regions with 50 Hz power supply frequency, and to OFF in regions with 60 Hz power supply frequency. 	---
When fine lines or cyclical patterns are shot, flickering is seen or coloring is added to them	<ul style="list-style-type: none"> • This phenomenon occurs because the pixels are arranged systematically on each image sensor. It is noticeable when the spatial frequency of a subject and the pixel pitch are brought into proximity so change the camera angle or take other action. 	---
Noise occurs in the audio input	<ul style="list-style-type: none"> • The following causes are possible. <ul style="list-style-type: none"> - The camera, switching hub, or peripheral devices are not grounded. - Power lines are running nearby. - Equipment generating strong electric or magnetic fields (e.g., television and radio antennas, air conditioning motors, power transformers) are located nearby. <p>If the problem cannot be resolved via movement of surrounding devices, use a microphone equipped with an amplifier, or connect an audio output with low output impedance.</p>	page 6

■ IP images

Symptom	Cause and solution	Reference pages
Images are not displayed	For Windows: <ul style="list-style-type: none"> • Is the plug-in viewer software installed? → Install the plug-in viewer software. 	page 29
	For Windows: <ul style="list-style-type: none"> • If [Check for newer versions of stored pages] is not set to [Every time I visit the webpage] in the temporary Internet file settings, IP images may not appear in the live screen [Live]. → Perform the following. <ol style="list-style-type: none"> ① Select [Tools] - [Internet Options] in Internet Explorer. ② Click the [General] tab, and click the [Settings] button under [Browsing history]. ③ In the [Temporary Internet Files] dialog box, select the [Every time I visit the webpage] option under [Check for newer versions of stored pages]. ④ Click the [OK] button. 	---
The images are blurry	<ul style="list-style-type: none"> • Is the focus properly adjusted? → Check the focus adjustment. 	---
Images are not updated	<ul style="list-style-type: none"> • The images may not be updated and other problems may occur depending on your web browser and its version. • The images may stop depending on the network congestion, the level of access to the unit, etc. • If the IP video settings of the unit were changed, the image display may stop temporarily. → Check the level of access to the unit, and stop any unnecessary access. Afterward, check the following. For Windows: Press the [F5] key on the personal computer's keyboard to request that the settings be acquired. For Mac: Press the [Command] + [R] key on the personal computer's keyboard to request that the settings be acquired. 	---
The images do not update or display properly	<ul style="list-style-type: none"> • Perform the following to delete the temporary Internet files. For Windows: <ol style="list-style-type: none"> ① Select [Tools] - [Internet Options] in Internet Explorer. ② Click the [General] tab, and click the [Delete] button under [Browsing history]. ③ In the [Delete Browsing History] dialog box, select the [Temporary Internet files and website files] checkbox, and then click [Delete]. ④ Click the [OK] button. For Mac: <ol style="list-style-type: none"> ① Select [Develop] - [Empty Cache] in Safari. ② Click [Empty] in the [Are you sure you want to empty the cache?] pop-up screen. 	---
	<ul style="list-style-type: none"> • The unit's ports may be filtered by the firewall or other function of the anti-virus software. → Change the HTTP port number of the unit to a port number that will not be filtered. 	---

Troubleshooting (continued)

Symptom	Cause and solution	Reference pages
H.264 images are not displayed	<ul style="list-style-type: none"> • If the “Network Camera View 4S” plug-in viewer software is deleted in an environment where the “Network Camera View 3” plug-in viewer software is installed, display of H.264 images will become impossible. In such cases, delete “Network Camera View 3” before installing “Network Camera View 4S”. 	---
	<ul style="list-style-type: none"> • Has the camera been connected to a personal computer via a router (via the Internet, for example)? → If UDP port transfer has not been set correctly, H.264 images cannot be displayed. H.264 can be transferred by HTTP when [Internet mode(Over HTTP)] is set to [On]. • Has UDP communication been blocked by security software or a firewall? → If [Internet mode(Over HTTP)] is [Off], H.264 is transferred by UDP. → Change the settings in the security software and firewall, and change the settings to permit communications with your web browser. 	page 107
The images are distorted	<ul style="list-style-type: none"> • The images may be distorted if the transmission path is congested and proper transmission is not possible. → Consult your network administrator. 	---
	<ul style="list-style-type: none"> • The images may be distorted if video packet shuffling occurs on the transmission path. → Switching to an identical Internet service provider for both the camera and the personal computer may prevent this problem. Consult your network administrator. 	---
When multiple web browsers are running to display H.264 images, images from multiple cameras appear sequentially in a single web browser	<p>For Windows:</p> <ul style="list-style-type: none"> • This may occur depending on the combination of the personal computer's display adaptor and the driver. → If this occurs, update the first display adaptor to the latest version. If this does not resolve the problem, adjust the hardware accelerator function as follows. This section describes the procedure for Windows 7 as an example. Changing the settings may not be possible, depending on your environment. ① Right-click on the desktop, and select [Screen Resolution] from the menu. ② Click [Advanced settings]. ③ Select the [Troubleshoot] tab, and click [Change setting]. ④ If the [User Account Control] dialog box appears, click [Yes]. (When logged on with an account other than an administrator account, enter the password (and user name if necessary), and click [Yes].) ⑤ Change to [Hardware acceleration] setting to [None] at the far left, and click [OK]. 	---
Audio is not output for NDI HX-compatible switchers	<ul style="list-style-type: none"> • [Audio] may be set to [Off] in the [Audio] audio setting screen. → Reset the setting to [On]. 	page 114

Troubleshooting (continued)

■ Web screen

Depending on the OS installed on the personal computer, the following may occur. Follow the instructions below when the following has occurred. Performing the following solutions will not affect the operation of other applications.

Symptom	Cause and solution	Reference pages
Frame dropping is observed in images	<ul style="list-style-type: none"> • The personal computer may be lacking in performance. → Check the requirements for the personal computer environment. 	page 8
	<ul style="list-style-type: none"> • This phenomenon may be improved by pressing the button for switching real time updating to disable the web browser real time updating function. 	page 93

For Windows:

The "information bar" described in the following explanations refers to the message bars that appear in Internet Explorer 11. The information bar appears at the bottom of Internet Explorer.

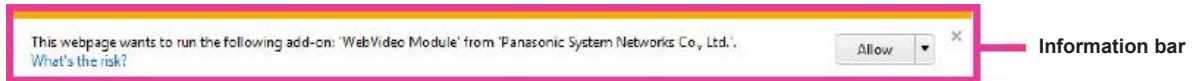

Symptom	Cause and solution	Reference pages
The following message appears in the information bar. "This website wants to run the following add-on: 'WebVideo Module' from 'Panasonic System Networks Co., Ltd.'."	<ul style="list-style-type: none"> • Select [Allow]. 	---
The following message appears in the information bar. "This website wants to install the following add-on: 'nwcV4SSetup.exe' from 'Panasonic System Networks Co., Ltd.'."	<ul style="list-style-type: none"> • Select [Install]. When the security warning window appears, click the [Install] button. 	---
An unnecessary status bar or scroll bar is displayed on the pop-up window	<ul style="list-style-type: none"> • Open the security settings screen for Internet Explorer, and select [Internet]. Click the [Custom level] button, set [Allow script-initiated windows without size or position constraints] to [Enable] under [Miscellaneous], and click the [OK] button. When the warning window appears, click the [Yes] button. 	---
The IP images do not match the display frames	<ul style="list-style-type: none"> • Images may not appear correctly if their DPI settings are 120 DPI or higher. → Right-click on the desktop of the personal computer, click [Display settings] - [Change the size of text, apps, and other items], and select [100% (Recommended)]. 	---
	<ul style="list-style-type: none"> • Images may not appear correctly if the magnification level of Internet Explorer's zoom function is not set to 100%. → Select [View] - [Zoom] in the menu bar of Internet Explorer, and click [100%]. 	---
The layout of the screen is distorted, or some buttons on the screen do not operate	<ul style="list-style-type: none"> • Select [Tools] - [Compatibility View Settings] in the menu bar of Internet Explorer, disable compatibility view for the unit. 	---

Specifications

Power requirements: 12 V DC === (10.8 V to 13.2 V)
42 V to 57 V DC === (PoE++ power supply)
Current consumption: 4 A (XLR IN connector)
1.2 A (PoE++ power supply)

 indicates safety information.

■ GENERAL

Ambient operating temperature:

0 °C to 40 °C (32 °F to 104 °F)

Storage temperature:

-20 °C to 50 °C (-4 °F to 122 °F)

Ambient operating humidity:

20% to 90% (no condensation)

Mass:

Approx. 4.2 kg (9.24 lb) (excluding mount bracket)

Dimensions (W × H × D):

213 mm × 267 mm × 219 mm
(8-3/8 inches × 10-1/2 inches × 8-5/8 inches)
(excluding protrusions, direct ceiling mount bracket)

Finish:

AW-UE150WP/AW-UE150WE: Pearl white
AW-UE150KP/AW-UE150KE: Black

Controller supported:

AW-RP150

■ INPUT

Input connector:

DC 12 V IN,
G/L IN (BNC)
• BBS (Black Burst Sync), tri-level sync supported

■ OUTPUT

Video output

HDMI:

HDMI type A
• HDCP is not supported.
• Viera Link is not supported.

12G SDI OUT:

SMPTE 2082-1/SMPTE424M / SMPTE292M /
75 Ω (BNC×1)

3G SDI OUT:

SMPTE424M / SMPTE292M /75 Ω (BNC×1)
• Level-A/Level-B supported

MONI OUT:

SMPTE292M /75 Ω (BNC×1)

OPTICAL:

SFP+ standard
Single Fiber
• The signal sent is the same as 12G SDI OUT.
• This unit does not support input by optical signals.

■ INPUT/OUTPUT

Input/Output connector

LAN:

LAN connector for IP control (RJ-45)

RS-422:

CONTROL IN RS-422A (RJ-45)

MIC/LINE input:

ø 3.5 mm stereo mini jack
Input impedance: High impedance
• During MIC input
Supported mic: Stereo mic (plug-in power,
on/off switching via menu)
Supply voltage: 2.5 V ± 0.5 V
Mic input sensitivity: Approx. -40 dBV ± 3 dBV
(0 dB=1 V/Pa, 1 kHz)
• During LINE input
Input level: Approx. -10 dBV ±3 dBV

■ FUNCTIONS AND PERFORMANCE

[Camera unit]

Imaging sensors: 1-type 4K MOS×1

Lens:

Motorized Optical 20× zoom, F2.8 to F4.5
[f=8.8 mm (11/32 inches) to 176.0 mm
(6-15/16 inches); 35 mm (1-3/8 inches)
equivalent: 24.5 mm (31/32 inches) to 490.0 mm
(19-9/32 inches)]
Extender-Zoom 1.4×

Conversion lens: Not supported

Angle of view range:

Horizontal angle of view: 75.1° (wide) to 4.0° (tele)
Vertical angle of view: 46.7° (wide) to 2.3° (tele)
Diagonal angle of view: 82.8° (wide) to 4.6° (tele)

Optical filter:

Through, 1/4, 1/16, 1/64, IR through
(IR through is used as "Night mode")

Focus:

Switching between auto and manual

Focus distance:

Entire zooming range: 1000 mm (3.3 ft)
Wide end: 100 mm (0.33 ft)

Color separation optical system:

1MOS

Minimum illumination:

2 lx (50 IRE, F2.8, 42 dB, without accumulation)

Standard sensitivity:

Shooting Mode [Normal]
F9, 2000lx
Shooting Mode [High Sens.]
F12, 2000lx

Horizontal resolution:

2000 TV lines Typ (Center area)

Gain selection:

Auto, 0 dB to 42 dB (1 dB steps)

Frame mix:

0 dB, 6 dB, 12 dB, 18 dB, 24 dB
• This cannot be configured when the format is
2160/29.97p, 2160/23.98p, 2160/24p, 2160/25p,
1080/29.97p, 1080/23.98p(59.94i), 1080/29.97PsF,
1080/23.98PsF, 1080/25p, 1080/25PsF.

Specifications (continued)

Electronic shutter speed:

- 59.94p/59.94i mode
1/60, 1/100, 1/120, 1/250, 1/500, 1/1000, 1/2000, 1/4000, 1/8000, 1/10000
- 29.97p mode
1/30, 1/60, 1/100, 1/120, 1/250, 1/500, 1/1000, 1/2000, 1/4000, 1/8000, 1/10000
- 23.98p mode
1/24, 1/48, 1/60, 1/100, 1/120, 1/250, 1/500, 1/1000, 1/2000, 1/4000, 1/8000, 1/10000
- 50p/50i mode
1/60, 1/100, 1/120, 1/250, 1/500, 1/1000, 1/2000, 1/4000, 1/8000, 1/10000
- 25p mode
1/25, 1/50, 1/60, 1/100, 1/120, 1/250, 1/500, 1/1000, 1/2000, 1/4000, 1/8000, 1/10000

Synchro scan:

- 59.94p/59.94i mode
60.00 Hz to 7200 Hz
- 29.97p mode
30.00 Hz to 7200 Hz
- 23.98p mode
24.00 Hz to 7200 Hz
- 50p/50i mode
50.00 Hz to 7200 Hz
- 25p mode
25.00 Hz to 7200 Hz

Gamma: HD/FILMLIKE1/FILMLIKE2/FILMLIKE3/
FILM REC/VIDEO REC 0.30 to 0.75

White balance: ATW: 3200K, 5600K
AWB: AWB-A/AWB-B
VAR (selectable between 2000K and 15000K by designating a value)

Chroma amount variability:
OFF, -99% to 99%

Scene file: Scene1, Scene2, Scene3, Scene4

Output format

UHD/FHD SDI:

[4K format] 2160/59.94p, 2160/50p, 2160/29.97p*1, 2160/25p*1, 2160/24p (Just), 2160/23.98p*1

[HD format] 1080/59.94p, 1080/50p, 1080/59.94i, 1080/50i, 1080/29.97p*1, 1080/23.98p*2, 1080/25p*1, 1080/29.97PsF, 1080/23.98PsF, 1080/25PsF, 1080/24p (Just), 1080/23.98p*1, 720/59.94p*3, 720/50p*3

UHD/FHD Fiber:

[4K format] 2160/59.94p, 2160/50p, 2160/29.97p*1, 2160/25p*1, 2160/24p (Just), 2160/23.98p*1

[HD format] 1080/59.94p, 1080/50p, 1080/59.94i, 1080/50i, 1080/29.97p*1, 1080/23.98p*2, 1080/25p*1, 1080/29.97PsF, 1080/23.98PsF, 1080/25PsF, 1080/24p (Just), 1080/23.98p*1, 720/59.94p*3, 720/50p*3

*1 Native output

*2 OVER 59.94i output (your monitor may recognize the signal as 59.94i).

*3 When 720/59.94p or 720/50p is selected, only 720p is output.

- When selecting formats for UHD SDI, HDMI, and Fiber, it is not possible to select different formats for each of them. Furthermore, the formats for FHD SDI and MONI OUT are fixed to the formatting method selected for UHD SDI and HDMI.

Synchronization system:

Internal/External synchronization (BBS/Tri-level sync)

[Pan-tilt head unit]

Installation method:

- Stand-alone (Desktop) or suspended (Hanging)
- To ensure safety, the unit must be secured using the mount bracket supplied.

Camera/pan-tilt head control:

IP connecting cable	LAN cable (category 5e or above), max. 100 m (328 ft)
AW protocol connecting cable	LAN cable (category 5e or above, straight cable), max. 1000 m (3280 ft)

Pan/tilt operation speed:

- Maximum speed 60°/s or higher
- Maximum speed is 180°/second or more when quietness and stopping accuracy are ignored.

Panning range: ±175°

Tilting range: -30° to 210°

- Depending on the pan or tilt position, the camera may be reflected in the image.

Quietness: NC35 or less

The symbols on this product (including the accessories) represent the following:

== DC

Index

Numerics

×1.0 button	155
3G SDI	64, 67, 96, 99, 101
3G SDI Out	63, 64, 69, 99, 100, 124
3G SDI OUT connector	16
12G SDI/OPTICAL	63, 67, 96, 98, 101
12G SDI OUT connector	17
802.1X	140
3200K	40
5600K	40

A

ABB	119
Acceleration	72, 126
Access level	130, 131
Accessories	11
Activation	149
Adaptive Matrix	54, 122
Add host	131
Address(IPv4)	112
Add user	130
Advanced	135
AGC Max Gain	47, 116
ATW	40
ATW Speed	49, 119
ATW Target B	49, 119
ATW Target R	49, 119
Audio	67, 114
Audio bit rate	114
AUDIO IN connector	17
Audio over IP	114
Audio transmission	114
Authentication	130, 139
Auto	103
Auto Iris Close Limit	46, 115
Auto Iris Speed	46, 115
Auto Iris Window	46, 115
Auto Knee Response	53, 121
Automatic installation of viewer software	104
Auto port forwarding	136
Auto tracking white adjustment	40
AVIO	75, 149
AWB	39, 118
AWB Gain Offset	48, 118

B

Backup	151
Bar	67, 101
Basic	96
B Gain	48, 49, 118
Black balance	41
Black Gamma	53, 121
Black Gamma Range	53, 121
Black level	42
B Pedestal	50, 119
Brightness	46, 47, 115
Button for displaying the Image Adjust operation screen for touch panels	152
Button for displaying the operation menu for the live screen	155
Button for displaying the Preset operation screen for touch panels	152
Button for displaying the PTZ operation screen for touch panels	152
Button for restoring the screen from the touch panel operation screen	152
Button for switching P/T Speed/Zoom	155
Button for switching PTZ/Focus	155
Button for switching real time updating	93
Button for switching the personal computer screen	93, 155
Buttons for switching the touch panel operation screen	152

C

CA Certificate	
CA Certificate install	137, 145
Generate Certificate Signing Request	137, 144
Information	137
CA Certificate install	141
Camera	45, 46, 74, 149
Camera Control	154
Camera control/Setup Menu button	115
Camera head	15
Camera ID	58, 127
Camera menu	45, 79
Camera title	104
Camera title display area	93
Check active network setting	135
Chroma Level	50, 119
Chroma Phase	50, 119
Client	128
Client(Call) port	111
Client certificate install	140
Client certificate type	140
Cloud URL	129
Color bar	90
Color Bar Type	67, 101
Color Correction	55, 56, 122
Color Setting	57, 96, 97
Color Temperature	48, 49, 118
Color Temperature Setting	118
Color TEMP. Setting	48, 49
COM	75, 149
Common	133
Common setup	111
Compression	90
Config data type	151
Connect	77
Connection	137, 145
Connection type	127
Contact	139
Control Area	155
Control pad and its buttons	92
CPU Software	74, 149
Crop Adjust	69
Crop Adjust Select	124
Crop H Position	69
Crop Marker	69
Crop Marker Select	124
Crop Mode	123
Crop Out	69
Crop Output PTZ	123
Crop Output Select	124
Crop V Position	69
CRT key generate	137, 143

D

Date & Time	148
Date/Time	103
Date&Time	103
Day/Night	48, 116
DC. Detail Coring	51, 120
DC. Detail Frequency	51, 120
DC IN connector	17
DC. Knee Aperture Level	52, 120
DC. Level Depend.	52, 120
DC. Master Detail	51, 120
DC. V Detail Level	51, 120
Default gateway	132, 133
Default Gateway	75
Default reset	150
Delete host	131
Delete user	130
Description	148
Destination IP address(IPv4)	111
Destination port	111

Index (continued)

Detail	50, 119
Detail Coring	50, 119
Detail Frequency	50, 119
Detail Gain(-)	50, 119
Detail Gain(+)	50, 119
DHCP	132
DHCPv6	133
Digital Extender	57, 123
DNR	54, 121
DNS	133
DownCon Detail	51, 120
Download	151
Drop-prevention wire	15
DRS	53, 121

E

EAP authentication method	140
Easy IP Setup accommodate period	134
Easy IP Setup Software	28
Easy IP Setup Tool Plus	141
EasyIP Setup Tool Plus	28
EEPROM	75, 149
ELC Limit	47, 116
Encryption	111
Encryption method	139
Error code	148
Error description	148
Error log	148
Error Status	74, 78
Event code	148
Event log	148
Expansion panel display button	89
External Output	68, 102
External sync signal input format	17

F

Fan	78, 96, 97
Fan1	59, 76, 96, 97
Fan2	59, 76, 96, 97
Firmware file	149
Firmware version	149
Firmware Version	74, 75, 95
Flip Detect Angle	71, 102
Focus	37, 92
Focus Adjust With PTZ.	71, 96, 103, 126
Focus (AUTO)/Iris (AUTO) button	155
Focus Mode	57, 123
Format	57, 60, 63, 64, 65, 66, 77, 96, 98, 99, 100, 101
FPGA	75, 149
Frame Mix	47, 116
Frame rate	107, 109
F-REC Black STR. Level	52, 120
F-REC Dynamic Level	52, 120
Freeze During Preset	73, 127
Frequency	57, 60, 96
Full-screen display button	93

G

G	68, 102
Gain	37, 47, 93, 116
Gamma	52, 120
Gamma Mode	52, 120
G Axis	49, 118
Genlock	43, 57, 96, 97
G/L IN connector	17
G Pedestal	50, 119
Ground connector	17
Grounding	6
Group	112

H

H.264	104, 107
H.264 transmission	107
H.265	104, 109
H.265 transmission	109
HDMI	66, 67, 96, 101
HDMI connector	16
HDMI Status	74, 77
HDR Output	77
HDR Output Select	63, 64, 65, 66, 99, 100, 101
HLG Knee	53, 121
HLG Knee Point	53, 121
HLG Knee Slope	53, 121
Hole for securing the camera pedestal	15
Home button	155
Horizontal Phase	57, 96, 97
Horizontal phase adjustment	43
Host auth.	131
Host IP address	131
Hour Meter	74, 76
HTTP max segment size (MSS)	133
HTTP port	133
HTTP Port number	135
HTTPS	137, 142, 145
HTTPS mode	138
HTTPS port	138
HTTPS Port number	135
HTTPS Status	135
HTTP Status	135

I

Image adjust	115
Image adjust operation area for touch panels	153
Image/Audio	104
Image capture size	106, 107, 109
Image quality	106, 108
Index number	139
Initial account	29, 87
Initial display setting	104, 105
initialization	76
Initialize	74, 76
Input Type	67, 114
Install Position	71, 96, 102
Interface	74, 75, 149
Internet mode(Over HTTP)	107
Invert Pan/Tilt Axis	58, 128
IP	58, 67, 101
IP address	131
IP Address	75
IP address(IPv4)	128, 132
IP address(IPv6)	133
IP Network	74, 75
IP out	128
IP Out	69, 124
IP(UDP)	128
IPv4 network	132
IPv6 network	133
IP video transmission output	19
IR ID switches	17, 27
Iris	37, 92
Iris Mode	46, 115

J

JPEG	104, 106
JPEG transmission	106

K

Knee Aperture Level	50, 119
Knee Mode	53, 121
Knee Point	53, 121
Knee Slope	53, 121

Index (continued)

-
- ### L
- LAN connector for IP control 15
 - Latency 111
 - Lens 46, 57, 74, 78, 123, 149
 - Level Depend. 50, 119
 - Limitation Setting 126
 - Limiters 156, 157
 - Linear Matrix 55, 122
 - Linkage 127
 - Live 88, 89
 - Live page 104
 - Location 139
 - Lock 91
-
- ### M
- MAC address 149
 - Main area 91
 - Main/Network 74, 75, 149
 - Maintenance 45, 74, 148
 - Manual 103, 133
 - Manual shooting 37
 - Master Detail 50, 119
 - Master pedestal 42
 - Master Pedestal 50, 119
 - Matrix 46, 54, 55, 56, 122
 - Matrix Settings 122
 - Matrix Type 54, 122
 - Max bit rate(per client) 108, 109
 - Max Digital Zoom 57, 123
 - Max RTP packet size 133
 - mDNS 140
 - Mode 102, 105, 111, 129, 130, 131
 - Model no. 95, 149
 - MONI 65, 67, 96, 100, 101
 - Monitor 77
 - MONITOR OUT connector 17
 - Mount bracket for installation surface 15
 - MPEG2-TS over UDP 113
 - Multicast address 108, 109
 - Multicast address(IPv4) 113
 - Multicast port 108, 109
 - Multicast Port 113
 - Multicast Transmit 112
 - Multicast TTL/HOPLimit 108, 109, 113
-
- ### N
- Name 112
 - ND 93
 - ND Filter 48, 116
 - NDI|HX V2 112
 - Network 132
 - No. 148
 - NTP 103, 136
 - NTP port 136
 - NTP server address 136
 - NTP server address setting 136
-
- ### O
- OIS 57, 123
 - Operation 76
 - Operation screen display buttons 89
 - Operation time 148, 149
 - Optical connector 17
 - Optional accessories 11
 - OSD Menu 90
 - OSD Mix 67, 101
 - OSD Off With R-Tally 68, 102
 - OSD Status 68, 102
 - OSS license display 149
 - Other Menu 90
-
- ### Output
- Output 45, 63, 64, 65, 66, 67, 68, 69, 96, 98
 - Output1 68, 102
 - Output2 68, 102
 - Output client select 128
 - Output conditions for each video format 18
-
- ### P
- P2 Cast 129
 - Pan/Tilt 45, 71, 78, 96, 102
 - Pan/Tilt Lens Control 126
 - Passphrase 111
 - Password 129, 130, 139, 141
 - PC Synchronization 103
 - PEAP 141
 - Pedestal Offset 50, 119
 - Phase 55, 56, 122
 - Picture 46, 48, 50, 51, 52, 53, 54, 117
 - Picture Level 46, 115
 - Plain text usage 141
 - Plugin Power 67, 114
 - Plug-in viewer software 29
 - Port 129
 - Power 31
 - Power ON 91
 - Power On Position 71, 103
 - Preset 45, 72, 73, 92, 125
 - Preset Acceleration 72, 126
 - Preset Crop 72, 126
 - Preset Digital Extender 72, 126
 - Preset Iris 73, 127
 - Preset memory 38
 - Preset Name 73, 127
 - Preset Number 71, 103
 - Preset operation area for touch panels 153
 - Preset position 125
 - Preset Scope 72, 126
 - Preset Setting 126
 - Preset Speed 72, 126
 - Preset Speed Table 72, 126
 - Preset Speed Unit 72, 126
 - Preset thumbnail list display button 93
 - Preset thumbnail operation area 155
 - Preset Thumbnail Update 73, 127
 - Preset Zoom Mode 73, 127
 - Primary server address 133
 - Private Key password 140
 - Private Key password usage 140
 - Product info. 149
 - Protocol 112
 - P/T Speed Mode 71, 96, 102
 - P/T Speed/Zoom operation area 155
 - PTZ/Focus operation area 155
 - PTZ operation area for touch panels 152
 - Push UDP 113
-
- ### R
- R 68, 102
 - Reboot 150
 - Recommended network setting for internet 134
 - Referrer check 139
 - Refresh interval 106
 - Remote control IDs 27
 - Reset to the default (Except the network settings) 150
 - Retype password 130
 - R Gain 48, 49, 118
 - Router global address 135
 - R Pedestal 50, 119
 - RS-422 connector 16
 - RTMP 110
 - RTSP 138
 - RTSP port 138
 - RTSP request URL 138

Index (continued)

-
- ### S
- Safe mode 158
 - Saturation 55, 56, 122
 - Scene 46, 93, 115
 - Scene file 33
 - Secondary server address 133
 - Security certificate 146
 - Self-signed Certificate
 - Generate 137, 143
 - Information 137
 - Serial 58, 127
 - Serial no. 149
 - Server address(IPv4) 112
 - Server setup 110
 - Server URL 110
 - Service switches 16
 - Servo 74, 149
 - Set Execute 75
 - Setting status 95, 104, 114, 127, 130, 131, 135
 - Setup 44, 88, 94
 - Shooting 30, 34
 - Shooting mode 33
 - Shooting Mode 57, 96, 97
 - Shutter 93
 - Shutter Mode 47, 116
 - Shutter speed 37
 - Skin Detail 51, 119
 - Skin Detail Effect 51, 119
 - Smart Picture Flip 71, 96, 102
 - Smoother live video display on the browser(buffering) 104
 - Snapshot button 93
 - Snapshot button for touch panels 152
 - SNMP 139
 - Source name 112
 - Speed 92
 - Speed With Zoom Position 71, 96, 103, 126
 - SRT 111
 - SRT/MPEG2-TS/RTMP 93
 - SRT/MPEG2-TS/RTMP operation area for touch panels 152
 - Standby 91
 - Status display lamp 15
 - Status Lamp 68, 102
 - Step/Synchro 47, 116
 - Stream 90, 105
 - Stream ID 111
 - Streaming format 110, 111, 112, 113
 - Streaming mode 95, 104, 105
 - Stream key 110
 - Stream Menu 90
 - Subnet(IPv4) 112
 - Subnet mask 132
 - Subnet Mask 75
 - Super Gain 47, 116
 - Synchronization with NTP 136
 - System 45, 57, 58, 96
 - System Format 95
 - System Frequency 95
 - System log 148
 - System name 139
 - System status 96
 - System Version 74
-
- ### T
- Tally 68, 102
 - Tally Brightness 68, 102
 - Tally lamp 15
 - Tally LED Limit 68, 102
 - Temperature 78
 - Tilt head 15
 - Time adjustment interval 136
 - Time Zone 103
 - TLS 140
 - TLS User name 140
 - Tone 67, 101
 - Top Menu 45
-
- ### Tracking data output 61
- Tracking Data Output 58, 127
 - Transmission priority 107
 - Transmission type 108, 109, 113
 - Tripod screw holes 17
 - TSL5.0 139
 - TSL5.0 Port 139
 - TTL/HOP Limit 111, 112
-
- ### U
- UHD Crop 69, 123
 - Unicast address(IPv4) 113
 - Unicast Port 113
 - Unicast port(Audio) 108, 109
 - Unicast port(Image) 108, 109
 - Upload 151
 - UPnP 136
 - URL 110
 - URL type 110
 - Use discovery server 112
 - User auth. 130
 - User ID 129
 - User mng. 130
 - User name 130, 139, 141
-
- ### V
- VAR 40
 - V Detail Level 50, 119
 - Ventilation holes 17
 - Video over IP 104
 - Video Sampling 66, 77, 101
 - Viewer software installation counter 149
 - V-Log Output Select 63, 64, 65, 66, 99, 100, 101
 - Volume Level 67, 114
 - V-REC Knee Point 52, 120
 - V-REC Knee Slope 52, 120
-
- ### W
- WB 93
 - Web screen 86
 - White balance 39
 - White Balance Mode 48, 49, 118
 - White Clip 54, 121
 - White Clip Level 54, 121
 - Wireless Control 59, 96, 97
 - Wireless remote control 14, 25, 27
 - Wireless remote control signal light-sensing area 15
-
- ### X
- X 124
-
- ### Y
- Y 124
-
- ### Z
- Zoom 92
 - Zoom Mode 57, 123

Panasonic Connect Co., Ltd.

Web Site: <https://pro-av.panasonic.net/en/>

© Panasonic Connect Co., Ltd. 2018 - 2022